

100% MADE IN ITALY



Milano2015
12



Milano2015.p
18



Italia 150
22



Go!
30



Rap
38



Rap.tt
46

index

chairs, tables & co.



Rapper
52



Rap.w
60



Rap Wood
64



Hip
76



Bip
90



Bip Iron
100



Brera
104



Dandy
112



Dandy.tt
116



Dandy.w
118



Dandy.b
120



Dandy Iron
124



Odyssee.m
140



Odyssee
142



Odyssee.xl
146



Diana
152



Diana.f
156



Grace
160



Grace.p
166



Giò
172



Waiya
180



Waiya.p
186



Jackie
194



Dress_Dress Up
200



Karlotta_Karlotta.p
206



Karla
208





Rap.ss
40



Rapper.ss
56



Rap Wood.ss
70



Jack_JackJr
72



Hip.ss
80



Joker
86



Bip.ss
96



Bip Iron.ss
102



Brera.ss
108



Dandy iron.ss
128



Dandy swing
130



Pedalò
134



Diana.ss
154



Diana.f.ss
158



Waiya.ss
184



Waiya.p.ss
190



Jackie.ss
198

Tavoli_Tables



Circus
212



V6
220



Cargo
226



Slash
234



Skin
240



Oste
244



Level
248



Pure
258



Piet
264



Star
268



Acqua Alta Bistrot
274



Teorico
280

Living



Can Can
286



Asami_Asami Iron
294

daybyday

prodotti leggeri, per l'uso quotidiano,
senza perdere di vista gusto,
resistenza e amore per il design
light products, for everyday use,
without losing sight for taste,
resistance and love for design

Milano2015

design W.Colico & Bestetti Associati

Sedia in polipropilene soft touch, policarbonato trasparente o policarbonato coprente disponibile in un'ampia gamma colori. Realizzata in materiale riciclabile, la sedia è impilabile ed adatta ad uso esterno.

Chair in soft touch polypropylene, transparent polycarbonate or glossy polycarbonate available in a wide range of colours. Made of recyclable material, the chair is stackable and suitable for outdoor.

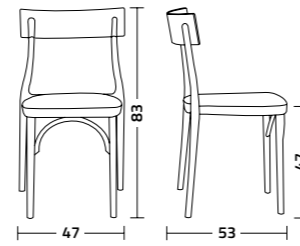

polipropilene - polypropylene

- 9003 bianco zucchero
sugar white
- 1019 beige tortora
taupe beige
- 1027 giallo senape
mustard yellow
- 2001 arancione ruggine
rust orange
- 3002 rosso rubino
ruby red
- 5014 azzurro avio
steel blue
- 6003 verde felce
fern green
- 8019 marrone caffè
coffee brown
- 7045 grigio silver
Silver grey
- 7024 grigio antracite
charcoal grey

policarbonato trasparente transparent polycarbonate

- 0001 trasparente
transparent
- 0060 giallo ambr
amber yellow
- 3002 rosso rubino
ruby red
- 0061 verde bottiglia
bottle green
- 0063 grigio fumé
smoky grey

policarbonato coprente glossy polycarbonate

- 9003 bianco zucchero
sugar white
- 0111 giallo sole
sun yellow
- 3016 rosso rubino
ruby red
- 3949 blu majorelle
majorelle blue
- 7037 grigio fango
taupe grey
- 9005 nero assoluto
absolute black



Sedia Milano2015 in polipropilene soft touch, colore azzurro avio.
Milano2015 chair in soft touch polypropylene, steel blue colour.



Sedia Milano2015 in polipropilene soft touch, colore rosso rubino.
Milano2015 chair in soft touch polypropylene, ruby red colour.



Impilate, sedie Milano2015 in polipropilene soft touch,
colore arancione ruggine e marrone caffè.
Stacked, Milano2015 chairs in soft touch polypropylene,
rust orange and coffee brown colour.



Milano2015 è
Milano2015 is



impilabile
stackable



resistente raggi UV
per interni/esterni
UV resistant
out/indoor



riciclabile
recyclable



made
in Italy

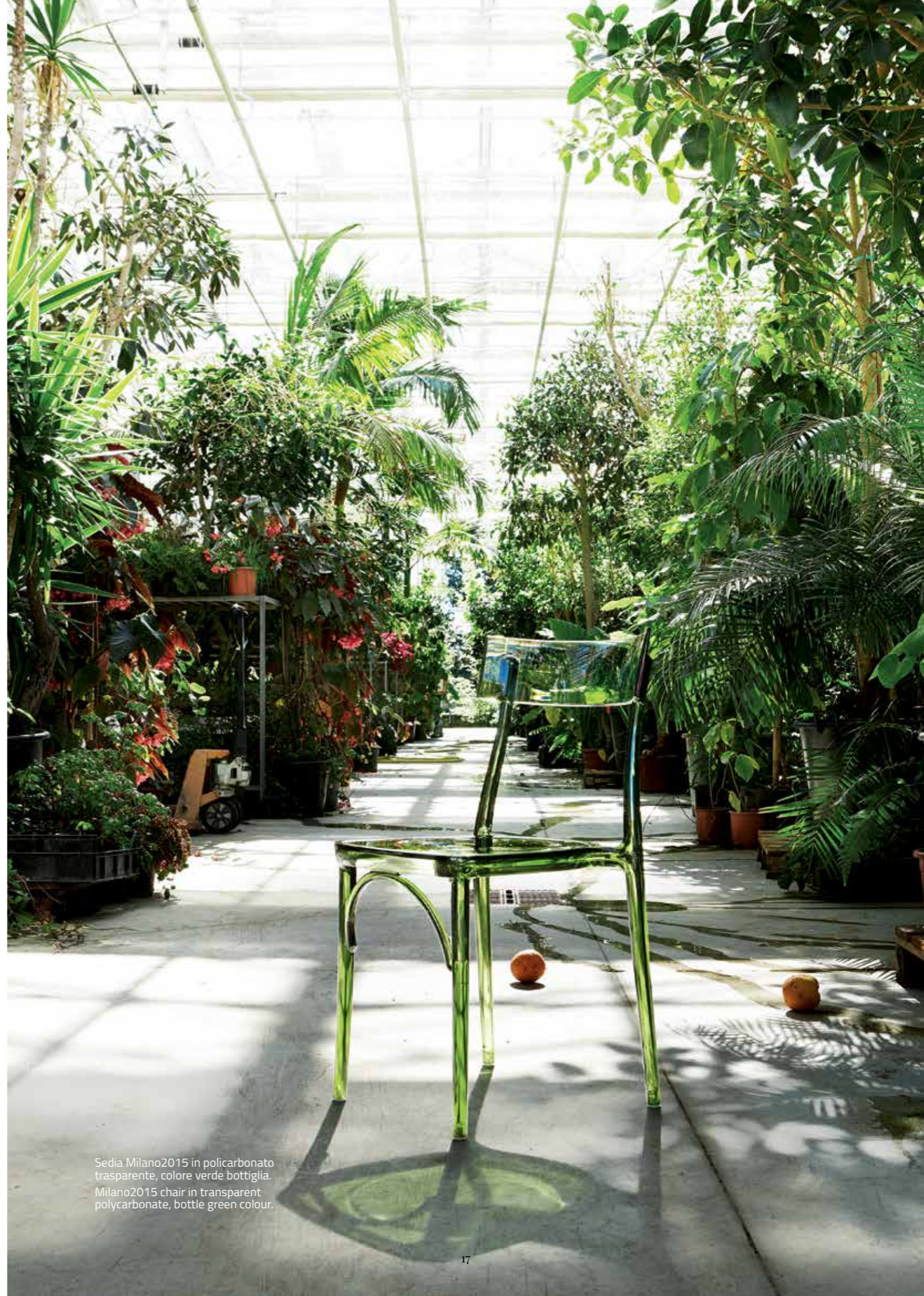

Sedia Milano2015 in policarbonato
trasparente, colore verde bottiglia.
Milano2015 chair in transparent
polycarbonate, bottle green colour.

Milano2015.p

design W.Colico & Bestetti Associati

Poltroncina in polipropilene soft touch, policarbonato trasparente o policarbonato coprente disponibile in un'ampia gamma colori e realizzata in materiale riciclabile. La sedia è impilabile ed è caratterizzata dall'originale bracciolo in legno di frassino naturale o laccato.

Armchair in soft touch polypropylene, transparent polycarbonate or glossy polycarbonate available in a wide range of colours and made of recyclable material. The chair is stackable and characterized by its original armrest in natural or lacquered ash wood.

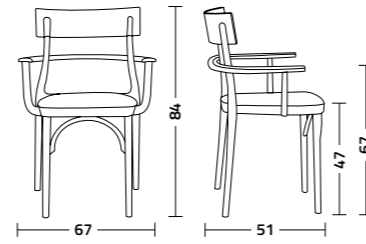

Poltroncina Milano2015.p in policarbonato coprente, colore nero assoluto e bracciolo in legno di frassino laccato, nello stesso colore.
Milano2015.p armchair in glossy polycarbonate, absolute black colour and lacquered ash wood armrest, in the same colour.

polipropilene - polypropylene

- 9003 bianco zucchero
sugar white
- 1019 beige tortora
taupe beige
- 1027 giallo senape
mustard yellow
- 2001 arancione ruggine
rust orange
- 3002 rosso rubino
ruby red
- 5014 azzurro avio
steel blue
- 6003 verde felce
fern green
- 8019 marrone caffè
coffee brown
- 7045 grigio silver
silver grey
- 7024 grigio antracite
charcoal grey

**policarbonato trasparente
transparent polycarbonate**

- 0001 trasparente
transparent
- 0060 giallo ambra
amber yellow
- 3002 rosso rubino
ruby red
- 0061 verde bottiglia
bottle green
- 0063 grigio fumé
smoky grey

**policarbonato coprente
glossy polycarbonate**

- 9003 bianco zucchero
sugar white
- 0111 giallo sole
sun yellow
- 3016 rosso rubino
ruby red
- 3949 blu majorelle
majorelle blue
- 7037 grigio fango
taupe grey
- 9005 nero assoluto
absolute black

**bracciolo - armrest
frassino - ash**

- 0001 naturale
natural
- 0002 smoke
smoke
- 9005 nero assoluto
absolute black





Impilate, poltroncine Milano2015.p in policarbonato coprente, colore giallo sole, grigio fango e bianco zucchero; tutte con bracciolo in legno di frassino naturale.
Stacked, Milano2015.p armchairs in glossy polycarbonate, sun yellow, taupe grey and sugar white colour; all with natural ash wood armrest.



Poltroncina Milano2015.p in policarbonato coprente, colore giallo sole e bracciolo in legno di frassino naturale.
Milano2015.p armchair in glossy polycarbonate, sun yellow colour and natural ash wood armrest.

Italia150

Design W.Colico & Bestetti Associati

Sedia in polipropilene soft touch, disponibile in diversi colori. Realizzata in materiale riciclabile, la sedia è impilabile ed adatta ad uso esterno.

Chair in soft touch polypropylene, available in different colours. Made of recyclable material, the chair is stackable and suitable for outdoor.

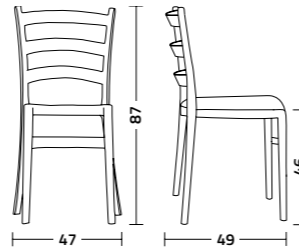

polipropilene - polypropylene

- 9003 bianco zucchero
sugar white
- 9001 beige lino
linen beige
- 1019 beige tortora
taupe beige
- 1027 giallo senape
mustard yellow
- 3002 rosso rubino
ruby red
- 5014 azzurro avio
steel blue
- 6003 verde felce
fern green
- 7037 grigio fango
taupe grey



Nella pagina accanto:
sedie Italia150 in polipropilene
soft touch, colore rosso rubino
e beige tortora.

On the next page:
Italia150 chairs in soft touch
polypropylene, ruby red and
taupe beige colour.



Dettaglio, sedia Italia150 in polipropilene soft touch, colore grigio fango.
Detail, Italia150 chair in soft touch polypropylene, taupe grey colour.



Sedie Italia 150 in polipropilene soft touch; gamma colori.
ft. tavolo Pure.
Italia 150 chairs in soft touch polypropylene; colour range.
ft. Pure table.



Sedie Italia150 in polipropilene soft touch,
colore azzurro avio e verde felce.

Italia150 chairs in soft touch polypropylene,
steel blue and fern green colour.



daybyday product

Go!

Design W&D

Sedia in polipropilene soft touch, disponibile in diversi colori. Realizzata in materiale riciclabile, la sedia è impilabile ed adatta ad uso esterno.

Chair in soft touch polypropylene, available in different colours. Made of recyclable material, the chair is stackable and suitable for outdoor.

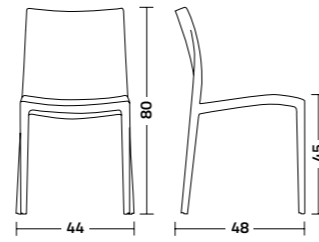

polipropilene - polypropylene

- 9003 bianco zucchero
sugar white
- 1019 beige tortora
taupe beige
- 7037 grigio fango
taupe grey
- 7024 grigio antracite
charcoal grey
- 9005 nero assoluto
absolute black



Sedia Go! in polipropilene soft touch,
colore nero assoluto.
Go! chair in soft touch polypropylene,
absolute black colour.



Sedia Go! in polipropilene soft touch, colore grigio fango.
Go! chair in soft touch polypropylene, taupe grey colour.



Sedia Go! in polipropilene soft touch,
colore grigio antracite.
ft. tavolo Pure.
Go! chairs in soft touch polypropylene,
charcoal grey colour.
ft. Pure table.



Sedia Go! in polipropilene soft touch,
colore grigio fango.
Go! chair in soft touch polypropylene,
taupe grey colour.



Impilate, sedie Go! in polipropilene soft
touch; gamma colori.
Stacked, Go! chair in soft touch
polypropylene; colour range.

Rap_Rap.ss_Rap.tt_Rapper
Rapper.ss_Rap.w_Rap Wood_Rap Wood.ss



Rap...

Rap

Design F. di Martino

Sedia impilabile con struttura in acciaio cromato o verniciato e seduta realizzata in polipropilene soft touch, materiale riciclabile e disponibile in diversi colori. La seduta può essere rivestita in tessuto o ecopelle.

Stackable chair with painted or chrome-plated steel frame and seat made of soft touch polypropylene, recyclable material available in different colours. The seat can be upholstered with fabric or artificial leather.

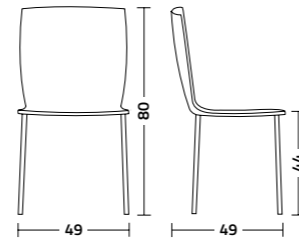

struttura - frame acciaio - steel

-  9003 bianco zucchero sugar white
-  7032 beige champagne champagne beige
-  1019 beige tortora beige taupe
-  7024 grigio antracite charcoal grey
-  7022 grigio piombo lead grey
-  9005 nero assoluto absolute black
-  0070 cromo chrome

seduta - seat tessuto - fabric fiocco

-  0206 beige canapa hemp beige
-  8008 rosa corallo coral pink
-  9260 arancione ruggine rust orange
-  3103 rosso scarlatto scarlet red
-  6714 verde mirto brunswick green
-  5667 verde ottanio teal green
-  5554 viola indaco indigo violet
-  4765 marrone glacé glacé brown
-  0408 grigio antracite charcoal grey
-  0802 nero assoluto absolute black

seduta - seat polipropilene - polypropylene

-  9003 bianco zucchero sugar white
-  1019 beige tortora beige taupe
-  7024 grigio antracite charcoal grey
-  9005 nero assoluto absolute black

seduta - seat ecopelle - artificial leather magnum

-  102 bianco zucchero sugar white
-  118 beige tortora beige taupe
-  113 grigio fango beige taupe
-  129 rosso scarlatto scarlet red
-  110 marrone caffè coffee brown
-  126 grigio silver silver grey
-  120 grigio antracite charcoal grey
-  101 nero assoluto absolute black

seduta - seat tessuto - fabric vivido

-  03 grigio tortora taupe grey
-  59 rosa pastello pastel pink
-  57 rosso borgogna burgundy red
-  42 verde marino marine green
-  05 grigio antracite charcoal grey
-  32 nero assoluto absolute black

seduta - seat ecopelle - artificial leather vintage

-  004 marrone noce walnut brown
-  007 marrone glacé glacé brown
-  002 grigio antracite charcoal grey
-  001 nero assoluto absolute black

seduta - seat tessuto - fabric magico

-  01 bianco avorio ivory white
-  11 giallo senape mustard yellow
-  03 beige avana fallow beige
-  02 beige canapa hemp beige
-  04 marrone glacé glacé brown
-  05 grigio silver silver grey
-  06 grigio ardesia slate grey

seduta - seat ecopelle - artificial leather econabuk

-  79 giallo senape mustard yellow
-  29 rosso rubino ruby red
-  60 verde menta mint green
-  15 grigio perla pearl grey
-  44 grigio antracite charcoal grey
-  43 nero assoluto absolute black



Sedie Rap con struttura in acciaio verniciato e seduta in polipropilene soft touch, colore nero assoluto e bianco zucchero.

Rap chairs with painted steel frame and soft touch polypropylene seat, absolute black and sugar white colour.



Rap.ss

Design F. di Martino

Sgabello con base in alluminio verniciato o cromato; la struttura, girevole e regolabile in altezza tramite pistone a gas, è realizzata in acciaio verniciato o cromato, mentre la seduta è in polipropilene soft touch, materiale riciclabile e disponibile in diversi colori, e può essere rivestita in tessuto o ecopelle.

Stool with painted or chrome-plated aluminium base; the frame, swiveling and height-adjustable through a gas piston, is made of painted or chrome-plated steel, while the seat is in soft touch polypropylene, recyclable material available in different colours, and can be upholstered in fabric or artificial leather.

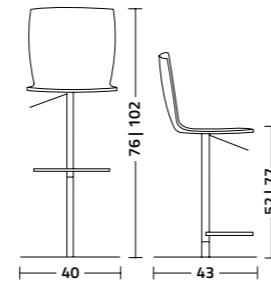

base - base
alluminio - aluminium
struttura - frame
acciaio - steel

- 9003 bianco zucchero sugar white
- 1019 beige tortora taupe beige
- 7032 beige champagne champagne beige
- 7022 grigio piombo lead grey
- 7024 grigio antracite charcoal grey
- 9005 nero assoluto absolute black
- 0070 cromo chrome

seduta - seat
polipropilene - polypropylene

- 9003 bianco zucchero sugar white
- 1019 beige tortora taupe beige
- 7024 grigio antracite charcoal grey
- 9005 nero assoluto absolute black

seduta - seat
tessuto - fabric
vivido

- 03 grigio tortora taupe grey
- 59 rosa pastello pastel pink
- 57 rosso borgogna burgundy red
- 42 verde marino marine green
- 05 grigio antracite charcoal grey
- 32 nero assoluto absolute black

seduta - seat
tessuto - fabric
magico

- 01 bianco avorio ivory white
- 11 giallo senape mustard yellow
- 03 beige avana fallow beige
- 02 beige canapa hemp beige
- 04 marrone glacé glacé brown
- 05 grigio silver silver grey
- 06 grigio ardesia slate grey

seduta - seat
tessuto - fabric
fiocco

- 0206 beige canapa hemp beige
- 8008 rosa corallo coral pink
- 9260 arancione ruggine rust orange
- 3103 rosso scarlatto scarlet red
- 6714 verde mirto brunswick green
- 5667 verde ottanio teal green
- 5554 viola indaco indigo violet
- 4765 marrone glacé glacé brown
- 0408 grigio antracite charcoal grey
- 0802 nero assoluto absolute black

seduta - seat
tessuto - fabric
magnum

- 102 bianco zucchero sugar white
- 118 beige tortora taupe beige
- 113 grigio fango taupe grey
- 129 rosso scarlatto scarlet red
- 110 marrone caffè coffee brown
- 126 grigio silver silver grey
- 120 grigio antracite charcoal grey
- 101 nero assoluto absolute black

seduta - seat
tessuto - fabric
vintage

- 004 marrone noce walnut brown
- 007 marrone glacé glacé brown
- 002 grigio antracite charcoal grey
- 001 nero assoluto absolute black

seduta - seat
tessuto - fabric
econabuk

- 79 giallo senape mustard yellow
- 29 rosso rubino ruby red
- 60 verde menta mint green
- 15 grigio perla pearl grey
- 44 grigio antracite charcoal grey
- 13 nero assoluto absolute black



Sgabelli Rap.ss con base in alluminio e struttura in acciaio verniciato, colore grigio antracite e pistone in acciaio cromato; seduta in polipropilene soft touch, colore grigio antracite.

Rap.ss stools with painted aluminium and steel frame, charcoal grey colour and chrome-plated steel piston; soft touch polypropylene seat, charcoal grey colour.

Dettaglio e scatto frontale, sgabello Rap.ss con struttura e pistone in acciaio verniciato, colore nero assoluto; seduta in polipropilene soft touch rivestita in ecopelle, Econabuk, colore grigio perla.

Detail and front shoot, Rap.ss stool with painted steel frame and piston, absolute black colour; soft touch polypropylene seat upholstered with artificial leather, Econabuk, pearl grey colour.





Sgabelli Rap.ss con base in alluminio, struttura e pistone in acciaio verniciato, seduta in polipropilene soft touch, colore nero assoluto e bianco zucchero.
 Rap.ss stools with painted aluminium base, steel frame and piston, soft touch polypropylene seat, absolute black and sugar white colour.



Dettaglio, sgabello Rap.ss con base in alluminio e struttura in acciaio verniciato, colore grigio antracite e pistone in acciaio cromato; seduta in polipropilene soft touch, colore grigio antracite.

Detail, Rap.ss stool with painted aluminium and steel frame, charcoal grey colour and chrome-plated steel piston; soft touch polypropylene seat, charcoal grey colour.

Rap.tt

Design F. di Martino

Sedia con struttura in acciaio verniciato e seduta realizzata in polipropilene soft touch, materiale riciclabile e disponibile in diversi colori. La seduta può essere rivestita in tessuto o ecopelle.

Chair with painted steel frame and seat made of soft touch polypropylene, recyclable material available in different colours. The seat can be upholstered with fabric or artificial leather.

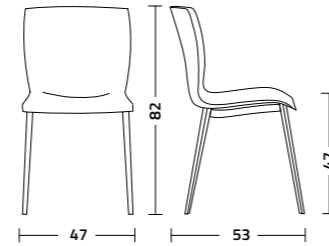

struttura - frame
acciaio - steel

- 9003 bianco zucchero sugar white
- 7032 beige champagne champagne beige
- 7022 grigio piombo lead grey
- 9005 nero assoluto absolute black

seduta - seat
polipropilene - polypropylene

- 9003 bianco zucchero sugar white
- 1019 beige tortora taupe beige
- 7024 grigio antracite charcoal grey
- 9005 nero assoluto absolute black

- seat
tessuto - fabric
vivido

- 03 grigio tortora taupe grey
- 59 rosa pastello pastel pink
- 57 rosso borgogna burgundy red
- 42 verde marino marine green
- 05 grigio antracite charcoal grey
- 32 nero assoluto absolute black

seduta - seat
tessuto - fabric
magico

- 01 bianco avorio ivory white
- 11 giallo senape mustard yellow
- 03 beige avana fallow beige
- 02 beige canapa hemp beige
- 04 marrone glacé glacé brown
- 05 grigio silver silver grey
- 06 grigio ardesia slate grey

seduta - seat
tessuto - fabric
fiocco

- 0206 beige canapa hemp beige
- 8008 rosa corallo coral pink
- 9260 arancione ruggine rust orange
- 3103 rosso scarlatto scarlet red
- 6714 verde mirto brunswick green
- 5667 verde ottanio teal green
- 5554 viola indaco indigo violet
- 4765 marrone glacé glacé brown
- 0408 grigio antracite charcoal grey
- 0802 nero assoluto absolute black

seduta - seat
ecopelle - artificial leather
magnum

- 102 bianco zucchero sugar white
- 118 beige tortora taupe beige
- 113 grigio fango taupe grey
- 129 rosso scarlatto scarlet red
- 110 marrone caffè coffee brown
- 126 grigio silver silver grey
- 120 grigio antracite charcoal grey
- 101 nero assoluto absolute black

seduta - seat
ecopelle - artificial leather
vintage

- 004 marrone noce walnut brown
- 007 marrone glacé glacé brown
- 002 grigio antracite charcoal grey
- 001 nero assoluto absolute black

seduta - seat
ecopelle - artificial leather
econabuk

- 79 giallo senape mustard yellow
- 29 rosso rubino ruby red
- 60 verde menta mint green
- 15 grigio perla pearl grey
- 44 grigio antracite charcoal grey
- 13 nero assoluto absolute black



Sedia Rap.tt con struttura in acciaio verniciato, colore grigio piombo e seduta in polipropilene soft touch, colore nero assoluto. Rap.tt chair with painted steel frame, lead grey colour and soft touch polypropylene seat, absolute black colour.





Dettaglio e scatto laterale, sedia Rap.tt
con struttura in acciaio verniciato, colore grigio piombo
e seduta in polipropilene soft touch, colore nero assoluto.
Detail and side shoot, Rap.tt chair with painted steel frame,
lead grey colour and soft touch polypropylene seat,
absolute black colour.



Sedia Rap.tt con struttura in acciaio verniciato, colore grigio piombo e seduta in polipropilene soft touch rivestita in ecopelle, Econabuk, colore grigio perla.

Rap.tt chair with painted steel frame, lead grey colour and soft touch polypropylene seat upholstered with artificial leather, Econabuk, pearl grey colour.



Rapper

Design F. di Martino

Sedia con struttura in tondino di acciaio verniciato e seduta realizzata in polipropilene soft touch, materiale riciclabile e disponibile in diversi colori. La seduta può essere rivestita in tessuto o ecopelle.

Chair with painted steel rod frame and seat made of soft touch polypropylene, recyclable material available in different colours. The seat can be upholstered with fabric or artificial leather.

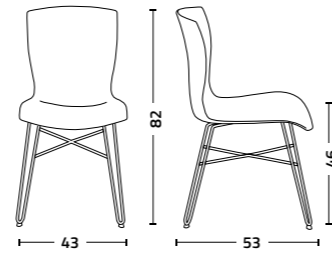

struttura - frame
tondino di acciaio - steel rod

- 9003 bianco zucchero sugar white
- 9005 nero assoluto absolute black

seduta - seat
polipropilene - polypropylene

- 9003 bianco zucchero sugar white
- 1019 beige tortora taupe beige
- 7024 grigio antracite charcoal grey
- 9005 nero assoluto absolute black

seduta - seat
tessuto - fabric

- 03 grigio tortora taupe grey
- 59 rosa pastello pastel pink
- 57 rosso borgogna burgundy red
- 42 verde marino marine green
- 05 grigio antracite charcoal grey
- 32 nero assoluto absolute black

seduta - seat
tessuto - fabric

- 01 bianco avorio ivory white
- 11 giallo senape mustard yellow
- 03 beige avana fallow beige
- 02 beige canapa hemp beige
- 04 marrone glacé glacé brown
- 05 grigio silver silver grey
- 06 grigio ardesia slate grey

seduta - seat
tessuto - fabric

- 0206 beige canapa hemp beige
- 8008 rosa corallo coral pink
- 9260 arancione ruggine rust orange
- 3103 rosso scarlatto scarlet red
- 6714 verde mirto brunswick green
- 5667 verde ottanio teal green
- 5554 viola indaco indigo violet
- 4765 marrone glacé glacé brown
- 0408 grigio antracite charcoal grey
- 0802 nero assoluto absolute black

seduta - seat
ecopelle - artificial leather

- 102 bianco zucchero sugar white
- 118 beige tortora taupe beige
- 113 grigio fango taupe grey
- 129 rosso scarlatto scarlet red
- 110 marrone caffè coffee brown
- 126 grigio silver silver grey
- 120 grigio antracite charcoal grey
- 101 nero assoluto absolute black

seduta - seat
ecopelle - artificial leather

- 004 marrone noce walnut brown
- 007 marrone glacé glacé brown
- 002 grigio antracite charcoal grey
- 001 nero assoluto absolute black

seduta - seat
ecopelle - artificial leather

- 79 giallo senape mustard yellow
- 29 rosso rubino ruby red
- 60 verde menta mint green
- 15 grigio perla pearl grey
- 44 grigio antracite charcoal grey
- 13 nero assoluto absolute black



Sedia Rapper con struttura in tondino di acciaio verniciato, colore nero assoluto e seduta in polipropilene soft touch, nello stesso colore.
Rapper chair with painted steel rod frame, absolute black colour and soft touch polypropylene seat, in the same colour.

Sedie Rapper con struttura in tondino di acciaio verniciato, colore nero assoluto e seduta in polipropilene soft touch rivestita in ecopelle, Econabuk, colore grigio perla. ft. sedia Rap.w, tavolo Star.

Rapper chairs with painted steel frame, absolute black colour and soft touch polypropylene seat upholstered with artificial leather, Econabuk, pearl grey colour. ft. Rap.w chair, Star table.



Rapper.ss

Design F. di Martino

Sgabello con struttura in tondino di acciaio verniciato e seduta realizzata in polipropilene soft touch, materiale riciclabile e disponibile in diversi colori. La seduta può essere rivestita in tessuto o ecopelle.

Stool with painted steel rod frame and seat made of soft touch polypropylene, recyclable material available in different colours. The seat can be upholstered with fabric or artificial leather.

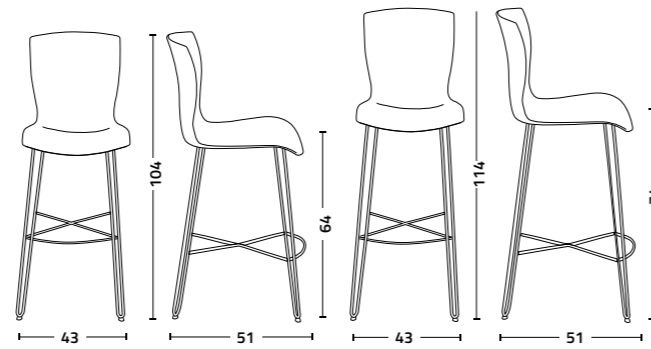

struttura - frame
tondino di acciaio - steel rod

- 9003 bianco zucchero sugar white
- 9005 nero assoluto absolute black

seduta - seat
polipropilene polypropylene

- 9003 bianco zucchero sugar white
- 1019 beige tortora taupe beige
- 7024 grigio antracite charcoal grey
- 9005 nero assoluto absolute black

seduta - seat
tessuto - fabric
vivido

- 03 grigio tortora taupe grey
- 59 rosa pastello pastel pink
- 57 rosso borgogna burgundy red
- 42 verde marino marine green
- 05 grigio antracite charcoal grey
- 32 nero assoluto absolute black

seduta - seat
tessuto - fabric
magico

- 01 bianco avorio ivory white
- 11 giallo senape mustard yellow
- 03 beige avana fallow beige
- 02 beige canapa hemp beige
- 04 marrone glacé glacé brown
- 05 grigio silver silver grey
- 06 grigio ardesia slate grey

seduta - seat
tessuto - fabric
fiocco

- 0206 beige canapa hemp beige
- 8008 rosa corallo coral pink
- 9260 arancione ruggine rust orange
- 3103 rosso scarlatto scarlet red
- 6714 verde mirto brunswick green
- 5667 verde ottanio teal green
- 5554 viola indaco indigo violet
- 4765 marrone glacé glacé brown
- 0408 grigio antracite charcoal grey
- 0802 nero assoluto absolute black

seduta - seat
ecopelle - artificial leather
magnum

- 102 bianco zucchero sugar white
- 118 beige tortora taupe beige
- 113 grigio fango taupe grey
- 129 rosso scarlatto scarlet red
- 110 marrone caffè coffee brown
- 126 grigio silver silver grey
- 120 grigio antracite charcoal grey
- 101 nero assoluto absolute black

seduta - seat
ecopelle - artificial leather
vintage

- 004 marrone noce walnut brown
- 007 marrone glacé glacé brown
- 002 grigio antracite charcoal grey
- 001 nero assoluto absolute black

seduta - seat
ecopelle - artificial leather
econabuk

- 79 giallo senape mustard yellow
- 29 rosso rubino ruby red
- 60 verde menta mint green
- 15 grigio perla pearl grey
- 44 grigio antracite charcoal grey
- 13 nero assoluto absolute black



Nelle due altezze disponibili, sgabello Rapper.ss con struttura in tondino di acciaio verniciato, colore bianco zucchero e seduta in polipropilene soft touch, nello stesso colore.
In its two available heights, Rapper.ss stool with painted steel rod frame, sugar white colour and soft touch polypropylene seat, in the same colour.



Sgabello Rapper.ss con struttura in tondino di acciaio verniciato, colore nero assoluto e seduta in polipropilene soft touch rivestita in ecopelle, Econabuk, colore grigio perla.



Rapper.ss stool with painted steel frame, absolute black colour and soft touch polypropylene seat upholstered with ecological artificial leather, Econabuk, pearl grey colour.

Rap.w

Design F. di Martino

Sedia con struttura in legno di rovere naturale o laccato e seduta realizzata in polipropilene soft touch, materiale riciclabile e disponibile in diversi colori. La seduta può essere rivestita in tessuto o ecopelle.

Chair with natural or lacquered oak wood frame and seat made of soft touch polypropylene, recyclable material available in different colours. The seat can be upholstered with fabric or artificial leather.

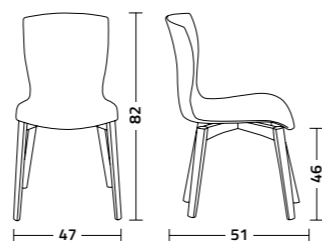

struttura - frame rovere - oak

- 0001 naturale natural
- 0002 smoke smoke
- 9005 nero assoluto absolute black

seduta - seat polipropilene - polypropylene

- 9003 bianco zucchero sugar white
- 1019 beige tortora taupe beige
- 7024 grigio antracite charcoal grey
- 9005 nero assoluto absolute black

seduta - seat tessuto - fabric vivido

- 03 grigio tortora taupe grey
- 59 rosa pastello pastel pink
- 57 rosso borgogna burgundy red
- 42 verde marino marine green
- 05 grigio antracite charcoal grey
- 32 nero assoluto absolute black

seduta - seat tessuto - fabric magico

- 01 bianco avorio ivory white
- 11 giallo senape mustard yellow
- 03 beige avana fallow beige
- 02 beige canapa hemp beige
- 04 marrone glacé glacé brown
- 05 grigio silver silver grey
- 06 grigio ardesia slate grey

seduta - seat tessuto - fabric fiocco

- 0206 beige canapa hemp beige
- 8008 rosa corallo coral pink
- 9260 arancione ruggine rust orange
- 3103 rosso scarlatto scarlet red
- 6714 verde mirto brunswick green
- 5667 verde ottanio teal green
- 5554 viola indaco indigo violet
- 4765 marrone glacé glacé brown
- 0408 grigio antracite charcoal grey
- 0802 nero assoluto absolute black

seduta - seat ecopelle - artificial leather magnum

- 102 bianco zucchero sugar white
- 118 beige tortora taupe beige
- 113 grigio fango taupe grey
- 129 rosso scarlatto scarlet red
- 110 marrone caffè coffee brown
- 126 grigio silver silver grey
- 120 grigio antracite charcoal grey
- 101 nero assoluto absolute black

seduta - seat ecopelle - artificial leather vintage

- 004 marrone noce walnut brown
- 007 marrone glacé glacé brown
- 002 grigio antracite charcoal grey
- 001 nero assoluto absolute black

seduta - seat ecopelle - artificial leather econabuk

- 79 giallo senape mustard yellow
- 29 rosso rubino ruby red
- 60 verde menta mint green
- 15 grigio perla pearl grey
- 44 grigio antracite charcoal grey
- 13 nero assoluto absolute black



Sedia Rap.w con struttura in legno di rovere naturale e seduta in polipropilene soft touch, colore bianco zucchero.

Rap.w chair with natural oak wood frame and soft touch polypropylene, sugar white colour.

Sedia Rap.w con struttura in legno di rovere laccato, colore nero assoluto e seduta in polipropilene soft touch rivestita in ecopelle, Econabuk, colore nero assoluto.
Rap.w chair with lacquered oak wood frame, absolute black colour and soft touch polypropylene seat upholstered with artificial leather, Econabuk, absolute black colour.



Sedia Rap.w con struttura in legno di rovere laccato, colore nero assoluto e seduta in polipropilene soft touch rivestita in ecopelle, Econabuk, colore grigio perla.
Rap.w chair with lacquered oak wood frame, absolute black colour and soft touch polypropylene seat upholstered with artificial leather, Econabuk, pearl grey colour.

Rap Wood

Design F. di Martino

Sedia con struttura in legno di rovere naturale o laccato ed intreccio in acciaio verniciato; seduta realizzata in polipropilene soft touch, materiale riciclabile e disponibile in diversi colori. La seduta può essere rivestita in tessuto o ecopelle.

Chair with natural or lacquered oak wood frame and painted steel crossing; seat made of soft touch polypropylene, recyclable material available in different colours. The seat can be upholstered with fabric or artificial leather.

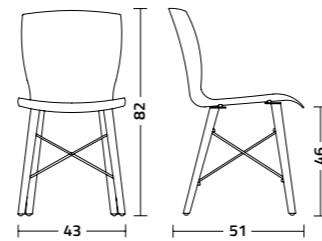

struttura - frame
rovere - oak

- 0001 naturale natural
- 0002 smoke smoke
- 9005 nero assoluto absolute black

intreccio - crossing
acciaio - steel

- 9003 bianco zucchero sugar white
- 1019 beige tortora taupe beige
- 7024 grigio antracite charcoal grey
- 9005 nero assoluto absolute black

seduta - seat
polipropilene - polypropylene

- 9003 bianco zucchero sugar white
- 1019 beige tortora taupe beige
- 7024 grigio antracite charcoal grey
- 9005 nero assoluto absolute black

seduta - seat
tessuto - fabric
vivido

- 03 grigio tortora taupe grey
- 59 rosa pastello pastel pink
- 57 rosso borgogna burgundy red
- 42 verde marino marine green
- 05 grigio antracite charcoal grey
- 32 nero assoluto absolute black

seduta - seat
tessuto - fabric
magico

- 01 bianco avorio ivory white
- 11 giallo senape mustard yellow
- 03 beige avana fallow beige
- 02 beige canapa hemp beige
- 04 marrone glacé glacé brown
- 05 grigio silver silver grey
- 06 grigio ardesia slate grey

seduta - seat
tessuto - fabric
fiocco

- 0206 beige canapa hemp beige
- 8008 rosa corallo coral pink
- 9260 arancione ruggine rust orange
- 3103 rosso scarlatto scarlet red
- 6714 verde mirto brunswick green
- 5667 verde ottanio teal green
- 5554 viola indaco indigo violet
- 4765 marrone glacé glacé brown
- 0408 grigio antracite charcoal grey
- 0802 nero assoluto absolute black

seduta - seat
ecopelle - artificial leather
magnum

- 102 bianco zucchero sugar white
- 118 beige tortora taupe beige
- 113 grigio fango taupe grey
- 129 rosso scarlatto scarlet red
- 110 marrone caffè coffee brown
- 126 grigio silver silver grey
- 120 grigio antracite charcoal grey
- 101 nero assoluto absolute black

seduta - seat
ecopelle - artificial leather
vintage

- 004 marrone noce walnut brown
- 007 marrone glacé glacé brown
- 002 grigio antracite charcoal grey
- 001 nero assoluto absolute black

seduta - seat
ecopelle - artificial leather
econabuk

- 79 giallo senape mustard yellow
- 29 rosso rubino ruby red
- 60 verde menta mint green
- 15 grigio perla pearl grey
- 44 grigio antracite charcoal grey
- 13 nero assoluto absolute black



Sedia Rap Wood con struttura in legno di rovere naturale; intreccio in acciaio verniciato, colore bianco zucchero e seduta in polipropilene soft touch, nello stesso colore. ft. tavolo Slash.

Rap Wood chair with natural oak wood frame; painted steel crossing, sugar white colour and soft touch polypropylene seat, in the same colour. ft. Slash table.





Sedia Rap Wood con struttura in legno di rovere naturale ed intreccio in acciaio verniciato, colore nero assoluto e seduta in polipropilene soft touch rivestita in ecopelle, Econabuk, colore nero assoluto.
Rap Wood chair with natural oak wood frame and painted steel crossing, absolute black colour and soft touch polypropylene seat upholstered with artificial leather, Econabuk, absolute black colour.

Collezione sedie e sgabelli Rap Wood; esempi colore.
Rap Wood chairs and stools collection; colour examples.



Rap Wood.ss

Design F. di Martino

Sgabello con struttura in legno di rovere naturale o laccato ed intreccio in acciaio verniciato; seduta realizzata in polipropilene soft touch, materiale riciclabile e disponibile in diversi colori. La seduta può essere rivestita in tessuto o ecopelle.

Stool with natural or lacquered oak wood frame and painted steel crossing; seat made of soft touch polypropylene, recyclable material available in different colours. The seat can be upholstered with fabric or artificial leather.

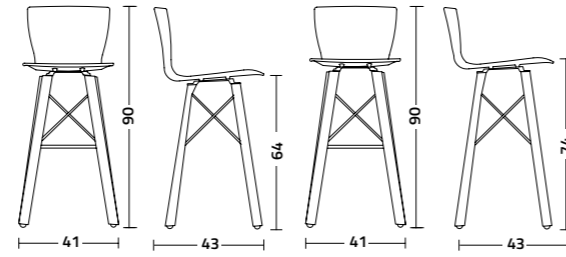

struttura - frame
rovere - oak

- 0001 naturale natural
- 0002 smoke smoke
- 9005 nero assoluto absolute black

intreccio - crossing
acciaio - steel

- 9003 bianco zucchero sugar white
- 1019 beige tortora taupe beige
- 7024 grigio antracite charcoal grey
- 9005 nero assoluto absolute black

seduta - seat
polipropilene - polypropylene

- 9003 bianco zucchero sugar white
- 1019 beige tortora taupe beige
- 7024 grigio antracite charcoal grey
- 9005 nero assoluto absolute black

seduta - seat
tessuto - fabric
vivido

- 03 grigio tortora taupe grey
- 59 rosa pastello pastel pink
- 57 rosso borgogna burgundy red
- 42 verde marino marine green
- 05 grigio antracite charcoal grey
- 32 nero assoluto absolute black

seduta - seat
tessuto - fabric
magico

- 01 bianco avorio ivory white
- 11 giallo senape mustard yellow
- 03 beige avana fallow beige
- 02 beige canapa hemp beige
- 04 marrone glacé glacé brown
- 05 grigio silver silver grey
- 06 grigio ardesia slate grey

seduta - seat
tessuto - fabric
fiocco

- 0206 beige canapa hemp beige
- 8008 rosa corallo coral pink
- 9260 arancione ruggine rust orange
- 3103 rosso scarlatto scarlet red
- 6714 verde mirto brunswick green
- 5667 verde ottanio teal green
- 5554 viola indaco indigo violet
- 4765 marrone glacé glacé brown
- 0408 grigio antracite charcoal grey
- 0802 nero assoluto absolute black

seduta - seat
ecopelle - artificial leather
magnum

- 102 bianco zucchero sugar white
- 118 beige tortora taupe beige
- 113 grigio fango taupe grey
- 129 rosso scarlatto scarlet red
- 110 marrone caffè coffee brown
- 126 grigio silver silver grey
- 120 grigio antracite charcoal grey
- 101 nero assoluto absolute black

seduta - seat
ecopelle - artificial leather
vintage

- 004 marrone noce walnut brown
- 007 marrone glacé glacé brown
- 002 grigio antracite charcoal grey
- 001 nero assoluto absolute black

seduta - seat
ecopelle - artificial leather
econabuk

- 79 giallo senape mustard yellow
- 29 rosso rubino ruby red
- 60 verde menta mint green
- 15 grigio perla pearl grey
- 44 grigio antracite charcoal grey
- 13 nero assoluto absolute black



Sgabello Rap Wood.ss con struttura in legno di rovere laccato, colore smoke; intreccio in acciaio verniciato, colore nero assoluto e seduta in polipropilene soft touch, nello stesso colore.
Rap Wood stool with lacquered oak wood frame, smoke colour; painted steel crossing, absolute black colour and soft touch polypropylene seat, in the same colour.

Cuisine



Jack_JackJr

Design F. di Martino

Sgabelli con struttura in legno di rovere naturale o laccato ed intreccio in acciaio verniciato; seduta realizzata in sughero naturale o smoke.

Stools with natural or lacquered oak wood frame and painted steel crossing; seat made of natural or smoke cork.

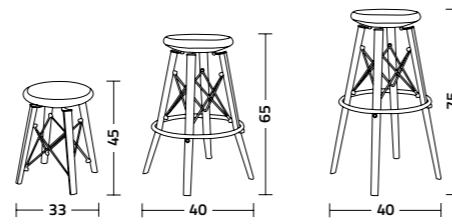

struttura - frame
rovere - oak

- 0001 naturale
natural
- 0002 smoke
smoke
- 9005 nero assoluto
absolute black

intreccio - crossing
acciaio - steel

- 9003 bianco zucchero
sugar white
- 9005 nero assoluto
absolute black

seduta - seat
sughero - cork

- 0001 naturale
natural
- 0002 smoke
smoke



Sgabelli Jack con struttura in legno di rovere laccato, colore smoke; intreccio in acciaio verniciato, colore nero assoluto e seduta in sughero smoke.

Jack stools with lacquered oak wood frame, smoke colour; painted steel crossing, absolute black colour and smoke cork seat.





Dettaglio e scatto, sgabelli Jack e Jack Jr con struttura in legno di rovere naturale; intreccio in acciaio verniciato, colore bianco zucchero e seduta in sughero naturale.

Detail and shoot, Jack and Jack Jr stools with natural oak wood frame; painted steel crossing, sugar white colour and natural cork seat.



Hip

Design F. di Martino

Sedia impilabile con struttura in acciaio cromato o verniciato e seduta realizzata in metacrilato.

Stackable chair with painted or chrome-plated steel frame and seat made of methacrylate.

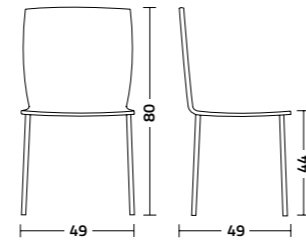

struttura - frame
acciaio - steel

- 9003 bianco zucchero
sugar white
- 7032 beige champagne
champagne beige
- 7022 grigio piombo
lead grey
- 9005 nero assoluto
absolute black
- 0070 cromo
chrome

seduta - seat
metacrilato - methacrylate

- 0001 trasparente
transparent
- 0055 erba palustre
marsh grass



Sedia Hip con struttura in acciaio cromato e seduta in metacrilato, finitura trasparente insieme a sgabello Hip.ss con base in alluminio e struttura con pistone in acciaio cromato; seduta in metacrilato, finitura trasparente.

Hip chair with chrome-plated steel frame and methacrylate seat, transparent finish together with Hip.ss stool with chrome-plated aluminium and steel frame and piston; methacrylate seat, transparent finish.





Dettaglio e scatto frontale, sedia Hip con struttura in acciaio verniciato, colore beige champagne e seduta in metacrilato, finitura erba palustre.
Detail and front shoot, Hip chair with painted steel frame, champagne beige colour and methacrylate seat, marsh grass finish.

Hip.ss

Design F. di Martino

Sgabello con base in alluminio verniciato o cromato; la struttura, girevole e regolabile in altezza tramite pistone a gas, è in acciaio verniciato o cromato. La seduta, realizzata in metacrilato, può essere rivestita in cuoio.

Stool with painted or chrome-plated aluminium base; the frame, swiveling and height-adjustable through a gas piston, is in painted or chrome-plated steel and the seat is in methacrylate.

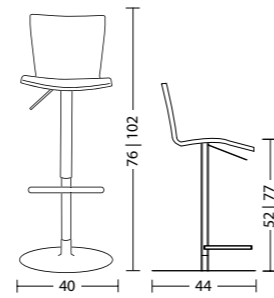

base - base
alluminio - aluminium
struttura - frame
acciaio - steel

- 9003 bianco zucchero
sugar white
- 7032 beige champagne
champagne beige
- 7022 grigio piombo
lead grey
- 9005 nero assoluto
charcoal black
- 0070 cromo
chrome

seduta - seat
metacrilato - methacrylate

- 0001 trasparente
transparent
- 0055 erba palustre
marsh grass

seduta - seat
cuoio - leather
cuoietto

- 102 bianco latte
milk white
- 116 marrone glacé
glacé brown
- 110 marrone caffè
coffee brown
- 120 grigio antracite
charcoal grey
- 101 nero assoluto
absolute black



Sgabello Hip.ss con base in alluminio e struttura in acciaio verniciato, colore beige champagne e pistone in acciaio cromato; seduta in metacrilato, finitura erba palustre.

Hip.ss stool with painted aluminium and steel frame, champagne beige colour and chrome-plated steel piston; methacrylate seat, marsh grass finish.

Da sinistra, sgabello Hip.ss con base in alluminio e struttura con pistone in acciaio cromato; seduta in metacrilato, finitura trasparente.
Sgabello Hip.ss con base in alluminio e struttura in acciaio verniciato, colore beige champagne e pistone in acciaio cromato; seduta in metacrilato, finitura erba palustre.

Sgabello Hip.ss con base in alluminio e struttura in acciaio verniciato, colore grigio piombo e pistone in acciaio cromato; seduta in metacrilato, finitura trasparente.
From the left, Hip.ss stool with chrome-plated aluminium and steel frame and piston; methacrylate seat, transparent finish.
Hip.ss stool with painted aluminium and steel frame, champagne beige colour and chrome-plated steel piston; methacrylate seat, marsh grass finish. Hip.ss stool with painted aluminium and steel frame, lead grey colour and chrome-plated steel piston; methacrylate seat, transparent finish.



Dettaglio, sgabello Hip.ss con base in alluminio e struttura in acciaio verniciato, colore beige champagne e pistone in acciaio cromato; seduta in metacrilato, finitura erba palustre.
Detail, Hip.ss stool with painted aluminium and steel frame, champagne beige colour and chrome-plated steel piston; methacrylate seat, marsh grass finish.



Dettaglio, sgabello Hip.ss con seduta rivestita cuoio, Cuoietto, colore nero assoluto.
Detail, seat Hip.ss stool upholstered with leather, Cuoietto, absolute black colour.

Joker

Design F. di Martino

Sgabello con base in alluminio verniciato o cromato; la struttura, girevole e regolabile in altezza tramite pistone a gas, è in acciaio verniciato o cromato. La seduta, realizzata in metacrilato, può essere rivestita in cuoio.

Stool with painted or chrome-plated aluminium base; the frame, swiveling and height-adjustable through a gas piston, is in painted or chrome-plated steel and the seat is in methacrylate.

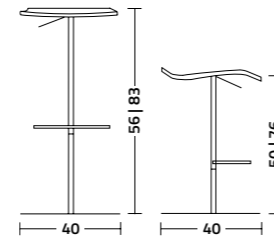

base - base
alluminio - aluminium
struttura - frame
acciaio - steel

- 9003 bianco zucchero
sugar white
- 7032 beige champagne
champagne beige
- 7022 grigio piombo
lead grey
- 9005 nero assoluto
absolute black
- 0070 cromo
chrome

seduta - seat
metacrilato - methacrylate

- 0001 trasparente
transparent

seduta - seat
cuoio - leather
cuoietto

- 102 bianco latte
milk white
- 116 marrone glacé
glacé brown
- 110 marrone caffè
coffee brown
- 120 grigio antracite
charcoal grey
- 101 nero assoluto
absolute black



Sgabello Joker con base in alluminio e struttura in acciaio verniciato, colore beige champagne e pistone in acciaio cromato; seduta in metacrilato, finitura trasparente.

Joker stool with painted aluminium and steel frame, champagne beige colour and chrome-plated steel piston; methacrylate seat, transparent finish.

Dettaglio e scatto, sgabello Joker con base in alluminio e struttura in acciaio verniciato, colore grigio antracite e pistone in acciaio cromato; seduta in metacrilato, rivestita in cuoio, Cuoietto, colore grigio antracite con cuciture in contrasto, colore verde acquamarina.

Detail and shoot, Joker stool with painted aluminium and steel frame, charcoal grey colour and chrome-plated steel piston; methacrylate seat, upholstered with leather, Cuoietto, charcoal grey colour with contrasting stitching, aquamarine green colour.



Bip

Design W&D

Sedia impilabile con struttura in acciaio cromato o verniciato; la seduta, realizzata in tecnopolimero composito riciclabile, può essere rivestita in tessuto o ecopelle.

Stackable chair with painted or chrome-plated steel frame; its seat, made of recyclable composite technopolymer, can be upholstered with fabric or artificial leather.

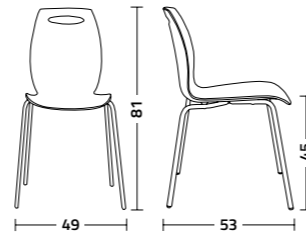

struttura - frame acciaio - steel

- 9003 bianco zucchero sugar white
- 7032 beige champagne champagne beige
- 7022 grigio piombo lead grey
- 9005 nero assoluto absolute black
- 0070 cromo chrome
- 0076 cromo ottone brass chrome

seduta - seat tecnopolimero composito composite technopolymer

- 9003 bianco zucchero sugar white
- 5014 azzurro avio steel blue

seduta - seat tessuto - fabric vivido

- 03 grigio tortora taupe grey
- 59 rosa pastello pastel pink
- 57 rosso borgogna burgundy red
- 42 verde marino marine green
- 05 grigio antracite charcoal grey
- 32 nero assoluto absolute black

seduta - seat tessuto - fabric magico

- 01 bianco avorio ivory white
- 11 giallo senape mustard yellow
- 03 beige avana fallow beige
- 02 beige canapa hemp beige
- 04 marrone glacé glacé brown
- 05 grigio silver silver grey
- 06 grigio ardesia slate grey

seduta - seat tessuto - fabric fiocco

- 0206 beige canapa hemp beige
- 8008 rosa corallo coral pink
- 9260 arancione ruggine rust orange
- 3103 rosso scarlatto scarlet red
- 6714 verde mirto brunswick green
- 5667 verde ottanio teal green
- 5554 viola indaco indigo violet
- 4765 marrone glacé glacé brown
- 0408 grigio antracite charcoal grey
- 0802 nero assoluto absolute black

seduta - seat ecopelle - artificial leather magnum

- 102 bianco zucchero sugar white
- 118 beige tortora taupe beige
- 113 grigio fango taupe grey
- 129 rosso scarlatto scarlet red
- 110 marrone caffè coffee brown
- 126 grigio silver silver grey
- 120 grigio antracite charcoal grey
- 101 nero assoluto absolute black

seduta - seat ecopelle - artificial leather vintage

- 004 marrone noce walnut brown
- 007 marrone glacé glacé brown
- 002 grigio antracite charcoal grey
- 001 nero assoluto absolute black

seduta - seat ecopelle - artificial leather econabuk

- 79 giallo senape mustard yellow
- 29 rosso rubino ruby red
- 60 verde menta mint green
- 15 grigio perla pearl grey
- 44 grigio antracite charcoal grey
- 13 nero assoluto absolute black



In primo piano:
sedia Bip con struttura in acciaio cromato, colore ottone e seduta in tecnopolimero composito rivestita in ecopelle, Econabuk, colore grigio perla.
Sullo sfondo:
sedia Bip con struttura in acciaio verniciato, colore beige champagne e seduta in tecnopolimero composito rivestita in ecopelle, Econabuk, colore grigio perla.

On the foreground:
Bip chair with chrome-plated steel frame, brass colour and composite technopolymer seat upholstered with artificial leather, Econabuk, pearl grey colour.
On the background:
Bip chair with painted steel frame, champagne beige colour and composite technopolymer seat upholstered with artificial leather, Econabuk, pearl grey colour.



Sedie Bip con struttura in acciaio cromato, colore ottone e seduta in tecnopolimero composito, colore azzurro avio.
ft. tavolo Star.

Bip chairs with chrome-plated steel frame, brass colour and composite technopolymer seat, steel blue colour.
ft. Star table.





Sedia Bip con struttura in acciaio verniciato, colore beige champagne e seduta in tecnopolimero composito rivestita in tessuto, Vivido, colore rosa pastello.
Bip chair with painted steel frame, champagne beige colour and composite technopolymer seat upholstered with fabric, Vivido, pastel rose colour.



Bip.ss

Design W&D

Sgabello con base in alluminio verniciato o cromato; la struttura, girevole e regolabile in altezza tramite pistone a gas, è realizzata in acciaio verniciato o cromato; la seduta, realizzata in tecnopolimero composito riciclabile, può essere rivestita in tessuto o ecopelle.

Stool with painted or chrome-plated aluminium base; the frame, swiveling and height-adjustable through a gas piston, is made of painted or chrome-plated steel; the seat, made of recyclable composite technopolymer, can be upholstered with fabric or artificial leather.

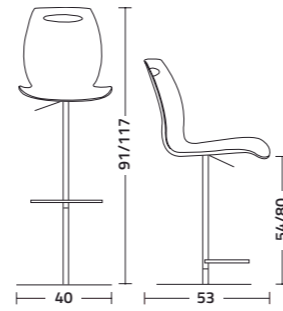

base - base
alluminio - aluminium
struttura - frame
acciaio - steel

- 9003 bianco zucchero
sugar white
- 7032 beige champagne
champagne beige
- 7022 grigio piombo
lead grey
- 9005 nero assoluto
absolute black
- 0070 cromo
chrome

seduta - seat
tecnopolimero composito
composite technopolymer

- 9003 bianco zucchero
sugar white
- 5014 azzurro avio
steel blue

seduta - seat
tessuto - fabric
vivido

- 03 grigio tortora
taupe grey
- 59 rosa pastello
pastel pink
- 57 rosso borgogna
burgundy red
- 42 verde marino
marine green
- 05 grigio antracite
charcoal grey
- 32 nero assoluto
absolute black

seduta - seat
tessuto - fabric
magico

- 01 bianco avorio
ivory white
- 11 giallo senape
mustard yellow
- 03 beige avana
fallow beige
- 02 beige canapa
hemp beige
- 04 marrone glacé
glacé brown
- 05 grigio silver
silver grey
- 06 grigio ardesia
slate grey

seduta - seat
tessuto - fabric
fiocco

- 0206 beige canapa
hemp beige
- 8008 rosa corallo
coral pink
- 9260 arancione ruggine
rust orange
- 3103 rosso scarlatto
scarlet red
- 6714 verde mirto
brunswick green
- 5667 verde ottanio
teal green
- 5554 viola indaco
indigo violet
- 4765 marrone glacé
glacé brown
- 0408 grigio antracite
charcoal grey
- 0802 nero assoluto
absolute black

seduta - seat
ecopelle - artificial leather
magnum

- 102 bianco zucchero
sugar white
- 118 beige tortora
taupe beige
- 113 grigio fango
taupe grey
- 129 rosso scarlatto
scarlet red
- 110 marrone caffè
coffee brown
- 126 grigio silver
silver grey
- 120 grigio antracite
charcoal grey
- 101 nero assoluto
absolute black

seduta - seat
ecopelle - artificial leather
vintage

- 004 marrone noce
walnut brown
- 007 marrone glacé
glacé brown
- 002 grigio antracite
charcoal grey
- 001 nero assoluto
absolute black

seduta - seat
ecopelle - artificial leather
econabuk

- 79 giallo senape
mustard yellow
- 29 rosso rubino
ruby red
- 60 verde menta
mint green
- 15 grigio perla
pearl grey
- 44 grigio antracite
charcoal grey
- 13 nero assoluto
absolute black



A sinistra,
Sgabello Bip.ss con base in alluminio,
struttura e pistone in acciaio verniciato,
colore nero assoluto; seduta in tecnopolimero
composito rivestita in ecopelle, Econabuk,
colore grigio perla.

A destra,
Sgabello Bip.ss con base in alluminio e struttura
in acciaio verniciato, colore beige champagne
e pistone in acciaio cromato; seduta in
tecnopolimero composito rivestita in ecopelle,
Econabuk, colore grigio perla.

On the left,
Bip.ss stool with painted aluminium base,
steel frame and piston, absolute black colour;
composite technopolymer seat upholstered
with artificial leather,
Econabuk, pearl grey colour.

On the right,
Bip.ss stool with painted aluminium base
and steel frame, champagne beige colour
and chrome-plated steel piston; composite
technopolymer seat upholstered with artificial
leather, Econabuk, pearl grey colour.



Sgabello Bip.ss con base in alluminio, struttura e pistone in acciaio cromato; seduta in tecnopolimero composito, colore bianco zucchero.

Bip.ss stool with chrome-plated aluminium base, steel frame and piston; composite technopolymer seat, sugar white colour.



Sgabello Bip.ss con base in alluminio, struttura e pistone in acciaio verniciato, colore bianco zucchero; seduta in tecnopolimero composito, nello stesso colore.

Bip.ss stool with painted aluminium base, steel frame and piston, sugar white colour; composite technopolymer seat, in the same colour.

Bip Iron

Design W&D

Sedia con struttura in tondino di acciaio verniciato; la seduta, realizzata in tecnopolimero composito riciclabile, può essere rivestita in tessuto o ecopelle.

Chair with painted steel rod frame; its seat, made of recyclable composite technopolymer, can be upholstered with fabric or artificial leather.

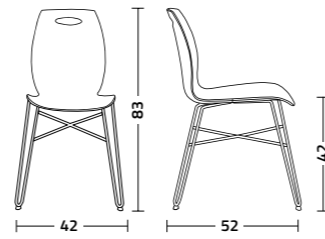

struttura - frame
tondino di acciaio
steel rod

- 9003 bianco zucchero
sugar white
- 9005 nero assoluto
absolute black

seduta - seat
tecnopolimero composito
composite technopolymer

- 9003 bianco zucchero
sugar white
- 5014 azzurro avio
steel blue

seduta - seat
tessuto - fabric
vivido

- 03 grigio tortora
taupe grey
- 59 rosa pastello
pastel pink
- 57 rosso borgogna
burgundy red
- 42 verde marino
marine green
- 05 grigio antracite
charcoal grey
- 32 nero assoluto
absolute black

seduta - seat
tessuto - fabric
magico

- 01 bianco avorio
ivory white
- 11 giallo senape
mustard yellow
- 03 beige avana
fallow beige
- 02 beige canapa
hemp beige
- 04 marrone glacé
glacé brown
- 05 grigio silver
silver grey
- 06 grigio ardesia
slate grey

seduta - seat
tessuto - fabric
fiocco

- 0206 beige canapa
hemp beige
- 8008 rosa corallo
coral pink
- 9260 arancione ruggine
rust orange
- 3103 rosso scarlatto
scarlet red
- 6714 verde mirto
brunswick green
- 5667 verde ottanio
teal green
- 5554 viola indaco
indigo violet
- 4765 marrone glacé
glacé brown
- 0408 grigio antracite
charcoal grey
- 0802 nero assoluto
absolute black

seduta - seat
ecopelle - artificial leather
magnum

- 102 bianco zucchero
sugar white
- 118 beige tortora
taupe beige
- 113 grigio fango
taupe grey
- 129 rosso scarlatto
scarlet red
- 110 marrone caffè
coffee brown
- 126 grigio silver
silver grey
- 120 grigio antracite
charcoal grey
- 101 nero assoluto
absolute black

seduta - seat
ecopelle - artificial leather
vinatge

- 004 marrone noce
walnut brown
- 007 marrone glacé
glacé brown
- 002 grigio antracite
charcoal grey
- 001 nero assoluto
absolute black

seduta - seat
ecopelle - artificial leather
econabuk

- 79 giallo senape
mustard yellow
- 29 rosso rubino
ruby red
- 60 verde menta
mint green
- 15 grigio perla
pearl grey
- 44 grigio antracite
charcoal grey
- 13 nero assoluto
absolute black



Sedia Bip Iron con base in tondino di acciaio verniciato, colore bianco zucchero e seduta in tecnopolimero composito, nello stesso colore.
Bip Iron chair with painted steel frame, sugar white colour and composite technopolymer seat, in the same colour.



Bip Iron.ss

Design W&D

Sgabello con struttura in tondino di acciaio verniciato; la seduta, realizzata in tecnopolimero composito riciclabile, può essere rivestita in tessuto o ecopelle.

Stool with painted steel rod frame; its seat, made of recyclable composite technopolymer, can be upholstered with fabric or artificial leather.

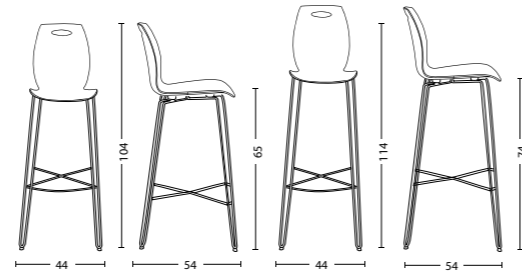

struttura - frame
tondino di acciaio
steel rod

- 9003 bianco zucchero
sugar white
- 9005 nero assoluto
absolute black

seduta - seat
tecnopolimero composito
composite technopolymer

- 9003 bianco zucchero
sugar white
- 5014 azzurro avio
steel blue

seduta - seat
tessuto - fabric
vivido

- 03 grigio tortora
taupe grey
- 59 rosa pastello
pastel pink
- 57 rosso borgogna
burgundy red
- 42 verde marino
marine green
- 05 grigio antracite
charcoal grey
- 32 nero assoluto
absolute black

seduta - seat
tessuto - fabric
magico

- 01 bianco avorio
ivory white
- 11 giallo senape
mustard yellow
- 03 beige avana
fallow beige
- 02 beige canapa
hemp beige
- 04 marrone glacé
glacé brown
- 05 grigio silver
silver grey
- 06 grigio ardesia
slate grey

seduta - seat
tessuto - fabric
fiocco

- 0206 beige canapa
hemp beige
- 8008 rosa corallo
coral pink
- 9260 arancione ruggine
rust orange
- 3103 rosso scarlatto
scarlet red
- 6714 verde mirto
brunswick green
- 5667 verde ottanio
teal green
- 5554 viola indaco
indigo violet
- 4765 marrone glacé
glacé brown
- 0408 grigio antracite
charcoal grey
- 0802 nero assoluto
absolute black

seduta - seat
ecopelle - artificial leather
magnum

- 102 bianco zucchero
sugar white
- 118 beige tortora
taupe beige
- 113 grigio fango
taupe grey
- 129 rosso scarlatto
scarlet red
- 110 marrone caffè
coffee brown
- 126 grigio silver
silver grey
- 120 grigio antracite
charcoal grey
- 101 nero assoluto
absolute black

seduta - seat
ecopelle - artificial leather
vintage

- 004 marrone noce
walnut brown
- 007 marrone glacé
glacé brown
- 002 grigio antracite
charcoal grey
- 001 nero assoluto
absolute black

seduta - seat
ecopelle - artificial leather
econabuk

- 79 giallo senape
mustard yellow
- 29 rosso rubino
ruby red
- 60 verde menta
mint green
- 15 grigio perla
pearl grey
- 44 grigio antracite
charcoal grey
- 13 nero assoluto
absolute black

Sedia Bip Iron e sgabello Bip Iron.ss con base in tondino di acciaio verniciato, colore nero assoluto e seduta in tecnopolimero composito rivestita in ecopelle, Econabuk, colore grigio perla.

Bip Iron chair and Bip Iron stool with painted steel frame, absolute black colour and composite technopolymer seat upholstered with artificial leather, Econabuk, pearl grey colour.



Brera

Design W. Colico

Sedia in legno di faggio laccato, disponibile in un'ampia gamma colori.
Chair in lacquered beech wood, available in a wide range of colours.

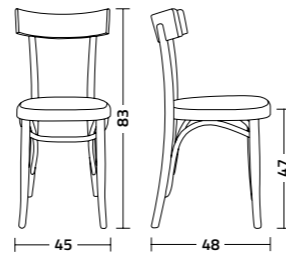

struttura - frame
faggio - beech

- 9003 bianco zucchero
sugar white
- 7044 beige avana
sand beige
- 1016 giallo limone
lemon yellow
- 2011 arancione mandarino
tangerine orange
- 3031 rosso ciliegia
cherry red
- 4006 viola porpora
purple violet
- 5015 azzurro cielo
sky blue
- 5002 blu oltremare
ultramarine blue
- 0030 verde mela
apple green
- 7045 grigio silver
silver grey
- 9005 nero assoluto
absolute black



Nella pagina accanto:
Sedia Brera in legno di faggio laccato,
colore blu oltremare.

On the opposite page:
Brera chair in lacquered beech wood,
ultramarine blue colour.

Sedia Brera in legno di faggio laccato, gamma colori.
ft. tavolo Slash.
Brera chair in lacquered beech wood, colour range.
ft. Slash table.



Brera.ss

Design W. Colico

Sgabello in legno di faggio laccato, disponibile in un'ampia gamma colori.

Stool in lacquered beech wood, available in a wide range of colours.

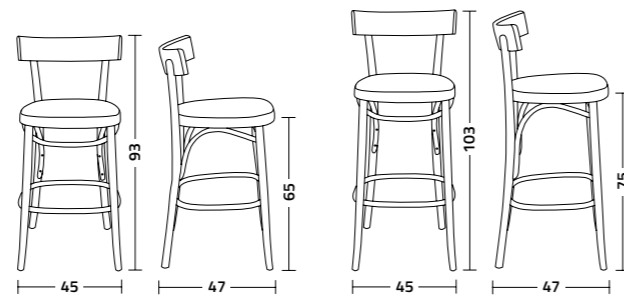

struttura - frame faggio - beech

- 9003 bianco zucchero
sugar white
- 7044 beige avana
sand beige
- 1016 giallo limone
lemon yellow
- 2011 arancione mandarino
tangerine orange
- 3031 rosso ciliegia
cherry red
- 4006 viola porpora
purple violet
- 5015 azzurro cielo
sky blue
- 5002 blu oltremare
ultramarine blue
- 0030 verde mela
apple green
- 7045 grigio silver
silver grey
- 9005 nero assoluto
absolute black



Sgabello Brera.ss in legno di faggio laccato,
colore arancione mandarino.
Brera.ss stool in lacquered beech wood,
tangerine orange colour.

Dandy_Dandy.tt_Dandy.w_Dandy.b
Dandy Iron_Dandy Iron.ss_Dandy swing



Dandy...

Dandy

Design Cighetti & Hugnot

Sedia in legno di rovere naturale o laccato.
Chair in natural or lacquered oak wood.

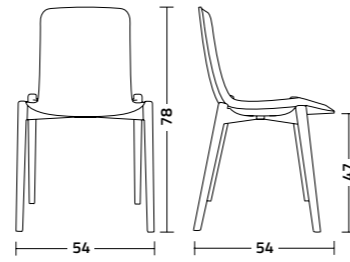

rovere - oak

- 0001 naturale
natural
- 0002 smoke
smoke
- 9005 nero assoluto
absolute black



Sedia Dandy con struttura e seduta in legno di rovere naturale.
Dandy chair with frame and seat in natural oak wood.





Dettaglio, sedia Dandy con struttura e seduta
in legno di rovere naturale.
Detail, Dandy chair with frame and seat
in natural oak wood.



Scatto laterale, sedia Dandy con struttura e seduta
in legno di rovere laccato, colore nero assoluto.
Side shoot, Dandy chair with frame and seat in
lacquered oak wood, absolute black colour.

Dandy.tt

Design CR&S Colico

Sedia con struttura in acciaio verniciato e seduta realizzata in legno di rovere naturale o laccato.

Chair with painted steel frame and seat made of natural or lacquered oak wood.

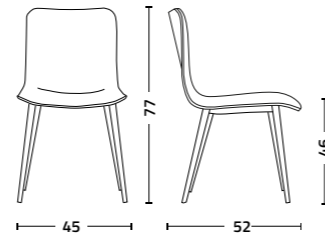

struttura - frame
acciaio - steel

- 9003 bianco zucchero
sugar white
- 7032 beige champagne
champagne beige
- 7022 grigio piombo
lead grey
- 9005 nero assoluto
absolute black

seduta - seat
rovere - oak

- 0001 naturale
natural
- 0002 smoke
smoke
- 9005 nero assoluto
absolute black



Sedia Dandy.tt con struttura in acciaio verniciato, colore grigio piombo e seduta in legno di rovere naturale.
Dandy.tt chair with painted steel frame, lead grey colour and natural oak wood seat.



Dandy.w

Design CR&S Colico

Sedia in legno di rovere naturale o laccato.
Chair in natural or lacquered oak wood.

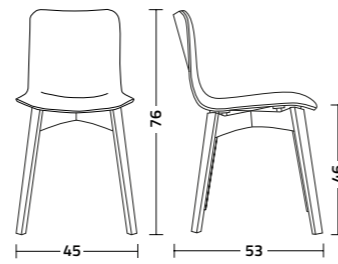

struttura - frame
rovere - oak

- 0001 naturale
natural
- 0002 smoke
smoke
- 9005 nero assoluto
absolute black



Sedia Dandy.w con struttura e seduta in legno di rovere naturale.
Dandy.w chair with frame and seat in natural oak wood.



Dandy.b

Design CR&S Colico

Sedia con struttura in acciaio cromato o verniciato e seduta realizzata in legno di rovere naturale o laccato.

Chair with chrome-plated or painted steel frame and seat made of natural or lacquered oak wood.

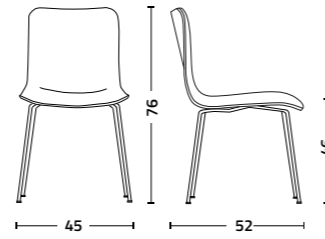

struttura - frame
acciaio - steel

- 9003 bianco zucchero
sugar white
- 1019 beige tortora
taupe beige
- 7032 beige champagne
champagne beige
- 7024 grigio antracite
charcoal grey
- 7022 grigio piombo
lead grey
- 9005 nero assoluto
absolute black
- 0070 cromo
chrome

seduta - seat
rovere - oak

- 0001 naturale
natural
- 0002 smoke
smoke
- 9005 nero assoluto
absolute black



Sedia Dandy.b con struttura in acciaio verniciato, colore beige champagne e seduta in legno di rovere laccato, colore nero assoluto.

Dandy.b chair with painted steel frame, champagne beige colour and lacquered oak wood seat, absolute black colour.



Sedia Dandy.b con struttura in acciaio verniciato,
colore grigio piombo e seduta in legno di rovere naturale.
Dandy.b chair with painted steel frame, lead grey colour
and natural oak wood seat.



Dettaglio, sedia Dandy.b con struttura in acciaio verniciato,
colore grigio piombo e seduta in legno di rovere laccato,
colore nero assoluto.
Detail, Dandy.b chair with painted steel frame, lead grey colour
and lacquered oak wood seat, absolute black colour.



Dandy Iron

Design CR&S Colico

Sedia con struttura in tondino di acciaio verniciato e seduta realizzata in legno di rovere naturale o laccato.

Chair with painted steel rod frame and seat made of natural or lacquered oak wood.

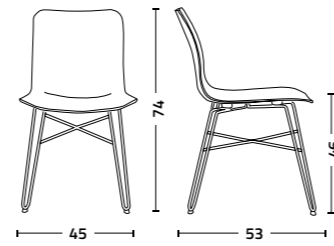

struttura - frame
tondino di acciaio - steel rod

- 9003 bianco zucchero
sugar white
- 9005 nero assoluto
absolute black

seduta - seat
rovere - oak

- 0001 naturale
natural
- 0002 smoke
smoke
- 9005 nero assoluto
absolute black



Sedia Dandy Iron con struttura in tondino di acciaio verniciato, colore nero assoluto e seduta in legno di rovere laccato, colore nero assoluto.

Dandy Iron chair with painted steel rod frame, absolute black colour and lacquered oak wood seat, absolute black colour.



Sullo sfondo: sedia Dandy Iron con struttura in tondino di acciaio verniciato, colore nero assoluto e seduta in legno di rovere laccato, nello stesso colore.
In primo piano: sedia Dandy Iron con struttura in tondino di acciaio verniciato, colore bianco zucchero e seduta in legno di rovere naturale.
On the background: Dandy Iron chair with painted steel rod frame, absolute black colour and lacquered oak wood seat, in the same colour.
On the foreground: Dandy Iron chair with painted steel rod frame, sugar white colour and natural oak wood seat.



Sedia Dandy Iron con struttura in tondino di acciaio verniciato, colore nero assoluto e seduta in legno di rovere naturale.
ft. tavolo Level.
Dandy Iron chair with painted steel rod frame, absolute black colour and natural oak wood seat.
ft. Level table.

Dandy Iron.ss

Design CR&S Colico

Sgabello con struttura in tondino di acciaio verniciato e seduta realizzata in legno di rovere naturale o laccato.

Stool with painted steel rod frame and seat made of natural or lacquered oak wood.

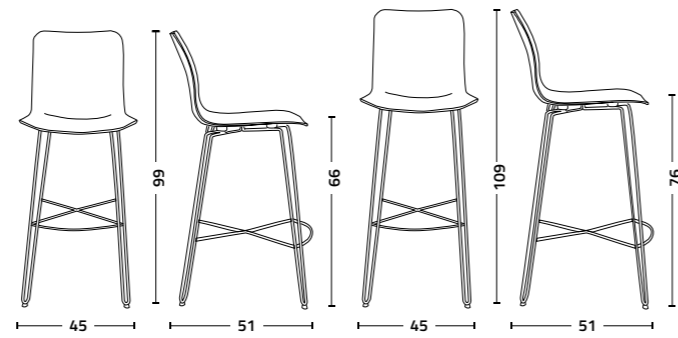

struttura - frame
tondino di acciaio - steel rod

- 9003 bianco zucchero
sugar white
- 9005 nero assoluto
absolute black

seduta - seat
rovere - oak

- 0001 naturale
natural
- 0002 smoke
smoke
- 9005 nero assoluto
absolute black



Sgabelli Dandy Iron.ss con struttura in tondino di acciaio verniciato, colore nero assoluto e bianco zucchero; per entrambi gli sgabelli, seduta in legno di rovere naturale.

Dandy Iron.ss stools with painted steel rod frame, absolute black and sugar white colour; for both stools, seat in natural oak wood.



Dandy swing

Design CR&S Colico

Sgabello con base in alluminio verniciato o cromato; la struttura, girevole e regolabile in altezza tramite pistone a gas, è realizzata in acciaio verniciato o cromato; la seduta è realizzata in legno di rovere naturale o laccato.

Stool with painted or chrome-plated aluminium base; the frame, swiveling and height-adjustable through a gas piston, is made of painted or chrome-plated steel; its seat is made of natural or lacquered oak wood.

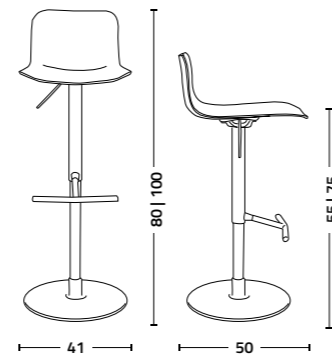

base - base
ALU alluminio - aluminium
struttura - frame
acciaio verniciato - painted steel

seduta - seat
rovere - oak

- 9003 bianco zucchero
sugar white
- 9005 nero assoluto
absolute black
- 0070 cromo
chrome

- 0001 naturale
natural
- 0002 smoke
smoke
- 9005 nero assoluto
absolute black



Da sinistra: sgabello Dandy swing con base in alluminio, struttura e pistone in acciaio verniciato, colore nero assoluto e seduta in legno di rovere laccato, nello stesso colore; sgabello Dandy swing con base in alluminio, struttura e pistone in acciaio verniciato, colore bianco zucchero e seduta in legno di rovere naturale.

From the left: Dandy swing stool with painted aluminium base, steel frame and piston, absolute black colour and lacquered oak wood seat, in the same colour; Dandy swing stool with painted aluminium base, steel frame and piston, sugar white colour and seat in natural oak wood.



Dettaglio e scatto laterale, sgabello Dandy swing con base in alluminio, struttura e pistone in acciaio verniciato, colore bianco zucchero e seduta in legno di rovere naturale.

Detail and side shoot, Dandy swing stool with painted aluminium base, steel frame and piston, sugar white colour and seat in natural oak wood.



Pedalò

Design F. Di Martino

Collezione di sgabelli regolabili in altezza con struttura in acciaio verniciato e seduta in cuoio Brooks.

Collection of height-adjustable stools with painted steel frame and Brooks leather seat.

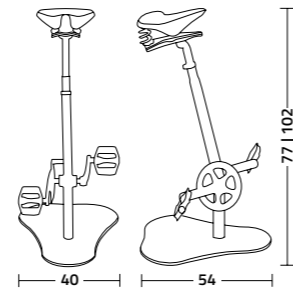

struttura - frame
acciaio - steel

- 9003 bianco zucchero
sugar white
- 6019 verde acquamarina
aquamarine green
- 8000 oro
gold
- 9005 nero assoluto
absolute black

seduta - seat
cuoio - leather

- 0001 naturale
natural
- 9005 nero assoluto
absolute black



Sgabello Pedalò.memorial con struttura in acciaio verniciato, colore verde acquamarina; pedale in alluminio dotato di cinghie in cuoio, con seduta e borsa portattrezzi in cuoio Brooks, colore naturale.

Pedalò.memorial stool with painted steel frame, aquamarine green colour; aluminium pedal fitted with leather straps, with Brooks leather seat and the tool pouch, natural colour.



Sgabello Pedalò con struttura in acciaio verniciato, colore nero assoluto; pedale in alluminio e seduta in cuoio Brooks, colore nero assoluto.
 Pedalò stool with painted steel frame, absolute black colour; aluminium pedal and Brooks leather, absolute black colour.



Sgabello Pedalò con struttura in acciaio verniciato, colore nero assoluto; pedale in plastica e seduta in cuoio Brooks, colore naturale.
 Pedalò stool with painted steel frame, absolute black colour; plastic pedal and Brooks leather, natural colour.

exclusive

Imbottiture e materiali pregiati per prodotti iconici, senza tempo.
Padding and precious materials for iconic products, out of time.

exclusive product

Odyssée.m

Design P. Borgonovo

Poltroncina con struttura e schienale in legno di frassino naturale o laccato; la seduta può essere con paglia oppure imbottita e rivestita in tessuto, ecopelle o pelle.

Armchair with natural or lacquered ash wood frame and back; its seat can be in straw or padded and upholstered with fabric, artificial leather or real leather.

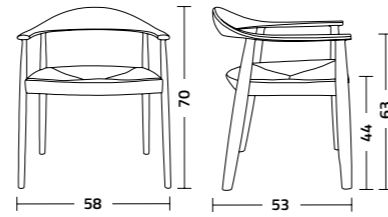

struttura - frame frassino - ash

- 0001 naturale natural
- 0002 smoke smoke
- 9005 nero assoluto absolute black

seduta - seat paglia - straw

- 0001 naturale natural

seduta - seat tessuto - fabric vivido

- 03 grigio tortora taupe grey
- 59 rosa pastello pastel pink
- 57 rosso borgogna burgundy red
- 42 verde marino marine green
- 05 grigio antracite charcoal grey
- 32 nero assoluto absolute black

seduta - seat tessuto - fabric magico

- 01 bianco avorio ivory white
- 11 giallo senape mustard yellow
- 03 beige avana fallow beige
- 02 beige canapa hemp beige
- 04 marrone glacé glacé brown
- 05 grigio silver silver grey
- 06 grigio ardesia slate grey

seduta - seat tessuto - fabric fiocco

- 0206 beige canapa hemp beige
- 8008 rosa corallo coral pink
- 9260 arancione ruggine rust orange
- 3103 rosso scarlatto scarlet red
- 6714 verde mirto brunswick green
- 5667 verde ottanio teal green
- 5554 viola indaco indigo violet
- 4765 marrone glacé glacé brown
- 0408 grigio antracite charcoal grey

seduta - seat ecopelle - artificial leather magnum

- 102 bianco zucchero sugar white
- 118 beige tortora taupe beige
- 113 grigio fango taupe grey
- 129 rosso scarlatto scarlet red
- 110 marrone caffè coffee brown
- 126 grigio silver silver grey
- 120 grigio antracite charcoal grey
- 101 nero assoluto absolute black

seduta - seat ecopelle - artificial leather vintage

- 004 marrone noce walnut brown
- 007 marrone glacé glacé brown
- 002 grigio antracite charcoal grey
- 001 nero assoluto absolute black

seduta - seat ecopelle - artificial leather econabuk

- 79 giallo senape mustard yellow
- 29 rosso rubino ruby red
- 60 verde menta mint green
- 15 grigio perla pearl grey
- 44 grigio antracite charcoal grey
- 13 nero assoluto absolute black

seduta - seat pelle - leather alysée

- 0010 bianco zucchero sugar white
- 0090 beige avana sand beige
- 1514 giallo senape mustard yellow
- 0050 rosso rubino ruby red
- 1532 rosso borgogna burgundy red
- 1518 marrone bruno umber brown
- 1524 grigio antracite charcoal grey
- 0040 nero assoluto absolute black



Poltroncina Odyssée.m con struttura e schienale in legno di frassino laccato smoke e seduta in paglia naturale. ft. tavolo Cargo.

Odyssée.m armchair with smoke lacquered ash wood frame and back, seat in natural straw. ft. Cargo table.



Odyssée

Design P. Borgonovo

Poltroncina con struttura e schienale in legno di frassino naturale o laccato; la seduta può essere con paglia naturale intrecciata a mano, oppure imbottita e rivestita in tessuto, ecopelle o pelle.

Armchair with natural or lacquered ash wood frame and back; its seat can be with natural hand-crafted straw or padded and upholstered with fabric, artificial leather or real leather.

exclusive product

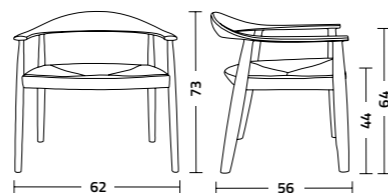

struttura - frame frassino - ash

- 0001 naturale natural
- 0002 smoke smoke
- 9005 nero assoluto absolute black

seduta - seat paglia - straw

- 0001 naturale natural

seduta - seat tessuto - fabric vivido

- 03 grigio tortora taupe grey
- 59 rosa pastello pastel pink
- 57 rosso borgogna burgundy red
- 42 verde marino marine green
- 05 grigio antracite charcoal grey
- 32 nero assoluto absolute black

seduta - seat tessuto - fabric magico

- 01 bianco avorio ivory white
- 11 giallo senape mustard yellow
- 03 beige avana fallow beige
- 02 beige canapa hemp beige
- 04 marrone glacé glacé brown
- 05 grigio silver silver grey
- 06 grigio ardesia slate grey

seduta - seat tessuto - fabric fiocco

- 0206 beige canapa hemp beige
- 8008 rosa corallo coral pink
- 9260 arancione ruggine rust orange
- 3103 rosso scarlatto scarlet red
- 6714 verde mirto brunswick green
- 5667 verde ottanio teal green
- 5554 viola indaco indigo violet
- 4765 marrone glacé glacé brown
- 0408 grigio antracite charcoal grey
- 0802 nero assoluto absolute black

seduta - seat ecopelle - artificial leather magnum

- 102 bianco zucchero sugar white
- 118 beige tortora taupe beige
- 113 grigio fango taupe grey
- 129 rosso scarlatto scarlet red
- 110 marrone caffè coffee brown
- 126 grigio silver silver grey
- 120 grigio antracite charcoal grey
- 101 nero assoluto absolute black

seduta - seat ecopelle - artificial leather vintage

- 004 marrone noce walnut brown
- 007 marrone glacé glacé brown
- 002 grigio antracite charcoal grey
- 001 nero assoluto absolute black

seduta - seat ecopelle - artificial leather econabuk

- 79 giallo senape mustard yellow
- 29 rosso rubino ruby red
- 60 verde menta mint green
- 15 grigio perla pearl grey
- 44 grigio antracite charcoal grey
- 13 nero assoluto absolute black

seduta - seat pelle - leather alysée

- 0010 bianco zucchero sugar white
- 0090 beige avana sand beige
- 1514 giallo senape mustard yellow
- 0050 rosso rubino ruby red
- 1532 rosso borgogna burgundy red
- 1518 marrone bruno umber brown
- 1524 grigio antracite charcoal grey
- 0040 nero assoluto absolute black



Poltroncina Odyssée con struttura e schienale in legno di frassino laccato smoke e seduta in paglia naturale intrecciata a mano. ft. tavolo Slash.

Odyssée armchair with smoke lacquered ash wood frame and back, seat in natural hand-crafted straw. ft. Slash table.



Poltroncina Odyssee con struttura e schienale in legno di frassino laccato smoke e seduta imbottita e rivestita in pelle, Alysée, colore beige avana.
Odyssee armchair with smoke lacquered ash wood frame and back, seat padded and upholstered with leather, Alysée, sand beige colour.



Dettaglio, poltroncina Odyssee con struttura e schienale in legno di frassino laccato, colore nero assoluto e seduta in paglia naturale intrecciata a mano.
Detail, Odyssee armchair with lacquered ash wood frame and back, absolute black colour and seat in natural hand-crafted straw.

Odyssée.xl

Design P. Borgonovo

Poltrona con struttura e schienale in legno di frassino naturale o laccato; la seduta può essere con paglia naturale intrecciata a mano, oppure imbottita e rivestita in tessuto, ecopelle o pelle.

Armchair with natural or lacquered ash wood frame and back; its seat can be with natural hand-crafted straw or padded and upholstered with fabric, artificial leather or real leather.

exclusive product

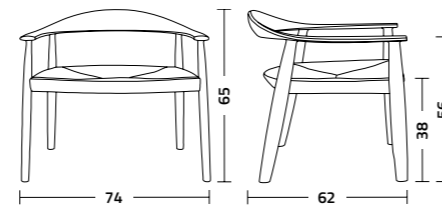

struttura - frame frassino - ash

- 0001 naturale natural
- 0002 smoke smoke
- 9005 nero assoluto absolute black

seduta - seat paglia - straw

- 0001 naturale natural

seduta - seat tessuto - fabric vivido

- 03 grigio tortora taupe grey
- 59 rosa pastello pastel pink
- 57 rosso borgogna burgundy red
- 42 verde marino marine green
- 05 grigio antracite charcoal grey
- 32 nero assoluto absolute black

seduta - seat tessuto - fabric magico

- 01 bianco avorio ivory white
- 11 giallo senape mustard yellow
- 03 beige avana fallow beige
- 02 beige canapa hemp beige
- 04 marrone glacé glacé brown
- 05 grigio silver silver grey
- 06 grigio ardesia slate grey

seduta - seat tessuto - fabric fiocco

- 0206 beige canapa hemp beige
- 8008 rosa corallo coral pink
- 9260 arancione ruggine rust orange
- 3103 rosso scarlatto scarlet red
- 6714 verde mirto brunswick green
- 5667 verde ottanio teal green
- 5554 viola indaco indigo violet
- 4765 marrone glacé glacé brown
- 0408 grigio antracite charcoal grey
- 0802 nero assoluto absolute black

seduta - seat ecopelle - artificial leather magnum

- 102 bianco zucchero sugar white
- 118 beige tortora taupe beige
- 113 grigio fango taupe grey
- 129 rosso scarlatto scarlet red
- 110 marrone caffè coffee brown
- 126 grigio silver silver grey
- 120 grigio antracite charcoal grey
- 101 nero assoluto absolute black

seduta - seat ecopelle - artificial leather vintage

- 004 marrone noce walnut brown
- 007 marrone glacé glacé brown
- 002 grigio antracite charcoal grey
- 001 nero assoluto absolute black

seduta - seat ecopelle - artificial leather econabuk

- 79 giallo senape mustard yellow
- 29 rosso rubino ruby red
- 60 verde menta mint green
- 15 grigio perla pearl grey
- 44 grigio antracite charcoal grey
- 13 nero assoluto absolute black

seduta - seat pelle - leather alysée

- 0010 bianco zucchero sugar white
- 0090 beige avana sand beige
- 1514 giallo senape mustard yellow
- 0050 rosso rubino ruby red
- 1532 rosso borgogna burgundy red
- 1518 marrone bruno umber brown
- 1524 grigio antracite charcoal grey
- 0040 nero assoluto absolute black



Poltrona Odyssée.xl con struttura e schienale in legno di frassino naturale e seduta in paglia naturale intrecciata a mano.
Odyssée.xl armchair with natural ash wood frame and back, seat in natural hand-crafted straw.

Poltrona Odyssee.xl con struttura e schienale
in legno di frassino naturale e seduta in
paglia naturale intrecciata a mano.
Odyssee.xl armchair with natural ash wood frame
and back, seat in natural hand-crafted straw.

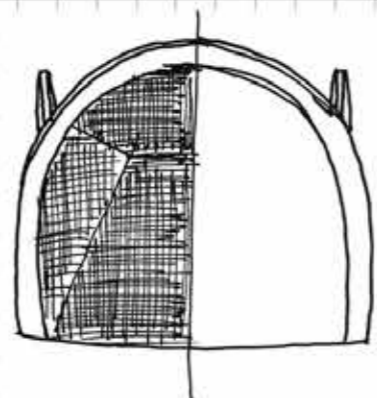
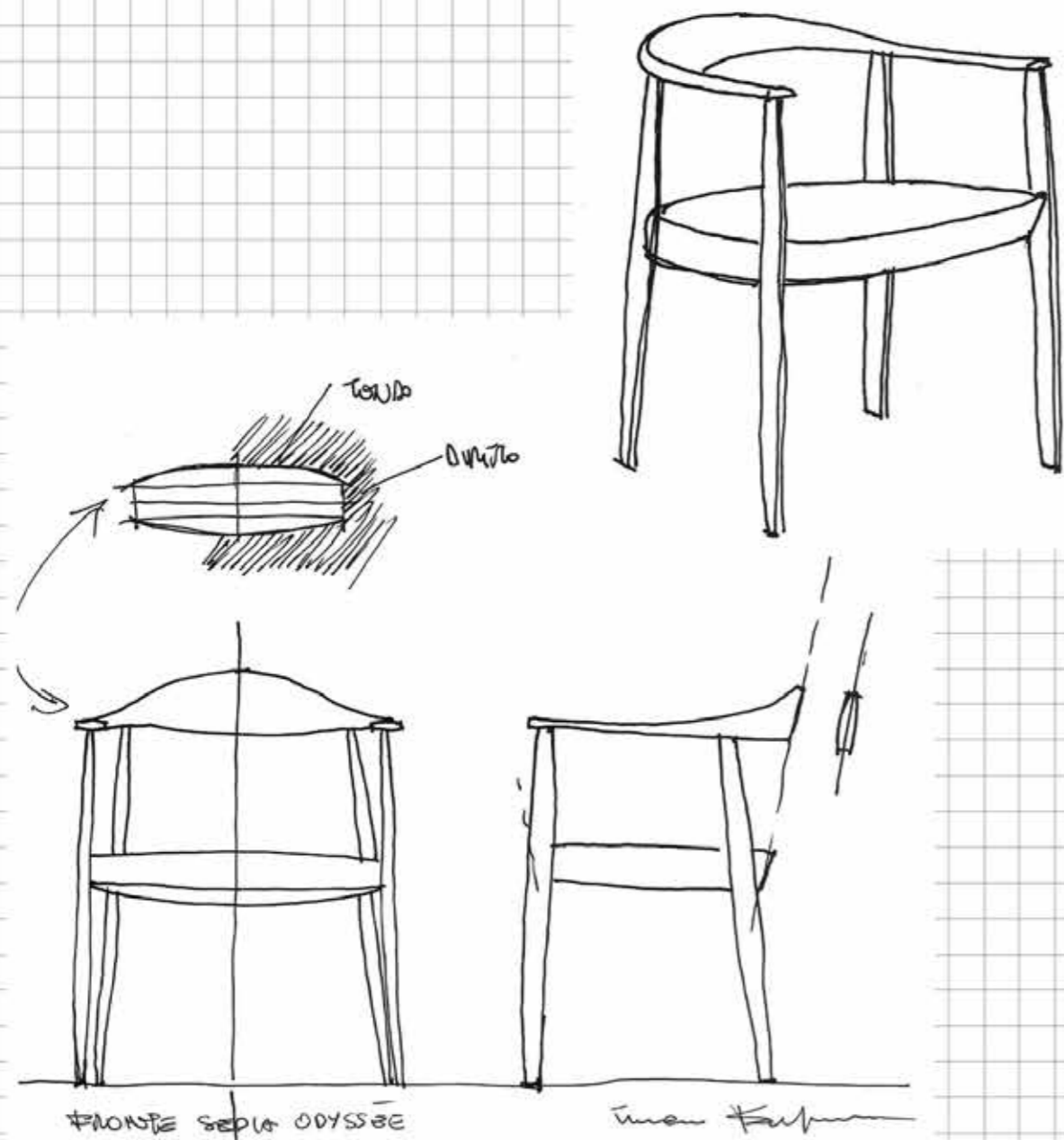



Poltrona Odyssee.xl con struttura e schienale in legno di frassino laccato, colore nero assoluto e seduta imbottita e rivestita in tessuto, Vivido, colore verde marino.

Odyssee.xl armchair with lacquered ash wood frame and back, absolute black colour and seat padded and upholstered with fabric, Vivido, marine green colour.

Diana

Design W. Colico

Sedia con struttura in legno di frassino naturale o laccato e puntali in acciaio cromato. Seduta e schienale sono imbottiti e rivestiti in tessuto, ecopelle o pelle.

Chair with natural or lacquered ash wood frame and chrome-plated steel leg caps. Seat and back are padded and upholstered with fabric, artificial leather or real leather.

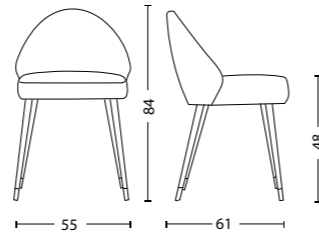

struttura - frame
frassino - ash

- 0001 naturale natural
- 0002 smoke smoke
- 9005 nero assoluto absolute black

puntale - leg cap
acciaio - steel

- 0076 cromo ottone brass chrome

seduta - seat
tessuto - fabric

- 03 grigio tortora taupe grey
- 59 rosa pastello pastel pink
- 57 rosso borgogna burgundy red
- 42 verde marino marine green
- 05 grigio antracite charcoal grey
- 32 nero assoluto absolute black

seduta - seat
tessuto - fabric

- 01 bianco avorio ivory white
- 11 giallo senape mustard yellow
- 03 beige avana fallow beige
- 02 beige canapa hemp beige
- 04 marrone glacé glacé brown
- 05 grigio silver silver grey
- 06 grigio ardesia slate grey

seduta - seat
tessuto - fabric

- 0206 beige canapa hemp beige
- 8008 rosa corallo coral pink
- 9260 arancione ruggine rust orange
- 3103 rosso scarlatto scarlet red
- 6714 verde mirto brunswick green
- 5667 verde ottanio teal green
- 5554 viola indaco indigo violet
- 4765 marrone glacé glacé brown
- 0408 grigio antracite charcoal grey
- 0802 nero assoluto absolute black

seduta - seat
ecopelle - artificial leather

- 102 bianco zucchero sugar white
- 118 beige tortora taupe beige
- 113 grigio fango taupe grey
- 129 rosso scarlatto scarlet red
- 110 marrone caffè coffee brown
- 126 grigio silver silver grey
- 120 grigio antracite charcoal grey
- 101 nero assoluto absolute black

seduta - seat
ecopelle - artificial leather

- 004 marrone noce walnut brown
- 007 marrone glacé glacé brown
- 002 grigio antracite charcoal grey
- 001 nero assoluto absolute black

seduta - seat
ecopelle - artificial leather

- 79 giallo senape mustard yellow
- 29 rosso rubino ruby red
- 60 verde menta mint green
- 15 grigio perla pearl grey
- 44 grigio antracite charcoal grey
- 13 nero assoluto absolute black

seduta - seat
pelle - leather

- 0010 bianco zucchero sugar white
- 0090 beige avana sand beige
- 1514 giallo senape mustard yellow
- 0050 rosso rubino ruby red
- 1532 rosso borgogna burgundy red
- 1518 marrone bruno umber brown
- 1524 grigio antracite charcoal grey
- 0040 nero assoluto absolute black



Dettaglio, sedia Diana con struttura in legno di frassino laccato, colore nero assoluto e puntali in acciaio cromato, colore ottone; seduta e schienale imbottiti e rivestiti in ecopelle, Econabuk, colore verde menta.

Detail, Diana chair with lacquered ash wood frame, absolute black colour and chrome-plated steel leg caps, brass colour; seat and back padded and upholstered with artificial leather, Econabuk, mint green colour.



Diana.ss

Design W. Colico

Sgabello con struttura in legno di frassino naturale o laccato e puntali in acciaio cromato. Seduta e schienale sono imbottiti e rivestiti in tessuto, ecopelle o pelle.

Stool with natural or lacquered ash wood frame and chrome-plated steel leg caps. Seat and back are padded and upholstered with fabric, artificial leather or real leather.

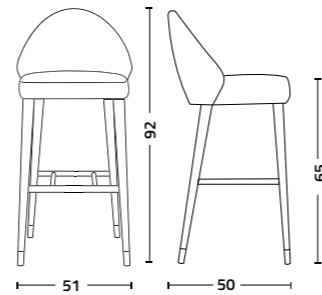

struttura - frame
frassino - ash

- 0001 naturale natural
- 0002 smoke smoke
- 9005 nero assoluto absolute black

puntale - leg cap
acciaio - steel

- 0076 cromo ottone brass chrome

seduta - seat
tessuto - fabric
vivido

- 03 grigio tortora taupe grey
- 59 rosa pastello pastel pink
- 57 rosso borgogna burgundy red
- 42 verde marino marine green
- 05 grigio antracite charcoal grey
- 32 nero assoluto absolute black

seduta - seat
tessuto - fabric
magico

- 01 bianco avorio ivory white
- 11 giallo senape mustard yellow
- 03 beige avana fallow beige
- 02 beige canapa hemp beige
- 04 marrone glacé glacé brown
- 05 grigio silver silver grey
- 06 grigio ardesia slate grey

seduta - seat
tessuto - fabric
fiocco

- 0206 beige canapa hemp beige
- 8008 rosa corallo coral pink
- 9260 arancione ruggine rust orange
- 3103 rosso scarlatto scarlet red
- 6714 verde mirto brunswick green
- 5667 verde ottanio teal green
- 5554 viola indaco indigo violet
- 4765 marrone glacé glacé brown
- 0408 grigio antracite charcoal grey
- 0802 nero assoluto absolute black

seduta - seat
ecopelle - artificial leather
magnum

- 102 bianco zucchero sugar white
- 118 beige tortora taupe beige
- 113 grigio fango taupe grey
- 129 rosso scarlatto scarlet red
- 110 marrone caffè coffee brown
- 126 grigio silver silver grey
- 120 grigio antracite charcoal grey
- 101 nero assoluto absolute black

seduta - seat
ecopelle - artificial leather
vintage

- 004 marrone noce walnut brown
- 007 marrone glacé glacé brown
- 002 grigio antracite charcoal grey
- 001 nero assoluto absolute black

seduta - seat
ecopelle - artificial leather
econabuk

- 79 giallo senape mustard yellow
- 29 rosso rubino ruby red
- 60 verde menta mint green
- 15 grigio perla pearl grey
- 44 grigio antracite charcoal grey
- 13 nero assoluto absolute black

seduta - seat
pelle - leather
alysée

- 0010 bianco zucchero sugar white
- 0090 beige avana sand beige
- 1514 giallo senape mustard yellow
- 0050 rosso rubino ruby red
- 1532 rosso borgogna burgundy red
- 1518 marrone bruno umber brown
- 1524 grigio antracite charcoal grey
- 0040 nero assoluto absolute black



Dettaglio, sgabello Diana.ss con struttura in legno di frassino laccato, colore nero assoluto e puntali in acciaio cromato, colore ottone; seduta e schienale imbottiti e rivestiti in tessuto, Vivido, colore rosa pastello.

Detail, Diana.ss stool with lacquered ash wood frame, absolute black colour and chrome-plated steel leg caps, brass colour; seat and back padded and upholstered with fabric, Vivido, pastel pink colour.



exclusive product

Diana.f

Design W. Colico

Sedia con struttura in legno di frassino naturale o laccato e puntali in acciaio cromato. Seduta e schienale sono imbottiti e rivestiti in tessuto, ecopelle o pelle.

Chair with natural or lacquered ash wood frame and chrome-plated steel leg caps. Seat and back are padded and upholstered with fabric, artificial leather or real leather.

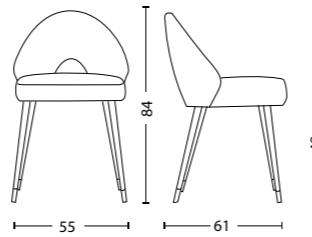

struttura - frame frassino - ash

- 0001 naturale natural
- 0002 smoke smoke
- 9005 nero assoluto absolute black

puntale - leg cap acciaio - steel

- 0076 cromo ottone brass chrome

seduta - seat tessuto - fabric vivido

- 03 grigio tortora taupe grey
- 59 rosa pastello pastel pink
- 57 rosso borgogna burgundy red
- 42 verde marino marine green
- 05 grigio antracite charcoal grey
- 32 nero assoluto absolute black

seduta - seat tessuto - fabric magico

- 01 bianco avorio ivory white
- 11 giallo senape mustard yellow
- 03 beige avana fallow beige
- 02 beige canapa hemp beige
- 04 marrone glacé glacé brown
- 05 grigio silver silver grey
- 06 grigio ardesia slate grey

seduta - seat tessuto - fabric fiocco

- 0206 beige canapa hemp beige
- 8008 rosa corallo coral pink
- 9260 arancione ruggine rust orange
- 3103 rosso scarlatto scarlet red
- 6714 verde mirto brunswick green
- 5667 verde ottanio teal green
- 5554 viola indaco indigo violet
- 4765 marrone glacé glacé brown
- 0408 grigio antracite charcoal grey
- 0802 nero assoluto absolute black

seduta - seat ecopelle - artificial leather magnum

- 102 bianco zucchero sugar white
- 118 beige tortora taupe beige
- 113 grigio fango taupe grey
- 129 rosso scarlatto scarlet red
- 110 marrone caffè coffee brown
- 126 grigio silver silver grey
- 120 grigio antracite charcoal grey
- 101 nero assoluto absolute black

seduta - seat ecopelle - artificial leather vintage

- 004 marrone noce walnut brown
- 007 marrone glacé glacé brown
- 002 grigio antracite charcoal grey
- 001 nero assoluto absolute black

seduta - seat ecopelle - artificial leather econabuk

- 79 giallo senape mustard yellow
- 29 rosso rubino ruby red
- 60 verde menta mint green
- 15 grigio perla pearl grey
- 44 grigio antracite charcoal grey
- 13 nero assoluto absolute black

seduta - seat pelle - leather alysée

- 0010 bianco zucchero sugar white
- 0090 beige avana sand beige
- 1514 giallo senape mustard yellow
- 0050 rosso rubino ruby red
- 1532 rosso borgogna burgundy red
- 1518 marrone bruno umber brown
- 1524 grigio antracite charcoal grey
- 0040 nero assoluto absolute black



Sedia Diana.f con struttura in legno di frassino laccato, colore nero assoluto e puntali in acciaio cromato, colore ottone; seduta e schienale imbottiti e rivestiti in ecopelle, Econabuk, colore verde menta.
Diana.f chair with lacquered ash wood frame, absolute black colour and chrome-plated steel leg caps, brass colour; seat and back padded and upholstered with artificial leather, Econabuk, mint green colour.



Diana.f.ss

Design W. Colico

Sgabello con struttura in legno di frassino naturale o laccato e puntali in acciaio cromato. Seduta e schienale sono imbottiti e rivestiti in tessuto, ecopelle o pelle.

Stool with natural or lacquered ash wood frame and chrome-plated steel leg caps, brass colour; seat and back padded and upholstered with fabric, artificial leather or real leather.

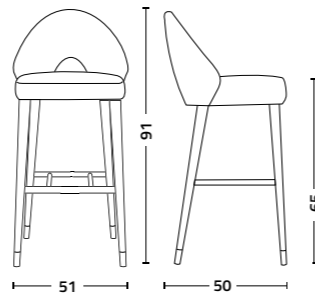

struttura - frame
frassino - ash

- 0001 naturale natural
- 0002 smoke smoke
- 9005 nero assoluto absolute black

puntale - leg cap
acciaio - steel

- 0076 cromo ottone brass chrome

seduta - seat
tessuto - fabric
vivido

- 03 grigio tortora taupe grey
- 59 rosa pastello pastel pink
- 57 rosso borgogna burgundy red
- 42 verde marino marine green
- 05 grigio antracite charcoal grey
- 32 nero assoluto absolute black

seduta - seat
tessuto - fabric
magico

- 01 bianco avorio ivory white
- 11 giallo senape mustard yellow
- 03 beige avana fallow beige
- 02 beige canapa hemp beige
- 04 marrone glacé glacé brown
- 05 grigio silver silver grey
- 06 grigio ardesia slate grey

seduta - seat
tessuto - fabric
fiocco

- 0206 beige canapa hemp beige
- 8008 rosa corallo coral pink
- 9260 arancione ruggine rust orange
- 3103 rosso scarlatto scarlet red
- 6714 verde mirto brunswick green
- 5667 verde ottanio teal green
- 5554 viola indaco indigo violet
- 4765 marrone glacé glacé brown
- 0408 grigio antracite charcoal grey
- 0802 nero assoluto absolute black

seduta - seat
ecopelle - artificial leather
magnum

- 102 bianco zucchero sugar white
- 118 beige tortora taupe beige
- 113 grigio fango taupe grey
- 129 rosso scarlatto scarlet red
- 110 marrone caffè coffee brown
- 126 grigio silver silver grey
- 120 grigio antracite charcoal grey
- 101 nero assoluto absolute black

seduta - seat
ecopelle - artificial leather
vintage

- 004 marrone noce walnut brown
- 007 marrone glacé glacé brown
- 002 grigio antracite charcoal grey
- 001 nero assoluto absolute black

seduta - seat
ecopelle - artificial leather
econabuk

- 79 giallo senape mustard yellow
- 29 rosso rubino ruby red
- 60 verde menta mint green
- 15 grigio perla pearl grey
- 44 grigio antracite charcoal grey
- 13 nero assoluto absolute black

seduta - seat
pelle - leather
alysée

- 0010 bianco zucchero sugar white
- 0090 beige avana sand beige
- 1514 giallo senape mustard yellow
- 0050 rosso rubino ruby red
- 1532 rosso borgogna burgundy red
- 1518 marrone bruno umber brown
- 1524 grigio antracite charcoal grey
- 0040 nero assoluto absolute black



Sgabello Diana.f.ss con struttura in legno di frassino laccato, colore nero assoluto e puntali in acciaio cromato, colore ottone; seduta e schienale imbottiti e rivestiti in tessuto, Vivido, colore rosa pastello.

Diana.f.ss stool with lacquered ash wood frame, absolute black colour and chrome-plated steel leg caps, brass colour; seat and back padded and upholstered with fabric, Vivido, pastel pink colour.



Grace

Design P. Borgonovo

Sedia con struttura in legno di rovere naturale o laccato con seduta e schienale imbottiti e rivestiti in tessuto, ecopelle o pelle. Grace si presenta interamente rivestita nella sua versione Lux.

Chair with natural or lacquered oak wood frame with seat and back padded and upholstered with fabric, artificial leather or real leather. Grace is entirely upholstered in its Lux version.

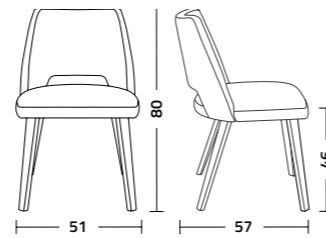

struttura - frame
rovere - oak

- 0001 naturale natural
- 0002 smoke smoke
- 9005 nero assoluto absolute black

rivestimento - upholstery
tessuto - fabric
vivido

- 03 grigio tortora taupe grey
- 59 rosa pastello pastel pink
- 57 rosso borgogna burgundy red
- 42 verde marino marine green
- 05 grigio antracite charcoal grey
- 32 nero assoluto absolute black

rivestimento - upholstery
tessuto - fabric
magico

- 01 bianco avorio ivory white
- 11 giallo senape mustard yellow
- 03 beige avana fallow beige
- 02 beige canapa hemp beige
- 04 marrone glacé glacé brown
- 05 grigio silver silver grey
- 06 grigio ardesia slate grey

rivestimento - upholstery
tessuto - fabric
fiocco

- 0206 beige canapa hemp beige
- 8008 rosa corallo coral pink
- 9260 arancione ruggine rust orange
- 3103 rosso scarlatto scarlet red
- 6714 verde mirto brunswick green
- 5667 verde ottanio teal green
- 5554 viola indaco indigo violet
- 4765 marrone glacé glacé brown
- 0408 grigio antracite charcoal grey
- 0802 nero assoluto absolute black

rivestimento - upholstery
ecopelle - artificial leather
magnum

- 102 bianco zucchero sugar white
- 118 beige tortora taupe beige
- 113 grigio fango taupe grey
- 129 rosso scarlatto scarlet red
- 110 marrone caffè coffee brown
- 126 grigio silver silver grey
- 120 grigio antracite charcoal grey
- 101 nero assoluto absolute black

rivestimento - upholstery
ecopelle - artificial leather
vintage

- 004 marrone noce walnut brown
- 007 marrone glacé glacé brown
- 002 grigio antracite charcoal grey
- 001 nero assoluto absolute black

rivestimento - upholstery
ecopelle - artificial leather
econabuk

- 79 giallo senape mustard yellow
- 29 rosso rubino ruby red
- 60 verde menta mint green
- 15 grigio perla pearl grey
- 44 grigio antracite charcoal grey
- 13 nero assoluto absolute black

rivestimento - upholstery
pelle - leather
alysée

- 0010 bianco zucchero sugar white
- 0090 beige avana sand beige
- 1514 giallo senape mustard yellow
- 0050 rosso rubino ruby red
- 1532 rosso borgogna burgundy red
- 1518 marrone bruno umber brown
- 1524 grigio antracite charcoal grey
- 0040 nero assoluto absolute black



Nella pagina accanto:
Sedia Grace con struttura in legno di rovere laccato smoke, seduta e schienale imbottiti e rivestiti in tessuto, Fiocco, colore marrone glacé.

On the opposite page:
Grace chair with smoke lacquered oak wood frame, seat and back padded and upholstered with fabric, Fiocco, glacé brown colour.



Dettaglio e scatto, sedia Grace Lux interamente rivestita in tessuto, Fiocco, colore marrone glacé con cucitura piping in contrasto, colore rosso rubino.
Detail and shoot, Grace Lux chair entirely upholstered with fabric, Fiocco, glacé brown colour with piping contrasting stitching, ruby red colour.



Sedia Grace e poltroncina Grace.p con struttura in legno di rovere laccato, colore nero assoluto, seduta e schienale imbottiti e rivestiti in tessuto, Fiocco, colore verde ottanio. ft. tavolo V6.

Grace chair and Grace.p armchair with lacquered oak wood frame, absolute black colour, seat and back padded and upholstered with fabric, Fiocco, teal green colour. ft. V6 table.



exclusive product

Grace.p

Design P. Borgonovo

Poltroncina con struttura in legno di rovere naturale o laccato con seduta e schienale imbottiti e rivestiti in tessuto, ecopelle o pelle. Grace.p si presenta interamente rivestita nella sua versione Lux.

Armchair with natural or lacquered oak wood frame with seat and back padded and upholstered with fabric, artificial leather or real leather. Grace.p is entirely upholstered in its Lux version.

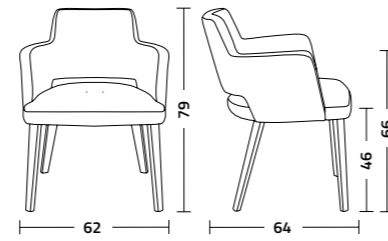

struttura - frame rovere - oak

- 0001 naturale natural
- 0002 smoke smoke
- 9005 nero assoluto absolute black

rivestimento - upholstery tessuto - fabric vivido

- 03 grigio tortora taupe grey
- 59 rosa pastello pastel pink
- 57 rosso borgogna burgundy red
- 42 verde marino marine green
- 05 grigio antracite charcoal grey
- 32 nero assoluto absolute black

rivestimento - upholstery tessuto - fabric magico

- 01 bianco avorio ivory white
- 11 giallo senape mustard yellow
- 03 beige avana fallow beige
- 02 beige canapa hemp beige
- 04 marrone glacé glacé brown
- 05 grigio silver silver grey
- 06 grigio ardesia slate grey

rivestimento - upholstery tessuto - fabric fiocco

- 0206 beige canapa hemp beige
- 8008 rosa corallo coral pink
- 9260 arancione ruggine rust orange
- 3103 rosso scarlatto scarlet red
- 6714 verde mirto brunswick green
- 5667 verde ottanio teal green
- 5554 viola indaco indigo violet
- 4765 marrone glacé glacé brown
- 0408 grigio antracite charcoal grey
- 0802 nero assoluto absolute black

rivestimento - upholstery ecopelle - artificial leather magnum

- 102 bianco zucchero sugar white
- 118 beige tortora taupe beige
- 113 grigio fango taupe grey
- 129 rosso scarlatto scarlet red
- 110 marrone caffè coffee brown
- 126 grigio silver silver grey
- 120 grigio antracite charcoal grey
- 101 nero assoluto absolute black

rivestimento - upholstery ecopelle - artificial leather vintage

- 004 marrone noce walnut brown
- 007 marrone glacé glacé brown
- 002 grigio antracite charcoal grey
- 001 nero assoluto absolute black

rivestimento - upholstery ecopelle - artificial leather econabuk

- 79 giallo senape mustard yellow
- 29 rosso rubino ruby red
- 60 verde menta mint green
- 15 grigio perla pearl grey
- 44 grigio antracite charcoal grey
- 13 nero assoluto absolute black

rivestimento - upholstery pelle - leather alysée

- 0010 bianco zucchero sugar white
- 0090 beige avana sand beige
- 1514 giallo senape mustard yellow
- 0050 rosso rubino ruby red
- 1532 rosso borgogna burgundy red
- 1518 marrone bruno umber brown
- 1524 grigio antracite charcoal grey
- 0040 nero assoluto absolute black



Dettaglio, poltroncina Grace.p Lux interamente rivestita in tessuto, Fiocco, colore grigio antracite.

Detail, Grace.p Lux armchair entirely upholstered with fabric, Fiocco, charcoal grey colour.



Sedie Grace Lux e poltroncine Grace.p Lux interamente rivestite in tessuto, Vivido, colore rosa pastello.
ft. lampade Can Can
Grace Lux chairs and Grace.p Lux armchairs entirely upholstered with fabric, Vivido, pastel rose colour.
ft. Can Can lamps.



Scatto posteriore poltroncina Grace.p Lux interamente rivestita in tessuto, vivido colore Verde Marino.
Back shot Grace.p Lux armchair entirely upholstered with fabric, Vivido, pastel marine green.



Dettaglio poltroncina Grace.p Lux interamente rivestita in tessuto, vivido colore Rosa pastello.
Detail Grace.p Lux armchair entirely upholstered with fabric, Vivido, pastel rose colour.



exclusive product

Giò

Design G. Parenti

Sedia con struttura in legno di faggio disidratato e laccato; seduta in corda nautica intrecciata a mano o imbottita e rivestita in tessuto o ecopelle.

Chair with dried and lacquered beech wood frame; seat in hand woven nautical rope or padded and upholstered with fabric or artificial leather.

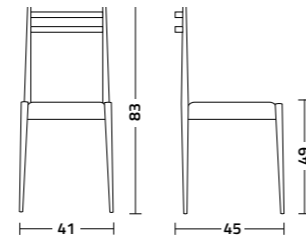

struttura - frame
faggio - beech

9005 nero assoluto
absolute black

seduta - seat
paglia - straw

9005 nero assoluto
absolute black

seduta - seat
tessuto - fabric
vivido

- 03 grigio tortora
taupe grey
- 59 rosa pastello
pastel pink
- 57 rosso borgogna
burgundy red
- 42 verde marino
marine green
- 05 grigio antracite
charcoal grey
- 32 nero assoluto
absolute black

seduta - seat
ecopelle - artificial leather
econabuk

- 79 giallo senape
mustard yellow
- 29 rosso rubino
ruby red
- 60 verde menta
mint green
- 15 grigio perla
pearl grey
- 44 grigio antracite
charcoal grey
- 13 nero assoluto
absolute black



In primo piano:
Sedia Giò con struttura in legno di faggio laccato, colore nero assoluto;
seduta imbottita e rivestita in tessuto, Vivido, colore nero assoluto.
Sullo sfondo:
Sedia Giò con struttura in legno di faggio laccato, colore nero assoluto;
seduta imbottita e rivestita in tessuto, Vivido, colore rosa pastello.



On the foreground:
Giò chair with lacquered beech wood frame, absolute black colour;
seat padded and upholstered with fabric, Vivido, absolute black colour.
On the background:
Giò chair with lacquered beech wood frame, absolute black colour;
seat padded and upholstered with fabric, Vivido, pastel pink colour.

Scatto laterale, sedia Giò con struttura in legno di faggio laccato, colore nero assoluto;
seduta imbottita e rivestita in tessuto, Vivido, colore verde marino.
Side shoot, Giò chair with lacquered beech wood frame, absolute black colour;
seat padded and upholstered with fabric, Vivido, marine green colour.



Scatto frontale, sedia Giò con struttura in legno di faggio laccato, colore nero assoluto;
seduta imbottita e rivestita in tessuto, Vivido, colore rosso borgogna.
Front shoot, Giò chair with lacquered beech wood frame, absolute black colour;
seat padded and upholstered with fabric, Vivido, burgundy red colour.





Scatto e dettaglio, sedia Giò con struttura in legno di faggio laccato, colore nero assoluto e seduta in corda nautica intrecciata a mano, nello stesso colore.
Shoot and detail, Giò chair with lacquered beech wood frame, absolute black colour and seat in hand woven nautical rope, in the same colour.





Waiya...

exclusive product

Waiya

Design E. Girotti

Sedia con struttura in tondino di acciaio verniciato o cromato e seduta imbottita e rivestita in tessuto cliente o ecopelle.

Chair with painted or chrome-plated steel rod frame and seat padded and upholstered with client's fabric or artificial leather.

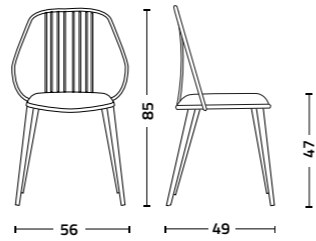

struttura - frame
tondino di acciaio - steel rod

- 7022 grigio piombo
lead grey
- 9005 nero assoluto
absolute black
- 0076 cromo ottone
brass chrome
- 0074 cromo rame
copper chrome

seduta - seat
ecopelle - artificial leather
econabuk

- 79 giallo senape
mustard yellow
- 29 rosso rubino
ruby red
- 60 verde menta
mint green
- 15 grigio perla
pearl grey
- 44 grigio antracite
charcoal grey
- 13 nero assoluto
absolute black



Sedia Waiya con struttura in tondino di acciaio cromato, colore ottone e seduta imbottita e rivestita in ecopelle, Econabuk, colore grigio perla.
ft. tavolo Circus.

Waiya Chair with chrome-plated steel rod frame, brass colour and seat padded and upholstered with artificial leather, Econabuk, pearl grey colour.
ft. Circus table.

Sedie Waiya con struttura in tondino di acciaio cromato, colore ottone e seduta imbottita e rivestita in ecopelle, Econabuk, colore grigio perla.
ft. tavolo Star.

Waiya chairs with chrome-plated steel rod frame, brass colour and seat padded and upholstered with artificial leather, Econabuk, pearl grey colour.
ft. Star table.



exclusive product

Waiya.ss

Design E. Girotti

Sgabello con struttura in tondino di acciaio verniciato o cromato e seduta imbottita e rivestita in tessuto cliente o ecopelle.

Stool with painted or chrome-plated steel rod frame and seat padded and upholstered with client's fabric or artificial leather.

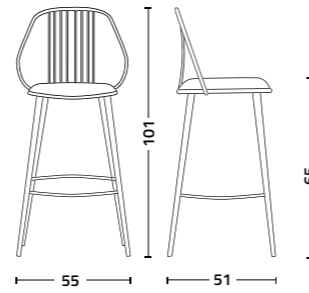

struttura - frame
tondino di acciaio - steel rod

- 7022 grigio piombo
lead grey
- 9005 nero assoluto
absolute black
- 0076 cromo ottone
brass chrome
- 0074 cromo rame
copper chrome

seduta - seat
ecopelle - artificial leather
econabuk

- 79 giallo senape
mustard yellow
- 29 rosso rubino
ruby red
- 60 verde menta
mint green
- 15 grigio perla
pearl grey
- 44 grigio antracite
charcoal grey
- 13 nero assoluto
absolute black



Sgabelli Waiya.ss e Waiya.p.ss con struttura in tondino di acciaio verniciato, colore grigio piombo e seduta imbottita e rivestita in ecopelle, Econabuk, colore grigio perla.

Waiya.ss and Waiya.p.ss stools with painted steel rod frame, lead grey colour and seat padded and upholstered with artificial leather, Econabuk, pearl grey colour.



Waiya.p

Design E. Girotti

Poltroncina con struttura e braccioli in tondino di acciaio verniciato o cromato e seduta imbottita e rivestita in tessuto cliente o ecopelle.

Armchair with painted or chrome-plated steel rod frame and armrests, seat padded and upholstered with client's fabric or artificial leather.

exclusive product

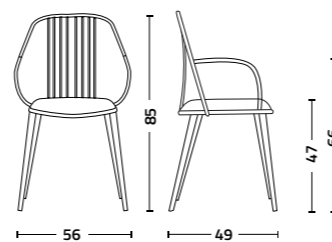

struttura - frame
tondino di acciaio - steel rod

- 7022 grigio piombo
lead grey
- 9005 nero assoluto
absolute black
- 0076 cromo ottone
brass chrome
- 0074 cromo rame
copper chrome

seduta - seat
ecopelle - artificial leather
econabuk

- 79 giallo senape
mustard yellow
- 29 rosso rubino
ruby red
- 60 verde menta
mint green
- 15 grigio perla
pearl grey
- 44 grigio antracite
charcoal grey
- 13 nero assoluto
absolute black



Sullo sfondo:
Dettaglio, poltroncina Waiya.p con struttura e braccioli
in tondino di acciaio cromato, colore rame e seduta imbottita
e rivestita in ecopelle, Econabuk, colore grigio perla.

On the background:
Detail, Waiya.p armchair with chrome-plated steel rod frame
and armrests, copper colour and seat padded and upholstered
with artificial leather, Econabuk, pearl grey colour.

Poltroncine Waiya.p con struttura e braccioli in tondino di acciaio cromato, colore rame e seduta imbottita e rivestita in ecopelle, Econabuk, colore grigio perla.
ft. tavolo Star.

Waiya.p armchairs with chrome-plated steel rod frame and armrests, copper colour and seat padded and upholstered with artificial leather, Econabuk, pearl grey colour.
ft. Star table.



exclusive product

Waiya.p.ss

Design E. Girotti

Sgabello con struttura e braccioli in tondino di acciaio verniciato o cromato e seduta imbottita e rivestita in tessuto cliente o ecopelle.

Stool with painted or chrome-plated steel rod frame and armrests, seat padded and upholstered with client's fabric or artificial leather.

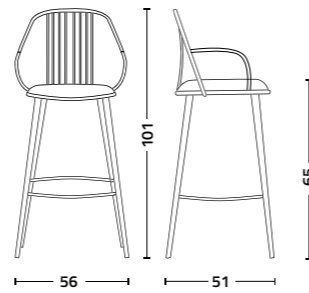

struttura - frame
tondino di acciaio - steel rod

- 7022 grigio piombo
lead grey
- 9005 nero assoluto
absolute black
- 0076 cromo ottone
brass chrome
- 0074 cromo rame
copper chrome

seduta - seat
ecopelle - artificial leather
econabuk

- 79 giallo senape
mustard yellow
- 29 rosso rubino
ruby red
- 60 verde menta
mint green
- 15 grigio perla
pearl grey
- 44 grigio antracite
charcoal grey
- 13 nero assoluto
absolute black



Sullo sfondo:
Sgabello Waiya.ss con struttura in tondino di acciaio cromato, colore ottone e seduta imbottita e rivestita in ecopelle, Econabuk, colore grigio perla.

In primo piano:
Sgabello Waiya.p.ss con struttura e braccioli in tondino di acciaio cromato, colore ottone e seduta imbottita e rivestita in ecopelle, Econabuk, colore grigio perla.



On the background:
Waiya.ss stool with chrome-plated steel rod frame, brass colour and seat padded and upholstered with artificial leather, Econabuk, pearl grey colour.

On the foreground:
Waiya.p.ss stool with chrome-plated steel rod frame and armrests, brass colour and seat padded and upholstered with artificial leather, Econabuk, pearl grey colour.



Jackie...

Jackie

Design S. Grassi

Sedia con struttura in tondino di acciaio verniciato o cromato e seduta rivestita a mano in cuoio.

Chair with painted or chrome-plated steel rod frame and seat hand-upholstered with leather.

exclusive product

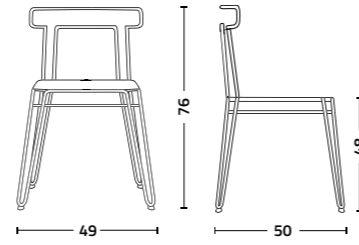

struttura - frame
tondino di acciaio - steel rod

- 7022 grigio piombo
lead grey
- 9005 nero assoluto
absolute black
- 0076 cromo ottone
brass chrome
- 0074 cromo rame
copper chrome

seduta - seat
cuoio - leather
cuoietto

- 100 beige naturale
natural beige
- 110 marrone caffè
coffee brown
- 101 nero assoluto
absolute black



Sedie Jackie con struttura in acciaio cromato, colore rame e seduta rivestita in cuoio, Cuoietto, colore beige naturale.

Jackie chairs with chrome-plated steel rod frame, copper colour and seat upholstered with leather, Cuoietto, natural beige colour.



Scatto laterale e posteriore, sedia Jackie con struttura
in acciaio verniciato, colore grigio piombo e seduta
rivestita in cuoio, Cuoietto, colore nero assoluto.
Side and back shoot, Jackie chair with painted
steel rod frame, lead grey colour and seat upholstered
with leather, Cuoietto, in the same absolute black colour.



exclusive product

Jackie.ss

Design S. Grassi

Sgabello con struttura in tondino di acciaio verniciato o cromato e seduta rivestita a mano in cuoio.

Stool with painted or chrome-plated steel rod frame and seat hand-upholstered with leather.

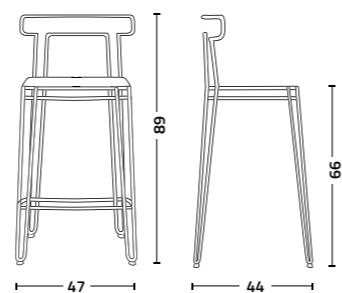

struttura - frame
tondino di acciaio - steel rod

- 7022 grigio piombo
lead grey
- 9005 nero assoluto
absolute black
- 0076 cromo ottone
brass chrome
- 0074 cromo rame
copper chrome

seduta - seat
cuoio - leather
cuoietto

- 100 beige naturale
natural beige
- 110 marrone caffè
coffee brown
- 101 nero assoluto
absolute black



Sgabelli Jackie.ss con struttura in tondino di acciaio verniciato, colore nero assoluto e cromato, colore rame; entrambi gli sgabelli hanno seduta rivestita in cuoio, Cuoietto, colore nero assoluto.

Jackie.ss stools with varnished steel rod frame, black colour and chrome-plated steel rod frame, copper colour; both stools have their seat upholstered with leather, Cuoietto, absolute black colour.



exclusive product

Dress_Dress Up

Design W. Colico

Sedie con struttura in acciaio interamente rivestite in cuoio.
Chairs with steel frame entirely upholstered with leather.

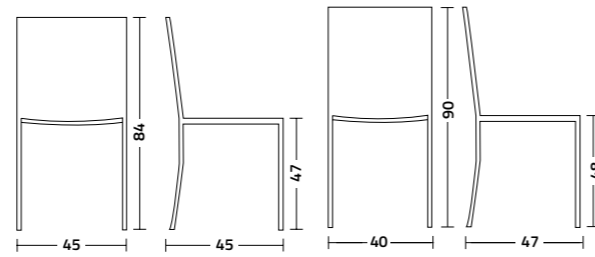

cuoio - leather
cuoietto

- 102 bianco latte
milk white
- 116 marrone glacé
glacé brown
- 110 marrone caffè
coffee brown
- 120 grigio antracite
charcoal grey
- 101 nero assoluto
absolute black



Sedia Dress Up interamente rivestita in cuoio,
Cuoietto, colore grigio antracite.
Dress Up chair entirely upholstered with leather,
Cuoietto, charcoal grey colour.

Sedia Dress Up interamente rivestita in cuoio,
Cuoietto, colore bianco latte.
Dress Up chair entirely upholstered with leather,
Cuoietto, milk white colour.



Sedia Dress Up interamente rivestita in cuoio,
Cuoietto, colore nero assoluto.
Dress Up chair entirely upholstered with
leather, Cuoietto, absolute black colour.



Nella pagina accanto:
Dettaglio, sedia Dress interamente rivestita in
cuoio, Cuoietto, colore bianco latte.

On the opposite page:
Detail, Dress chair entirely upholstered with
leather, Cuoietto, milk white colour.



exclusive product

Karlotta_Karlotta.p

Design W. Colico

Sedia e poltroncina con struttura in acciaio interamente rivestite in cuoio.

Chair and armchair with steel frame entirely upholstered with leather.

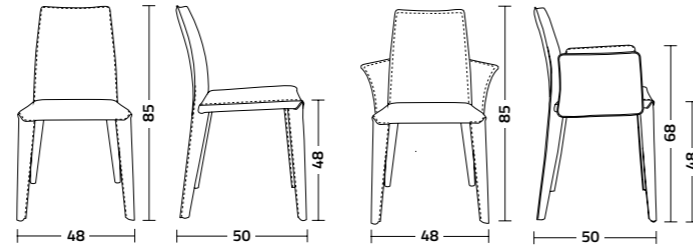

cuoio - leather
cuoietto

- 102 bianco latte
milk white
- 116 marrone glacé
glacé brown
- 110 marrone caffè
coffee brown
- 120 grigio antracite
charcoal grey
- 101 nero assoluto
absolute black

Dettaglio laterale, poltroncina Karlotta.p interamente rivestita in cuoio, Cuoietto, colore marrone caffè.
Side detail, Karlotta.p armchair entirely upholstered with leather, Cuoietto, coffee brown colour.



exclusive product

Karla

Design W. Colico

Sedia con struttura in acciaio interamente rivestita in cuoio.
Chair with steel frame entirely upholstered with leather.

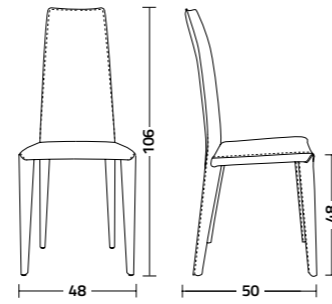

cuoio - leather
cuoietto

- 102 bianco latte
milk white
- 116 marrone glacé
glacé brown
- 110 marrone caffè
coffee brown
- 120 grigio antracite
charcoal grey
- 101 nero assoluto
absolute black



Nella pagina accanto:
Sedia Karla interamente rivestita in
cuoio, Cuoietto, colore marrone glacé.
On the opposite page:
Karla chair entirely upholstered with lea-
ther, Cuoietto, glacé brown colour.



tables

Circus

Design Fauciglietti Engineering

Tavolo con struttura centrale in tondino di acciaio verniciato o cromato. Il piano viene realizzato in cristallo o gres porcellanato ed è disponibile in varie misure, finiture e colori.

Table with central frame in painted or chrome-plated steel rod. Its top is made of glass or porcelain stoneware and is available in different sizes, finishes and colours.

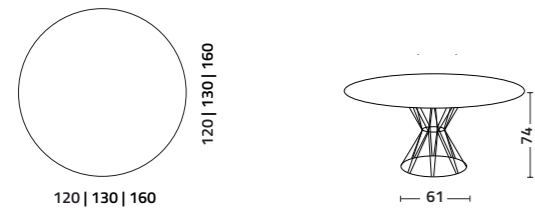

struttura - frame
tondino di acciaio - steel rod

- 7022 grigio piombo
lead grey
- 9005 nero assoluto
absolute black
- 0076 cromo ottone
brass chrome

piano - top
cristallo - glass

- 0001 trasparente
transparent
- 0063 fumé
smoke

piano - top
gres porcellanato
porcelain stoneware

- 7004 grigio cemento
cement grey
- 7024 grigio antracite
charcoal grey
- 0021 terrazzo grey
terrazzo grey
- 0022 terrazzo black
terrazzo black
- 0023 calacatta oro
golden calacatta
- 0025 bianco statuario
statuario white
- 0026 pietra grey
grey stone
- 0027 pulpis brown
pulpis brown
- 0028 nero marquinia
marquinia black
- 0024 calacatta oro lucido
glossy golden calacatta
- 0029 nero marquinia lucido
glossy marquinia black



Tavolo Circus con struttura centrale in tondino di acciaio cromato, colore ottone e piano in gres porcellanato, finitura marmo lucido, colore calacatta oro; misura diametro cm 160.
ft. sedie Waiya, poltroncina Waiya.p, lampada Can Can.

Circus table with central chrome-plated steel rod frame, brass colour and porcelain stoneware top, glossy marble finish, golden calacatta colour; diameter size cm 160.
ft. Waiya chairs, Waiya.p armchair, Can Can lamp.



Tavolo Circus con struttura centrale
in tondino di acciaio verniciato, colore
grigio piombo e piano in cristallo, finitura
trasparente; misura diametro cm 130.
Circus table with central painted steel
rod frame, lead grey colour and glass top,
transparent finish; diameter size cm 130.



Dettaglio, tavolo Circus con struttura centrale in tondino di acciaio cromato, colore ottone e piano in gres porcellanato, finitura marmo opaco, colore nero marquinia; misura diametro cm 120.

Detail, Circus table with central chrome-plated steel rod frame, brass colour and porcelain stoneware top, matt marble finish, marquinia black colour; diameter size cm 120.



Tavolo Circus con struttura centrale in tondino di acciaio verniciato, colore nero assoluto e piano in gres porcellanato, finitura marmo opaco, colore nero marquinia; misura diametro cm 160.

Circus table with central painted steel rod frame, absolute black colour and porcelain stoneware top, matt marble finish, marquinia black colour; diameter size cm 160.



Tavolo Circus con struttura centrale in tondino di acciaio verniciato, colore nero assoluto e piano in gres porcellanato, finitura marmo opaco, colore nero marquinia; misura diametro cm 160.

ft. sedie Jackie, lampade Can Can.

Circus table with central painted steel rod frame, absolute black colour and porcelain stoneware top, matt marble finish, marquinia black colour; diameter size cm 160.

ft. Jackie chairs, Can Can lamps.

V6

Design F. Di Martino

Tavolo con base in acciaio verniciato o cromato e struttura centrale in legno di frassino naturale o laccato. Il piano viene realizzato in cristallo o gres porcellanato ed è disponibile in varie misure, finiture e colori.

Table with painted or chrome-plated steel base and central frame in natural or lacquered ash wood. Its top is made of glass or porcelain stoneware and is available in different sizes, finishes and colours.

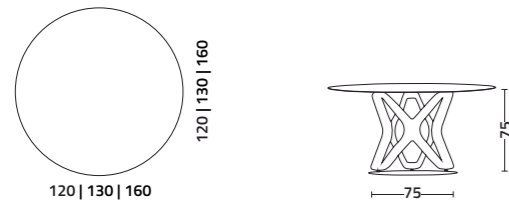

base - base
acciaio - steel

- 7022 grigio piombo
lead grey
- 9005 nero assoluto
absolute black
- 0076 cromo
chrome

struttura - frame
frassino - ash

- 0001 naturale
natural
- 0002 smoke
smoke
- 9005 nero assoluto
absolute black

piano - top
cristallo - glass

- 0001 trasparente
transparent
- 0063 fumé
smoke

piano - top
gres porcellanato
porcelain stoneware

- 7004 grigio cemento
cement grey
- 7024 grigio antracite
charcoal grey
- 0021 terrazzo grey
terrazzo grey
- 0022 terrazzo black
terrazzo black
- 0023 calacatta oro
golden calacatta
- 0025 bianco statuario
statuario white
- 0026 pietra grey
grey stone
- 0027 pulpis brown
pulpis brown
- 0028 nero marquinia
marquinia black
- 0024 calacatta oro lucido
glossy golden calacatta
- 0029 nero marquinia lucido
glossy marquinia black



Tavolo V6 con base in acciaio verniciato, colore grigio piombo e struttura centrale in legno di frassino laccato, colore nero assoluto; piano in gres porcellanato, finitura marmo opaco, colore nero marquinia; misura diametro cm 160.
ft. sedie Diana.f, lampada Can Can.

V6 table with painted steel base, lead grey colour and central lacquered ash wood frame, absolute black colour; porcelain stoneware top, matt marble finish, marquinia black colour; diameter size cm 160.
ft. Diana.f chairs, Can Can lamp.



Dettaglio, tavolo V6 con base in acciaio verniciato, colore grigio piombo e struttura centrale in legno di frassino, colore nero assoluto; piano in gres porcellanato, finitura marmo lucido, colore calacatta oro; misura diametro cm 160.

Detail, V6 table with painted steel base, lead grey colour and central lacquered ash wood frame, absolute black colour; porcelain stoneware top, glossy marble finish, golden calacatta colour; diameter size cm 160.



Tavolo V6 con base in acciaio verniciato, colore grigio piombo e struttura centrale in legno di frassino laccato, colore nero assoluto; piano in cristallo, finitura trasparente; diametro misura cm 130.

V6 table with painted steel base, lead grey colour and central lacquered ash wood frame, absolute black colour; glass top, transparent finish; diameter size cm 130.

Tavolo V6 con base in acciaio verniciato, colore nero assoluto e struttura centrale in legno di frassino laccato, nello stesso colore; piano in gres porcellanato, finitura marmo lucido, colore nero marquinia; misura diametro cm 160.

ft sedia Grace, poltroncina Grace.p.

V6 table with painted steel base, absolute black colour and central lacquered ash wood frame, in the same colour; porcelain stoneware top, glossy marble finish, marquinia black colour; diameter size cm 160.

ft. Grace chair, Grace.p armchair.



Cargo

Design RobertoPamio+Partners

Tavolo con base in legno di rovere naturale o laccato; il piano viene realizzato in legno di rovere naturale o laccato o gres porcellanato ed è disponibile in varie misure, finiture e colori. Nella versione allungabile, il telaio in alluminio ha apertura telescopica con allunghe in legno di rovere naturale o laccato, in tinta con la struttura.

Table with natural or lacquered oak wood frame; its top is made of natural or lacquered oak wood or porcelain stoneware and is available in different sizes, finishes and colours. In its extendable version, the aluminium framework has a telescopic mechanism with natural or lacquered oak wood extensions, to match the frame.

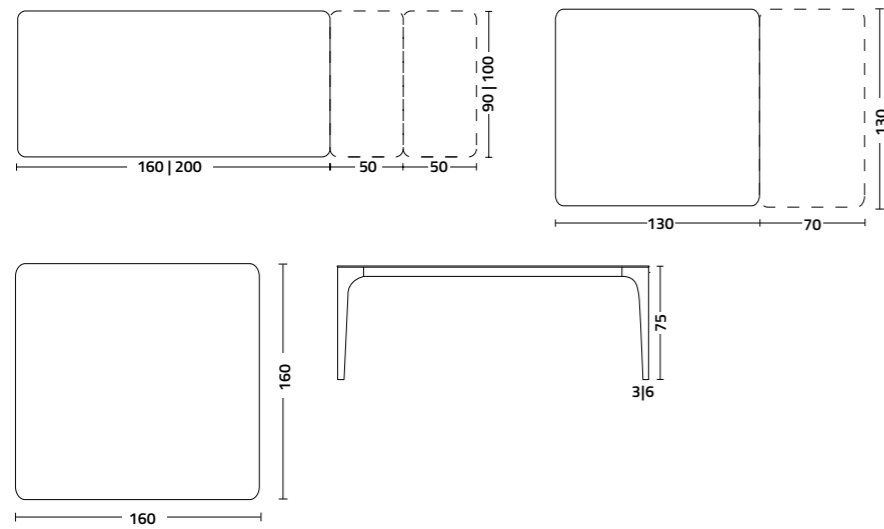

struttura - frame
allunghe - extensions
rovere - oak

- 0001 naturale natural
- 0002 smoke smoke
- 9005 nero assoluto absolute black

piano - top
rovere - oak

- 0001 naturale natural
- 0002 smoke smoke
- 9005 nero assoluto absolute black

piano - top
gres porcellanato
porcelain stoneware

- 7004 grigio cemento cement grey
- 7024 grigio antracite charcoal grey
- 0021 terrazzo grey terrazzo grey
- 0022 terrazzo black terrazzo black
- 0023 calacatta oro golden calacatta
- 0025 bianco statuario statuario white
- 0026 pietra grey grey stone
- 0027 pulpis brown pulpis brown
- 0028 nero marquinia marquinia black
- 0024 calacatta oro lucido glossy golden calacatta
- 0029 nero marquinia lucido glossy marquinia black



Tavolo Cargo con struttura in legno di rovere naturale e piano in gres porcellanato, finitura marmo opaco, colore calacatta oro; versione allungabile, misura cm 160x90 con due allunghe in legno di rovere naturale, cm 50 cadauna. ft. sedie Dandy.

Cargo table with natural oak wood frame and porcelain stoneware top, matt marble finish, golden calacatta colour; extendable version, size cm 160x90 with two natural oak wood extensions, cm 50 each. ft. Dandy chairs.





Tavolo Cargo con struttura e piano in legno di rovere naturale.
Versione allungabile misura cm 160x90 con due allunghe in
legno di rovere naturale, cm 50 cada una.
ft. sedie Rap.w

Cargo table with natural oak wood frame and top,
extendable version, size cm 160x90 with two
natural oak wood extensions, cm 50 each.
ft. Rap.w chairs.

Tavolo Cargo con struttura in legno di rovere laccato, colore nero assoluto e piano in gres porcellanato, finitura marmo opaco, colore nero marquinia; versione allungabile, misura cm 130x130 con una allunga in legno di rovere laccato, colore nero assoluto, cm 70. ft. sedie Giò, lampada Can Can.

On these pages:
Cargo table with lacquered oak wood frame, absolute black colour and porcelain stoneware top, matt marble finish, marquinia black colour; extendable version, size cm 130x130 with one lacquered oak wood extension, absolute black colour, cm 70. ft. Giò chairs, Can Can lamp.



Tavolo Cargo con struttura in legno di rovere laccato smoke e piano gres porcellanato, finitura marmo opaco, colore pulpis brown; versione allungabile, misura cm 200x100, con due allunghe in legno di rovere laccato smoke, cm 50 cadauna.
ft. poltroncine Odyssée.m.

Cargo table with smoke lacquered oak wood frame and porcelain stoneware top, matt marble finish, pulpis brown colour; extendable version, size cm 200x100 with two smoke lacquered oak wood extensions, cm 50 each.
ft. Odyssée.m armchairs.



Slash

Design G. Azzarello

Tavolo allungabile, con telaio in alluminio ad apertura telescopica, interamente realizzato in legno di rovere nodato naturale e disponibile in varie misure.

Extendable table, with aluminium framework and telescopic mechanism, entirely made of natural raw oak wood and available in different sizes.

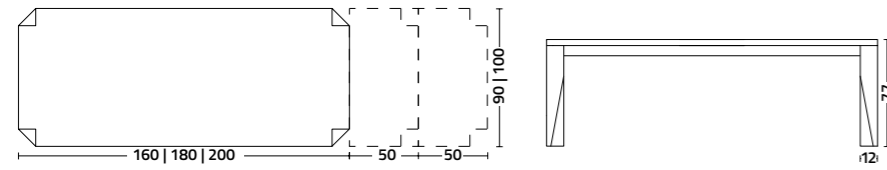

rovere - oak

5001 naturale nodato
raw natural



Dettaglio, tavolo Slash in legno di rovere nodato naturale, gamba in legno massello.
Detail, Slash table in natural raw oak wood, solid wood leg.



Tavolo Slash in legno di rovere nodato naturale;
misura cm 200x100, con due allunghe
da cm 50 cadauna.
ft. sedie Rap Wood.

Slash table in natural raw oak wood;
size cm 200x100, with two
extensions, cm 50 each.
ft. Rap Wood chairs.





Tavolo Slash in legno di rovere nodato naturale;
misura cm 200x100, con due allunghe
da cm 50 cadauna.
ft. sedie Milano2015.

Slash table in natural raw oak wood;
size cm 200x100, with two extensions,
cm 50 each.
ft. Milano2015 chairs.

Skin

Design G. Azzarello

Tavolo con struttura e piano in lamiera di acciaio verniciata con rovere nodato naturale.

Table with painted steel sheet and natural raw oak wood frame and top.

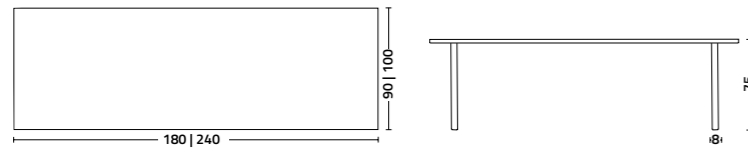

lamiera di acciaio - steel sheet

rovere - oak

9004 nero ferro
iron black

5001 naturale nodato
raw natural



Dettaglio, tavolo Skin con struttura e piano in lamiera di acciaio verniciata, colore nero ferro e legno di rovere nodato naturale; misura cm 240x100.
Detail, Skin table with painted steel sheet, iron black colour and natural raw oak wood frame and top; size cm 240x100.

Tavolo Skin con struttura e piano in lamiera di acciaio verniciata, colore nero ferro e legno di rovere nodato naturale; misura cm 240x100. ft. sedie Rap Wood.

Skin table with painted steel sheet, iron black colour and natural raw oak wood frame and top; size cm 240x100. ft. Rap Wood chairs.



Oste

Design W. Colico

Tavolo interamente realizzato in metacrilato trasparente, disponibile in varie misure.

Table entirely made of transparent methacrylate, available in different sizes.

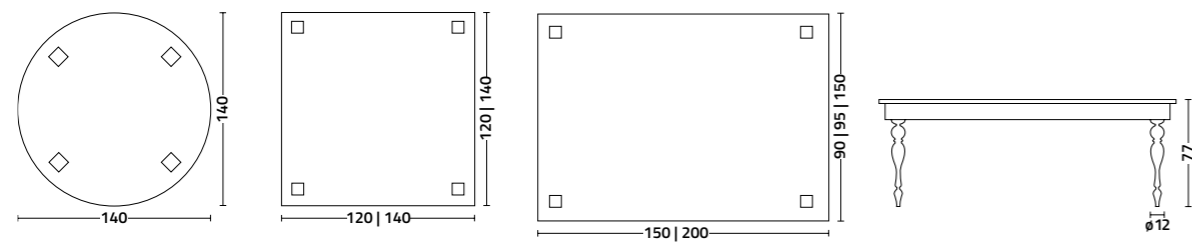

metacrilato - methacrylate

0001 trasparente
transparent



Tavolo Oste, con struttura e piano in metacrilato trasparente; misura cm 200x95.
ft. sedie Brera.

Oste table in transparent methacrylate;
size cm 200x95.
ft. Brera chairs.



Scatto frontale e dettaglio, tavolo Oste in metacrilato trasparente; misura diametro cm 140.
ft. sedie Grace.
Front shoot and detail, Oste table in transparent methacrylate; diameter size cm 140.
ft. Grace chairs.

Level

Design CR&S Colico

Tavolo allungabile con telaio e struttura in alluminio verniciato ad apertura telescopica, con allunghe in laminato; il piano viene realizzato in laminato, cristallo o gres porcellanato ed è disponibile in varie misure, finiture e colori.

Extendable table with painted aluminium frame and framework, telescopic mechanism, and laminate extensions; its top is made of laminate, glass or porcelain stoneware and is available in different sizes, finishes and colours.

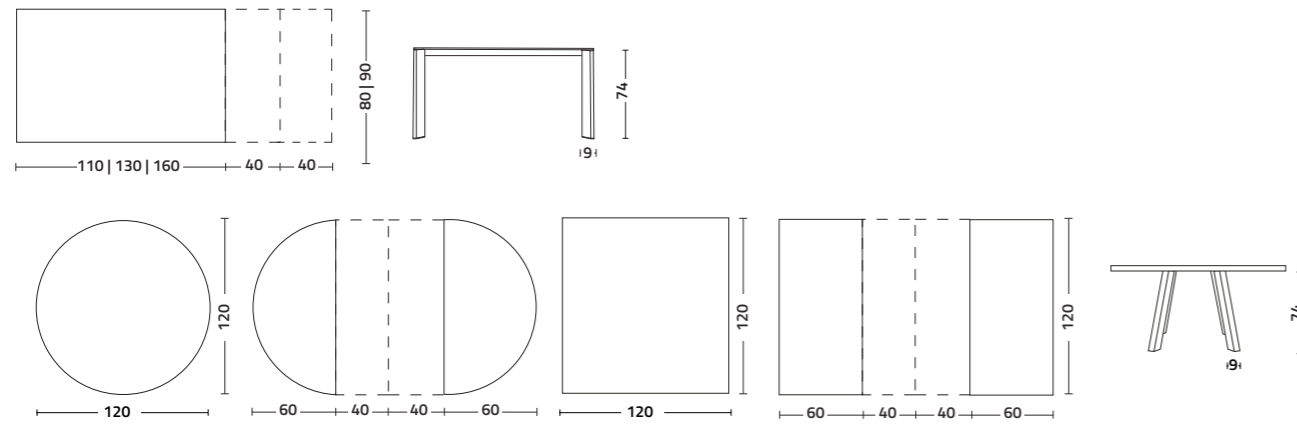

struttura - frame alluminio - aluminium

- 9003 bianco zucchero sugar white
- 7024 grigio antracite charcoal grey
- 9005 nero assoluto absolute black

allunghe - extensions laminato - laminate

- 9003 bianco zucchero sugar white
- 7024 grigio antracite charcoal grey

piano - top laminato - laminate

- 9003 bianco zucchero sugar white
- 7024 grigio antracite charcoal grey

piano - top cristallo opaco - matt glass

- 9003 bianco zucchero sugar white
- 7024 grigio antracite charcoal grey
- 9005 nero assoluto absolute black

piano - top gres porcellanato porcelain stoneware

- 7004 grigio cemento cement grey
- 7024 grigio antracite charcoal grey
- 0021 terrazzo grey terrazzo grey
- 0022 terrazzo black terrazzo black
- 0023 calacatta oro golden calacatta
- 0025 bianco statuario statuario white
- 0026 pietra grey grey stone
- 0027 pulpis brown pulpis brown
- 0028 nero marquinia marquinia black



Dettaglio piano, tavolo Level in gres porcellanato, finitura pietra, colore grigio antracite.

Top detail, Level table in porcelain stoneware, stone finish, charcoal grey colour.

Tavolo Level con struttura in alluminio verniciato, colore grigio antracite e piano in gres porcellanato, finitura pietra, colore grigio antracite; misura cm 130x80 con due allunghe in laminato, colore grigio antracite, da cm 40 cadauna.
ft. sedie Rapper, Dandy Iron.

Level table with painted aluminium frame, charcoal grey colour and porcelain stoneware top, stone finish, charcoal grey colour; size cm 130x80 with two laminate extensions, charcoal grey colour, cm 40 each.
ft. Rapper, Dandy Iron chairs.





Tavolo Level con struttura in alluminio verniciato, colore grigio antracite e piano in gres porcellanato, finitura marmo opaco, colore pietra grey; misura cm 130x80 con due allunghe in laminato, colore grigio antracite, da cm 40 ciascuna.

Level table with painted aluminium frame, charcoal grey colour and porcelain stoneware top, matt marble finish, grey stone colour; size cm 130x80 with two laminate extensions, charcoal grey colour, cm 40 each.



Tavolo Level con struttura in alluminio verniciato, colore nero assoluto e piano in gres porcellanato, finitura pietra, colore terrazzo black; misura diametro cm 120 con due allunghe in laminato, colore grigio antracite, da cm 40 cadauna.
ft. sedie Rap.tt.

Level table with painted aluminium frame, absolute black colour and porcelain stoneware top, stone finish, terrazzo black colour; diameter size cm 120 with two laminate extensions, charcoal grey colour, cm 40 each.
ft. Rap.tt chairs.



Tavolo Level con struttura in alluminio verniciato, colore nero assoluto e piano in gres porcellanato, finitura marmo opaco, colore nero marquinia; misura cm 120x120 con due allunghe in laminato, colore grigio antracite, da cm 40 cadauna.

Level table with painted aluminium frame, absolute black colour and porcelain stoneware top, matt marble finish, marquinia black colour; size cm 120x120 with two laminate extensions, charcoal grey colour, cm 40 each.

Tavolo Level con struttura in alluminio verniciato, colore nero assoluto e piano in gres porcellanato, finitura pietra, colore terrazzo black; misura diametro cm 120 con due allunghe in laminato, colore grigio antracite, da cm 40 cadauna.

Level table with painted aluminium frame, absolute black colour and porcelain stoneware top, stone finish, terrazzo black colour; diameter size cm 120 with two laminate extensions, charcoal grey colour, cm 40 each.



Pure

Design We & Co.

Tavolo con struttura in alluminio e piano in lamiera di acciaio verniciati con anima in poliestere, disponibile in diverse misure e colori ed adatto ad uso esterno. Disponibile versione in resina spatolata a mano, adatta ad uso interno.

Table with painted aluminium frame and steel sheet top with polyester core, available in different sizes and colours and suitable for outdoor. Hand-brushed resin finish also available for indoor.

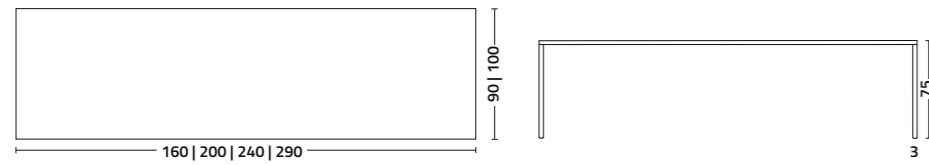

alluminio - aluminium
lamiera di acciaio - steel sheet
vernici - paints

- 9003 bianco zucchero
sugar white
- 9005 nero assoluto
absolute black

resine - resins

- 7004 grigio cemento
cement grey
- 7024 grigio antracite
charcoal grey



Tavolo Pure con struttura in alluminio e piano in lamiera verniciati, colore nero assoluto; misura cm 200x100. ft. poltroncine Odyssee.

Pure table with painted aluminium frame and steel sheet top, absolute black colour; size cm 200x100. ft. Odyssee armchairs.

Tavolo Pure con struttura in alluminio e piano in lamiera di acciaio, finitura resina, colore grigio cemento; misura cm 290x100. ft. sedie Gol.

Pure table with aluminium frame and steel sheet top, resin finish, cement grey colour; size cm 290x100. ft. Gol chairs.





Tavolo Pure con struttura in alluminio e piano in lamiera di acciaio verniciati, colore nero assoluto; misura cm 200x100. ft. sedie Go!

Pure table with painted aluminium frame and steel sheet top, absolute black colour; size cm 200x100. ft. Go! chairs.



Dettaglio, tavolo Pure con struttura in alluminio e piano in lamiera di acciaio, finitura resina, colore grigio cemento; misura cm 290x100.

Detail, Pure table with aluminium frame and steel sheet top, resin finish, cement grey colour; size cm 290x100.

Piet

Design Chiamonte Marin

Tavolo allungabile con struttura in acciaio verniciato e telaio in alluminio ad apertura telescopica; piano in lamiera di acciaio verniciata con taglio laser decorativo.
Disponibile versione adatta ad uso esterno.

Extendable table with painted steel frame and aluminium framework, telescopic mechanism; painted steel sheet top with decorative laser cut.
Outdoor version also available.

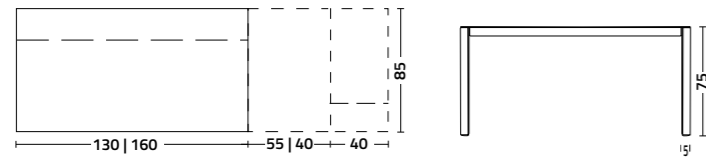

lamiera di acciaio - steel sheet

- 9003 bianco zucchero
sugar white
- 9005 nero assoluto
absolute black



Dettaglio, tavolo Piet con struttura in acciaio verniciato, colore nero assoluto e piano in lamiera di acciaio verniciata, nello stesso colore.
Detail, Piet table with painted steel frame, absolute black colour and painted steel sheet top, in the same colour.



Tavolo Piet con struttura in acciaio verniciato, colore nero assoluto e piano in lamiera di acciaio verniciata, nello stesso colore; misura cm 160x85 con due allunghe, una da cm 55 e l'altra da cm 40.

ft. sedie Rap.tt, lampade Can Can.

Piet table with painted steel frame, absolute black colour and painted steel sheet top, in the same colour; size cm 160x85 with two extensions, one of cm 55 the other one of cm 40.

ft. Rap.tt chairs, Can Can lamps.



Star

Design Fauciglietti Engineering

Tavolo con struttura centrale in tondino di acciaio verniciato o cromato. Il piano viene realizzato in laminato, lamiera di acciaio verniciata o gres porcellanato ed è disponibile in varie misure, finiture e colori.

Table with central frame in painted or chrome-plated steel rod. Its top is made of laminate, painted steel sheet or porcelain stoneware and is available in different sizes, finishes and colours.

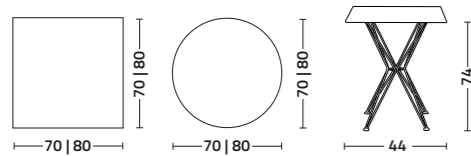

struttura - frame
tondino di acciaio - steel rod

- 7022 grigio piombo
lead grey
- 9005 nero assoluto
absolute black
- 0076 cromo ottone
brass chrome
- 0074 cromo rame
copper chrome

piano - top
laminato - laminate

- 9003 bianco zucchero
sugar white
- 7024 grigio antracite
charcoal grey

piano - top
lamiera di acciaio - steel sheet

- 9005 nero assoluto
absolute black

piano - top
gres porcellanato
porcelain stoneware

- 7004 grigio cemento
cement grey
- 7024 grigio antracite
charcoal grey
- 0021 terrazzo grey
terrazzo grey
- 0022 terrazzo black
terrazzo black
- 0023 calacatta oro
golden calacatta
- 0025 bianco statuario
statuario white
- 0026 pietra grey
grey stone
- 0027 pulpis brown
pulpis brown
- 0028 nero marquinia
marquinia black
- 0024 calacatta oro lucido
glossy golden calacatta
- 0029 nero marquinia lucido
glossy marquinia black



Dettaglio, tavolo Star con struttura centrale in tondino di acciaio verniciato, colore grigio piombo e piano in gres porcellanato, finitura marmo opaco, colore nero marquinia; misura cm 80x80.
ft. sedia Rap.tt.

Detail, Star table with central painted steel rod frame, lead grey colour and porcelain stoneware top, matt marble finish, marquinia black colour; size cm 80x80.
ft. Rap.tt chair.





Tavolo Star con struttura centrale in tondino di acciaio cromato, colore rame e piano in gres porcellanato, finitura marmo lucido, colore calacatta oro; misura diametro cm 80. ft. poltroncine Waiya.p.
Star table with central chrome-plated steel rod frame, copper colour and porcelain stoneware top, glossy marble finish, golden calacatta colour; diameter size cm 80. ft. Waiya.p armchairs.

Tavolo Star con struttura centrale in tondino di acciaio cromato, colore ottone e piano in gres porcellanato, finitura marmo opaco, colore nero marquinia; misura cm 80x80.
ft. sedie Wayia.

Star table with central chrome-plated steel rod frame, brass colour and porcelain stoneware top, matt marble finish, marquinia black colour; size cm 80x80.
ft. Waiya chairs.



Acqua Alta bistrot

Design studio14

Tavoli con struttura centrale in acciaio verniciato o acciaio verniciato con legno di rovere; il piano viene realizzato in laminato, lamiera di acciaio verniciata o gres porcellanato ed è disponibile in varie misure, finiture e colori.

Tables with central frame in painted steel or painted steel with oak wood; its top is made of laminate, painted steel sheet or porcelain stoneware and is available in different sizes, finishes and colours.

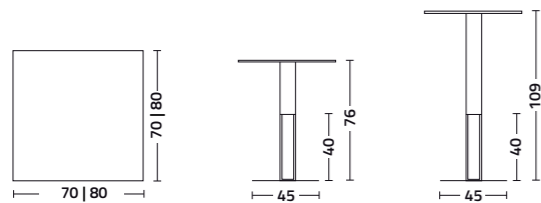

struttura - frame
acciaio - steel

9005 nero assoluto
absolute black

struttura - frame
rovere - oak

5001 naturale nodato
raw natural

piano - top
laminato - laminate

9003 bianco zucchero
sugar white

7024 grigio antracite
charcoal grey

piano - top
lamiera di acciaio - steel sheet

9005 nero assoluto
absolute black

piano - top
gres porcellanato
porcelain stoneware

7004 grigio cemento
cement grey

7024 grigio antracite
charcoal grey

0021 terrazzo grey
terrazzo grey

0022 terrazzo black
terrazzo black

0023 calacatta oro
golden calacatta

0025 bianco statuario
statuario white

0026 pietra grey
grey stone

0027 pulpis brown
pulpis brown

0028 nero marquinia
marquinia black

0024 calacatta oro lucido
glossy golden calacatta

0029 nero marquinia lucido
glossy marquinia black



Tavolo Acqua Alta Bistrot Iron con struttura centrale alta cm 109 in acciaio verniciato, colore nero assoluto e piano in lamiera di acciaio verniciata, nello stesso colore; misura cm 70x70.
ft. sgabello Rap Wood.ss.

Acqua Alta Bistrot Iron table with central painted steel frame cm 109 height, absolute black colour and painted steel sheet top, in the same colour; size cm 70x70.
ft. Rap Wood.ss stool.





Tavolo Acqua Alta Bistrot con struttura centrale in acciaio verniciato, colore nero assoluto con rovere nodato naturale e piano in lamiera di acciaio verniciata, nello stesso colore; misura cm 70x70.

Acqua Alta Bistrot table with central painted steel frame absolute black colour with natural raw oak wood and painted steel sheet top, in the same colour; size cm 70x70.

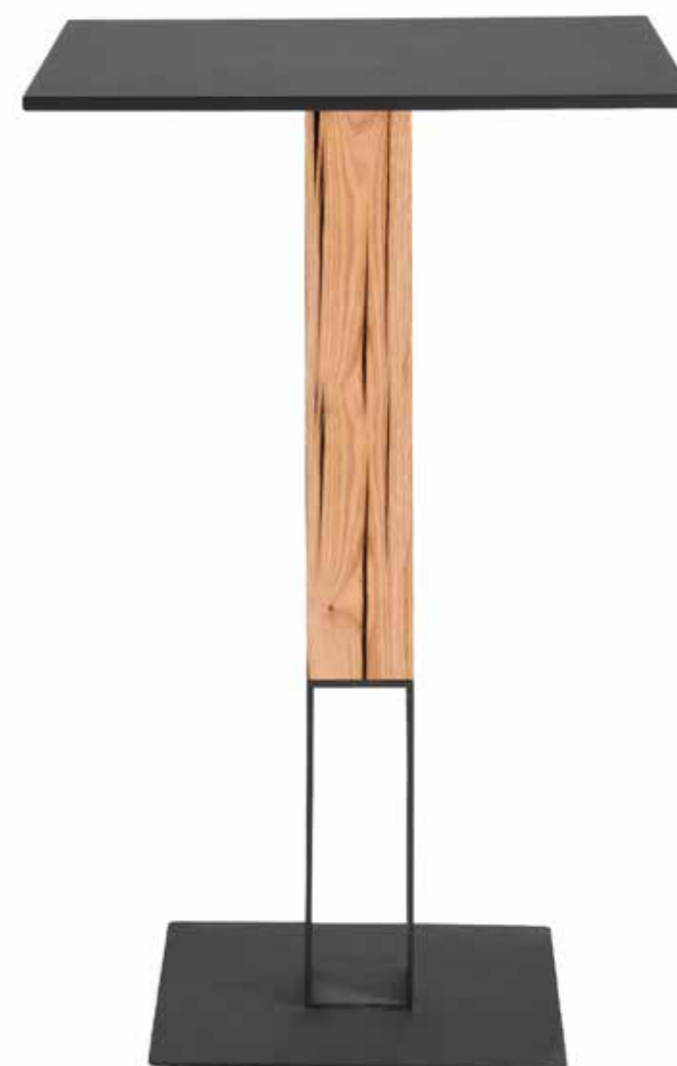

Tavolo Acqua Alta Bistrot Iron con struttura centrale alta cm 76 in acciaio verniciato, colore nero assoluto e piano in lamiera di acciaio verniciata, nello stesso colore; misura cm 80x80.
Acqua Alta Bistrot Iron table with central painted steel frame cm 76 height, absolute black colour and painted steel sheet top, in the same colour; size cm 80x80.



Teorico

Design E. Palmisciano

Tavolo con struttura centrale in acciaio verniciato; il piano viene realizzato in cristallo o gres porcellanato ed è disponibile in varie finiture e colori.

Table with central frame in painted steel; its top is made of glass or porcelain stoneware and is available in different finishes and colours.

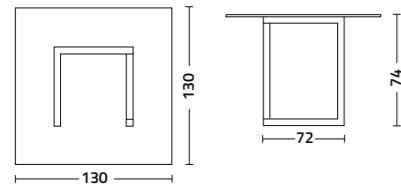

struttura - frame
acciaio - steel

- 9003 bianco zucchero
sugar white
- 7032 beige champagne
champagne beige
- 7022 grigio piombo
lead grey
- 9005 nero assoluto
absolute black

piano - top
cristallo - glass

- 0001 trasparente
transparent
- 0063 fumé
smoke

piano - top
gres porcellanato
porcelain stoneware

- 7004 grigio cemento
cement grey
- 7024 grigio antracite
charcoal grey
- 0021 terrazzo grey
terrazzo grey
- 0022 terrazzo black
terrazzo black
- 0023 calacatta oro
golden calacatta
- 0025 bianco statuario
statuario white
- 0026 pietra grey
grey stone
- 0027 pulpis brown
pulpis brown
- 0028 nero marquinia
marquinia black
- 0024 calacatta oro lucido
glossy golden calacatta
- 0029 nero marquinia lucido
glossy marquinia black



Tavolo Teorico con struttura centrale in acciaio verniciato, colore grigio piombo e piano in cristallo, finitura trasparente.
Teorico table with central painted steel frame, lead grey colour and glass top, transparent finish.



Tavolo Teorico con struttura centrale in acciaio verniciato, colore nero assoluto e piano in cristallo, finitura trasparente. ft. sedie Giò.

Teorico table with central painted steel frame, absolute black colour and glass top, transparent finish. ft. Giò chairs.



living

Can Can

Design Studio14

Collezione di lampade con paralume in tondino di acciaio cromato o verniciato, disponibili in forme diverse ed utilizzabili a sospensione o da terra.

Collection of lamps with chrome-plated or painted steel rod lampshade, available in different shapes and usable as pendant or floor lamps.

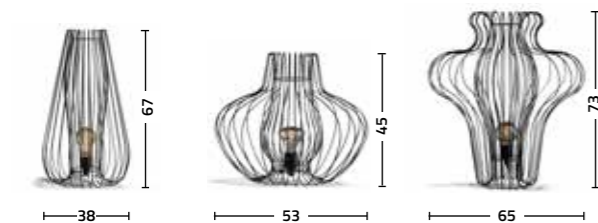

tondino di acciaio - steel rod

- 9003 bianco zucchero
sugar white
- 7022 grigio piombo
lead grey
- 9005 nero assoluto
absolute black
- 0076 cromo ottone
brass chrome
- 0074 cromo rame
copper chrome

Da sinistra:
Lampade a sospensione Can Can, modelli B e A,
in tondino di acciaio cromato, colore rame.

From the left:
Can Can pendant lamps, B and A models, in
chrome-plated steel rod, copper colour.
ft. sedie Jackie, tavolo Circus.



Lampada a sospensione Can Can, modello C,
in tondino di acciaio cromato, colore ottone.
ft. poltroncine Waiya.p, tavolo Circus.
Can Can pendant lamp, C model, in
chrome-plated steel rod, brass colour.
ft. Waiya.p armchairs, Circus table.



Lampada a sospensione Can Can, modello A,
in tondino di acciaio verniciato,
colore grigio piombo.
ft. sedie Rap.tt, tavolo Level.
Can Can pendant lamp, A model,
in painted steel rod, lead grey colour.
ft. Rap.tt chairs, Level table.



Lampada da terra Can Can, modello A,
in tondino di acciaio verniciato, colore
grigio piombo.
Can Can floor lamp, A model, in painted
steel rod, lead grey colour.



Lampada da terra Can Can, modello B,
in tondino di acciaio verniciato, colore
nero assoluto.
Can Can floor lamp, B model, in painted steel
rod, absolute black colour.



Da sinistra:
Lampade da terra Can Can, modello A B e C,
in tondino di acciaio verniciato, colore
grigio piombo.

ft. divano Asami Iron.

From the left:
Can Can floor lamps, A B and C models,
in painted steel rod, lead grey colour.
ft. Asami Iron sofa.



Asami

Design M. Guerini, M. Vernocchi

Divano componibile con struttura in metacrilato e cuscini seduta e schienale imbottiti e rivestiti in tessuto, ecopelle o pelle. Versione adatta ad uso esterno, su richiesta.

Modular sofa with methacrylate frame, seat and back cushions padded and upholstered with fabric, artificial leather or real leather. Outdoor version, on request.

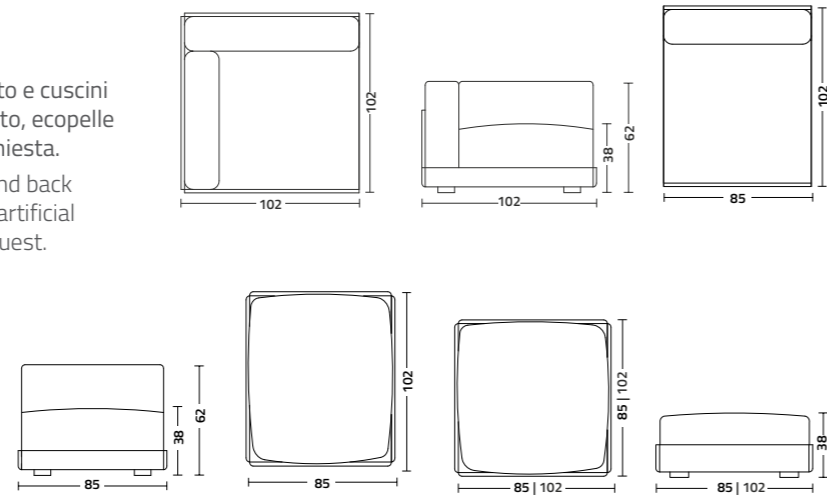

struttura - frame metacrilato - methacrylate

- 0001 trasparente
transparent
- 0050 vetro metacrilato
methacrylate glass

rivestimento - upholstery tessuto - fabric vivido

- 03 grigio tortora
taupe grey
- 59 rosa pastello
pastel pink
- 57 rosso borgogna
burgundy red
- 42 verde marino
marine green
- 05 grigio antracite
charcoal grey
- 32 nero assoluto
absolute black

rivestimento - upholstery tessuto - fabric magico

- 01 bianco avorio
ivory white
- 11 giallo senape
mustard yellow
- 03 beige avana
fallow beige
- 02 beige canapa
hemp beige
- 04 marrone glacé
glacé brown
- 05 grigio silver
silver grey
- 06 grigio ardesia
slate grey

rivestimento - upholstery tessuto - fabric fiocco

- 0206 beige canapa
hemp beige
- 8008 rosa corallo
coral pink
- 9260 arancione ruggine
rust orange
- 3103 rosso scarlatto
scarlet red
- 6714 verde mirto
brunswick green
- 5667 verde ottanio
teal green
- 5554 viola indaco
indigo violet
- 4765 marrone glacé
glacé brown
- 0408 grigio antracite
charcoal grey
- 0802 nero assoluto
absolute black

rivestimento - upholstery ecopelle - artificial leather magnum

- 102 bianco zucchero
sugar white
- 118 beige tortora
taupe beige
- 113 grigio fango
taupe grey
- 129 rosso scarlatto
scarlet red
- 110 marrone caffè
coffee brown
- 126 grigio silver
silver grey
- 120 grigio antracite
charcoal grey
- 101 nero assoluto
absolute black

rivestimento - upholstery ecopelle - artificial leather vintage

- 004 marrone noce
walnut brown
- 007 marrone glacé
glacé brown
- 002 grigio antracite
charcoal grey
- 001 nero assoluto
absolute black

rivestimento - upholstery ecopelle - artificial leather econabuk

- 79 giallo senape
mustard yellow
- 29 rosso rubino
ruby red
- 60 verde menta
mint green
- 15 grigio perla
pearl grey
- 44 grigio antracite
charcoal grey
- 13 nero assoluto
absolute black

rivestimento - upholstery pelle - leather alysée

- 0010 bianco zucchero
sugar white
- 0090 beige avana
sand beige
- 1514 giallo senape
mustard yellow
- 0050 rosso rubino
ruby red
- 1532 rosso borgogna
burgundy red
- 1518 marrone bruno
umber brown
- 1524 grigio antracite
charcoal grey
- 0040 nero assoluto
absolute black



Divano componibile Asami, quattro posti con pouf, struttura in metacrilato, finitura trasparente; cuscini seduta e schienale imbottiti e rivestiti in tessuto cliente.

Asami modular sofa, four-seater with poufs, methacrylate frame, transparent finish; seat and back cushions padded and upholstered with client's fabric.

Divano componibile Asami, quattro posti con pouf, struttura in metacrilato, finitura trasparente; cuscini seduta e schienale imbottiti e rivestiti in tessuto, Magico, colori bianco avorio e grigio ardesia.

Asami modular sofa, four-seater with poufs, methacrylate frame, transparent finish; seat and back cushions padded and upholstered with fabric, Magico, ivory white and slate grey colours.



Asami Iron

Design M. Guerini, M. Vernocchi

Divano componibile con struttura in lamiera di acciaio verniciata e cuscini seduta e schienale imbottiti e rivestiti in tessuto, ecopelle o pelle. Versione adatta ad uso esterno, su richiesta.

Modular sofa with painted steel sheet frame, seat and back cushions padded and upholstered with fabric, artificial leather or real leather. Outdoor version, on request.

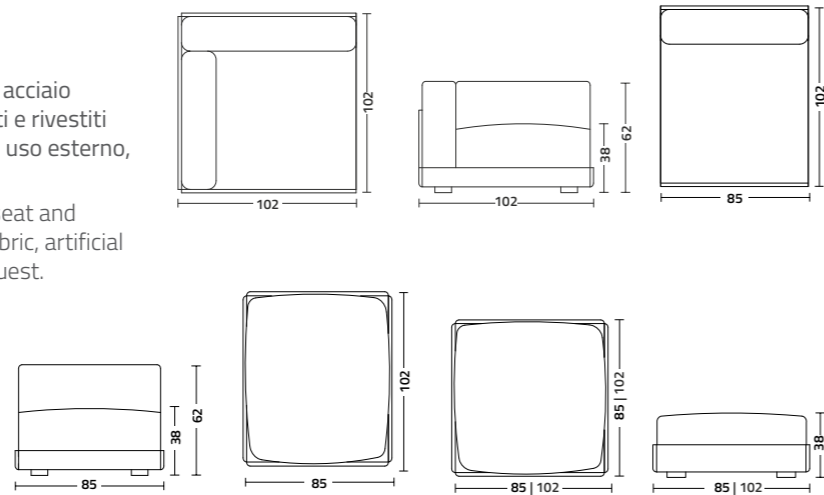

struttura - frame lamiera di acciaio - steel sheet

- 9003 bianco zucchero
sugar white
- 9005 nero assoluto
absolute black

rivestimento - upholstery tessuto - fabric vivido

- 03 grigio tortora
taupe grey
- 59 rosa pastello
pastel pink
- 57 rosso borgogna
burgundy red
- 42 verde marino
marine green
- 05 grigio antracite
charcoal grey
- 32 nero assoluto
absolute black

rivestimento - upholstery tessuto - fabric magico

- 01 bianco avorio
ivory white
- 11 giallo senape
mustard yellow
- 03 beige avana
fallow beige
- 02 beige canapa
hemp beige
- 04 marrone glacé
glacé brown
- 05 grigio silver
silver grey
- 06 grigio ardesia
slate grey

rivestimento - upholstery tessuto - fabric fiocco

- 0206 beige canapa
hemp beige
- 8008 rosa corallo
coral pink
- 9260 arancione ruggine
rust orange
- 3103 rosso scarlatto
scarlet red
- 6714 verde mirto
brunswick green
- 5667 verde ottanio
teal green
- 5554 viola indaco
indigo violet
- 4765 marrone glacé
glacé brown
- 0408 grigio antracite
charcoal grey
- 0802 nero assoluto
absolute black

rivestimento - upholstery ecopelle - artificial leather magnum

- 102 bianco zucchero
sugar white
- 118 beige tortora
taupe beige
- 113 grigio fango
taupe grey
- 129 rosso scarlatto
scarlet red
- 110 marrone caffè
coffee brown
- 126 grigio silver
silver grey
- 120 grigio antracite
charcoal grey
- 101 nero assoluto
absolute black

rivestimento - upholstery ecopelle - artificial leather vintage

- 004 marrone noce
walnut brown
- 007 marrone glacé
glacé brown
- 002 grigio antracite
charcoal grey
- 001 nero assoluto
absolute black

rivestimento - upholstery ecopelle - artificial leather econabuk

- 79 giallo senape
mustard yellow
- 29 rosso rubino
ruby red
- 60 verde menta
mint green
- 15 grigio perla
pearl grey
- 44 grigio antracite
charcoal grey
- 13 nero assoluto
absolute black

rivestimento - upholstery pelle - leather alysée

- 0010 bianco zucchero
sugar white
- 0090 beige avana
sand beige
- 1514 giallo senape
mustard yellow
- 0050 rosso rubino
ruby red
- 1532 rosso borgogna
burgundy red
- 1518 marrone bruno
umber brown
- 1524 grigio antracite
charcoal grey
- 0040 nero assoluto
absolute black



Divano componibile Asami Iron, due posti, con struttura in lamiera di acciaio verniciata, colore bianco zucchero; cuscini seduta e schienale imbottiti e rivestiti in tessuto cliente. Asami Iron modular sofa, two-seater, with painted steel sheet frame, sugar white colour; seat and back cushions padded and upholstered with client's fabric.

Divano Asami Iron, tre posti, con struttura in lamiera di acciaio verniciata, colore nero assoluto; cuscini seduta e schienale imbottiti e rivestiti in tessuto cliente.

Asami Iron modular sofa, three-seater, with painted steel sheet frame, absolute black colour; seat and back cushions padded and upholstered with client's fabric.



Divano componibile Asami Iron, due posti,
con struttura in lamiera di acciaio verniciata,
colore bianco zucchero; cuscini seduta e
schienale imbottiti e rivestiti in tessuto cliente.

Asami Iron modular sofa, two-seater,
with painted steel sheet frame,
sugar white colour; seat and
back cushions padded and
upholstered with client's fabric.



AD & Graphic: **Overdrive**

Photo: **Matteo Imbriani**

Printed in Italy 06.2019

©2019, **Colico Design**

Tutti i diritti riservati.

Nessuna parte del presente catalogo può essere riprodotta o diffusa con un mezzo qualsiasi, fotocopie, microfilm o altro, senza il permesso del titolare del copyright.

All rights reserved.

No part of this catalogue can be reproduced or spread by any means, photocopying, microfilm or others, without the copyright holder's permission.

Nella stampa su carta la tonalità dei colori dei vari materiali, non può essere riprodotta fedelmente. Pertanto deve considerarsi indicativa e non potrà costituire motivo di contestazione o di resa del prodotto.

When printing on paper, the shades of the colours of various materials cannot be faithfully reproduced. Therefore must only be considered indicative and cannot constitute a motive for dispute or for the return of the product.

colico

extra ordinary design

Via Torino, 22 Varedo (MB)

Tel. +39 0362 582094

Fax +39 0362 544484

info@colico.com

www.colico.com