



LUXURY CRAFTED IN VERONA

THE PRODUCTS

1
VOLUME



ZB
Bruno Zampa
LUXURY CRAFTED IN VERONA

INDEX

VOL. 01

INTRODUCTION	4
---------------------	---

SOFAS, ARMCHAIRS & COMPLEMENTS

SOFAS	20
ARMCHAIRS	96
DORMEUSE	146
POUFS	156
SOFA TABLES	164

TABLES & DINING CHAIRS

DINING TABLES	206
DINING CHAIRS	248
BAR COUNTERS AND STOOLS	274

SUMMARY	284
----------------	-----

VOL. 02

INTRODUCTION	4
---------------------	---

BEDS & COMPLEMENTS

BEDS	20
BEDSIDE TABLES	50
CHEST OF DRAWERS	64
DRESSING TABLES	76
BENCHES	88

CABINETS

CONSOLLES	98
SIDEBOARDS	120
TV UNITS	140
DISPLAY CABINETS	160
BOOKSHELVES	174
CABINETS	184

OFFICE

DESKS	214
OFFICE CHAIRS	222

OCCASIONALS & DECORATIONS

MIRRORS	230
DECORATIONS	244
RUGS	256
LIGHTINGS	266

SUMMARY	280
----------------	-----

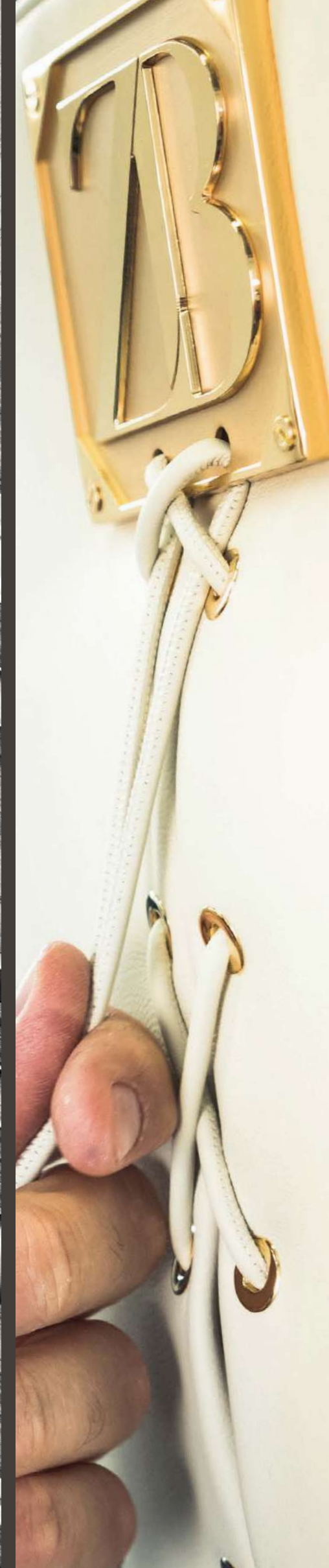

LUXURY CRAFTED IN VERONA

Luxury is crafted. Not made.
Luxury crafted by artisans is the most precious.
Artisans are not all the same.
That's why our craftsmanship is based exclusively in Verona.
To thrive on the heritage of Verona's art and lifestyle.

Il lusso è arte manuale. Non è semplicemente prodotto.
Il lusso realizzato dagli artigiani è il più prezioso.
Gli artigiani non sono tutti uguali.
Per questo la nostra maestria artigianale opera esclusivamente a
Verona. Città custode di un immenso patrimonio artistico e simbolo
di uno stile di vita esclusivo.

Люкс - это ручная работа, а не простой продукт.
Люкс реализован вручную мастерами и более ценен.
Все мастера не похожи друг на друга.
Именно поэтому наши мастера исключительно из Вероны.
Где рождается наследие искусства и образ жизни.

奢侈是匠心创造的艺术。而不仅仅是产品。
匠人所创造的奢侈是最珍贵的。
而匠人并非各个都一样。
我们只用维罗纳的匠人。
因为，这里有独特的生活与艺术底蕴。





Bruno Zampa

Founder, since 1960.



Ruben, craftsman in Bruno Zampa for 18 years.



Anna, final buffer, is checking all the smallest details in our polishing center.



Andrea, quality manager, is carrying out the last finishing touches.



A RELIABLE PARTNER FOR YOUR BUSINESS



Andrea Zampa,
General Manager,
is welcoming clients
in our Gallery.

Working with custom made luxury, one wishes to avoid problems or solve them efficiently. That's why Bruno Zampa grants:

- Budget safe approach
- Focus on custom made projects
- Company credibility, unchanged ownership since 1960
- Clever solutions for "impossible" requests
- Reliability beyond legal warranty

Nel settore del lusso e delle creazioni di alta gamma personalizzate, sono necessarie soluzioni efficienti.

Per questo Bruno Zampa garantisce:

- Rispetto del budget
- Focus su progetti personalizzati
- Solidità aziendale, sempre la stessa proprietà dal 1960
- Soluzioni efficaci per richieste "impossibili"
- Affidabilità oltre le garanzie legali

При работе с элитной продукцией, создаваемой по специальному заказу, каждый хотел бы избежать проблемных ситуаций и эффективно справиться с возникающими сложностями.

Поэтому Bruno Zampa предлагает:

- рациональный финансовый подход
- фокус на индивидуальном проекте
- надежность — руководство компании не менялось с 1960 г
- находчивые решения к твоим «невозможным» запросам
- ответственность и юридическую гарантию

选择高端定制，意味着全程无忧的高效解决方案。

这也正是 Bruno Zampa 向您做出的承诺：

- 符合您的预算设定
- 满足您的定制要求
- 卓越公司信誉，自 1960 年起从未易主
- 以最佳方案将“不可能”变为可能
- 以高于法律要求的标准，成为您的无忧选择





*Matteo De Stefani, architect,
designer of Bruno Zampa collections.*

CUSTOM
MADE
FURNITURE
FOR YOUR
DESIGN





Bruno Zampa is focused on custom made solutions:

- Extended product range, with 15.950 combinations in materials and finishing
- 43% of our overall production is customized and not in the standard range
- Our creative and technical staff is at customer's disposal to customize products and projects
- The appointed Project Manager will be the only interface to deal with

Bruno Zampa è focalizzata su soluzioni personalizzate:

- Ampia gamma disponibile, 15.950 combinazioni di materiali e finiture
- Il 43% della nostra produzione è su misura
- Il nostro staff creativo e tecnico è a disposizione per la personalizzazione di prodotti e progetti
- Il Project Manager assegnato sarà l'unico riferimento dall'avvio alla chiusura del progetto

Bruno Zampa — это индивидуальные решения:

- широкий ассортимент товаров, 15.950 сочетаний материалов и отделки мебели
- 43% нашей продукции нет в каталоге, так как она персонализирована
- Наш дизайнерский и технический персонал в твоём распоряжении, для того чтобы персонализировать модели и проекты
- У тебя будет проект-менеджер, который будет исключительно в твоём распоряжении

Bruno Zampa 专注于定制解决方案:

- 超细化产品分类, 15.950 种材料和饰面组合
- 43% 的产品都无法在目录中找到, 因为它们都是个人定制的
- 我们的创意团队和专业团队为你提供定制的产品和设计
- 你将会拥有你专属的项目经理

*Mattia, interior designer,
is creating the project's moodboard*

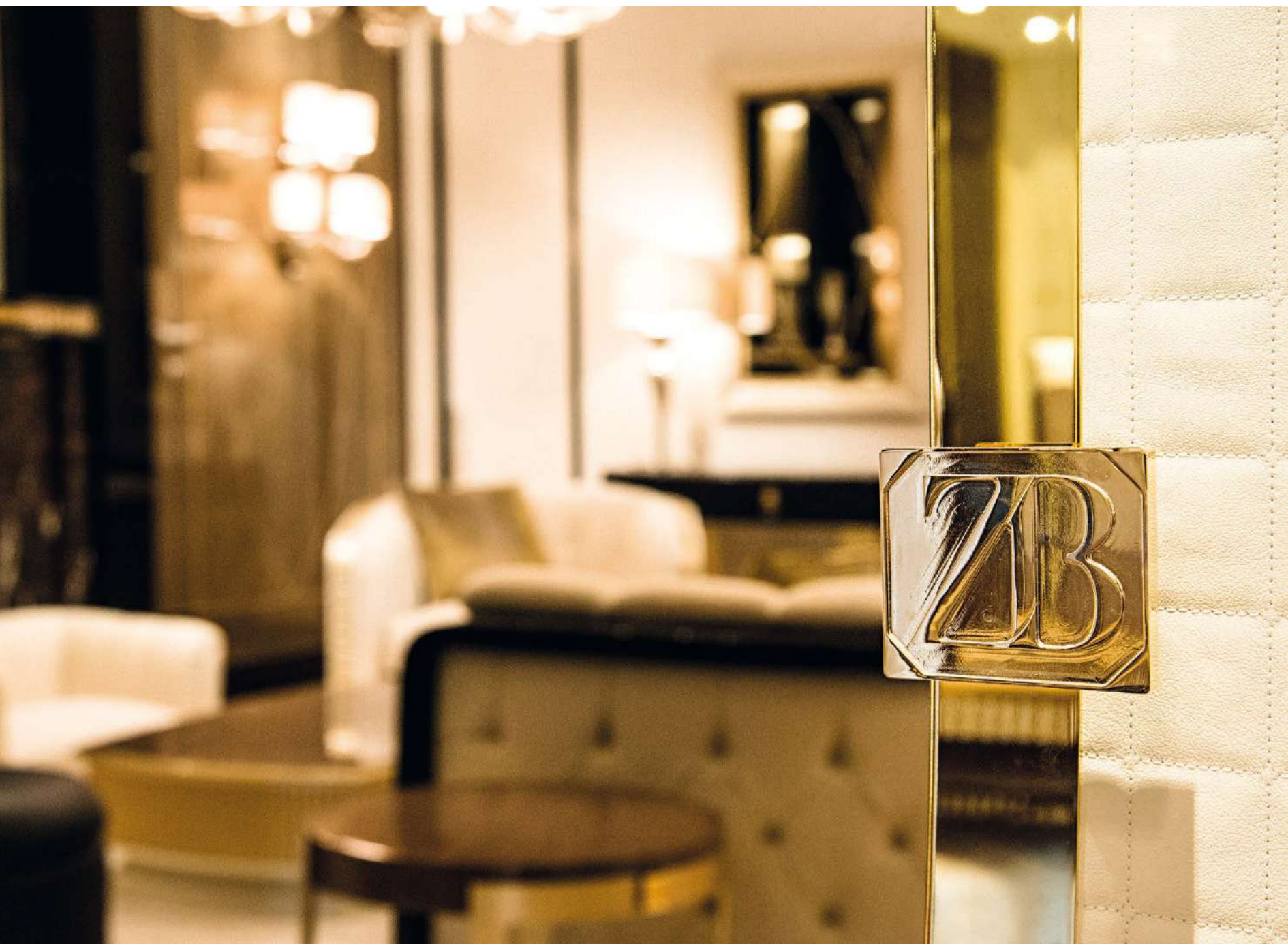

EXPERIENCE THE CRAFTSMANSHIP: COME TO THE VERONA HUB

Luxury cannot be told.
One has to touch it, smell
it and feel it. It can not be
imagined.

In our Verona HUB
customers will experience:
- Our luxury craftsmanship
at work in our 4 production
units: joinery, tailoring,
upholstery, polishing
- 11 projects in our 1.025 m²
Gallery
- The meeting with our
design team

Il lusso non può essere espresso
con parole.
Per comprenderlo è necessario
toccarlo e assaporarlo. Non può
essere semplicemente immaginato.
Nel nostro HUB i clienti possono
vedere e vivere:
- I nostri artigiani del lusso al
lavoro nelle 4 unità produttive:
 falegnameria, sartoria,
 tappezzeria, lucidatura
- 11 progetti ambientati nella
nostra gallery di 1.025 m²
- l'incontro con il nostro team di
progettazione

Роскошь невозможно выразить
словами.
Ее нужно прочувствовать:
прикоснуться к ней и ощутить
ее вкус. Не пытайтесь
представить ее.
В нашем центре в Вероне вас
ждет:
- наше мастерство изготовления
на деле: столярные работы,
подгонка, обивка и полировка
изделий
- 11 проектов в галерее
площадью 1025 м²
- знакомство с командой
дизайнеров

奢侈不可言之。
您必须触于手，嗅于鼻，感于心。
而非凭空想象。
在我们维罗纳的中心，您将体验到：
- 我们四个制作单位的精湛技艺：
细木工、剪裁、内饰和抛光
- 我们 1.025 平方米的展厅，呈现
11 个特色各异的项目
- 与我们的设计团队亲自会面沟通

AMAZON

SOFA



Struttura in legno massello; basamento in legno. Copri bracciolo in pelle con fibbia in ottone. Cuscini di seduta e schienale in vera piuma con inserto in poliuretano. Meccanismo per divano letto non disponibile.

Solid wood frame; wooden base. Leather armrest saddle-covers, with brass buckle. Seat and back cushions in natural feather with polyurethane insert. Bed mechanism not available.

Каркас из массива дерева, деревянная основа. Кожаные чехлы для подлокотников с застежкой из латуни. Подушки сиденья и спинки наполнены натуральным пером и имеют полиуретановую прокладку. Механизм трансформации отсутствует.

实木框架；木制底座。马鞍罩风格真皮扶手，饰以黄铜扣。坐垫和靠背填充天然羽毛和聚氨酯泡沫。不可用作沙发床。

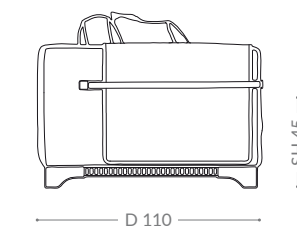
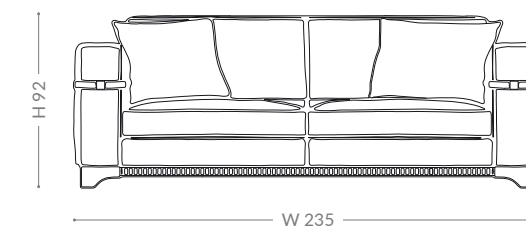

AMAZON 3 Posti/Seats/Сиденья/座位
2 cuscini inclusi
2 pillows included
2 подушки в комплекте
含 2 个抱枕

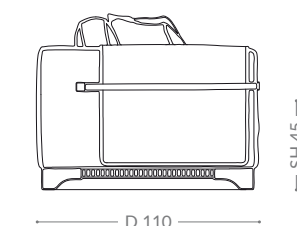
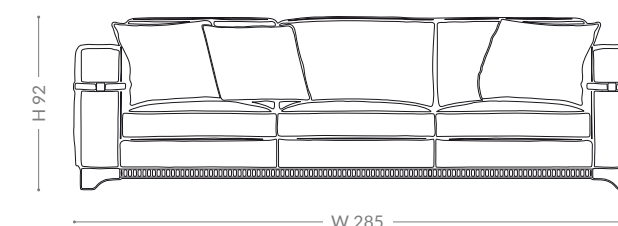

AMAZON 4 Posti/Seats/Сиденья/座位
3 cuscini inclusi
3 pillows included
3 подушки в комплекте
含 3 个抱枕

S O F A S

As picture: Amazon 4 seats
In price list: Prime/Brilliant

Divano/Sofa/Диван/沙发
BZ 187-127 VELVET SAND
BZ 904-4632 LEATHER SAND

Cuscini/Pillows/Подушки/抱枕
BZ 184-902 PALMA LIGHT BLU/BRASS
BZ 904-4632 LEATHER SAND
Lucidatura/Finishing/Отделка/饰面
55. COFFEE

Parti in metallo/Metal parts/Металлическая фурнитура/金属部件
TITANIUM

AMBASSADOR

SOFA



Struttura in legno massello. Copribracciolo in pelle ricamata. Cuscino schienale con ricamo. Cuscini di seduta e schienale in vera piuma con inserto in poliuretano. Meccanismo per divano letto non disponibile.

Solid wood frame. Quilted leather armrest saddle-covers. Quilted backrest cushion. Seat and back cushions in natural feather with polyurethane insert. Bed mechanism not available.

Каркас из массива дерева. Стеганные кожаные чехлы для подлокотников. Стеганая подушка спинки. Подушки сиденья и спинки наполнены натуральным пером и имеют полиуретановую прокладку. Механизм трансформации отсутствует.

实木框架。马鞍罩风格绗缝皮革扶手。绗缝靠背垫。坐垫和靠背填充天然羽毛和聚氨酯泡沫。不可用作沙发床。

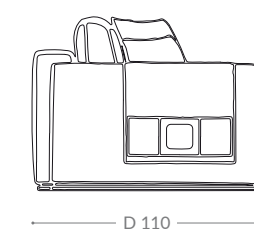
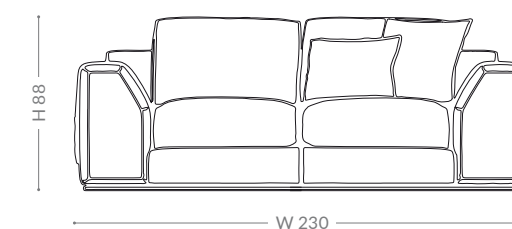

AMBASSADOR 3 Posti/Seats/
Сиденья/座位
2 cuscini inclusi
2 pillows included
2 подушки в комплекте
含 2 个抱枕

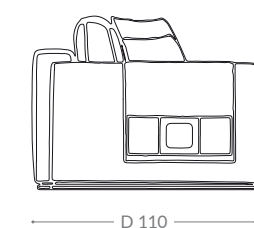
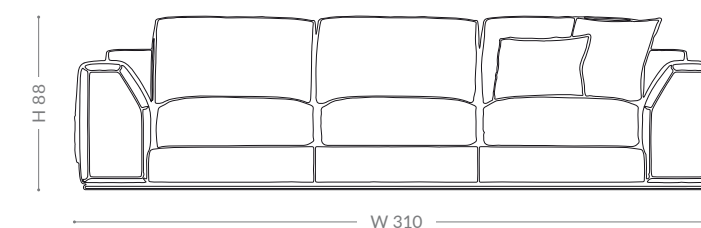

AMBASSADOR 4 Posti/Seats/
Сиденья/座位
2 cuscini inclusi
2 pillows included
2 подушки в комплекте
含 2 个抱枕

S O F A S

As picture: Ambassador 4 seats
In price list: Ambition/2
leather saddle-covers

Divano/Sofa/Диван/沙发
BZ 901-702 LEATHER DOVE GREY

Cuscini/Pillows/Подушки/抱枕
BZ 213-03 SHANTUNG PUTTY
BZ 901-702 LEATHER DOVE GREY

Lucidatura/Finishing/Отделка/饰面
89. TAUPE MATT

AMBASSADOR

MODULAR SOFA



Struttura in legno massello. Copribracciolo in pelle ricamata. Cuscino schienale con ricamo. Cuscini di seduta e schienale in vera piuma con inserto in poliuretano. Meccanismo per divano letto non disponibile.

Solid wood frame. Quilted leather armrest saddle-cover. Quilted backrest cushion. Seat and back cushions in natural feather with polyurethane insert. Bed mechanism not available.

Каркас из массива дерева. Стеганные кожаные чехлы для подлокотников. Стеганая подушка спинки. Подушки сиденья и спинки наполнены натуральным пером и имеют полиуретановую прокладку. Механизм трансформации отсутствует.

实木框架。马鞍罩风格绗缝皮革扶手。绗缝靠背垫。坐垫和靠背填充天然羽毛和聚氨酯泡沫。不可用作沙发床。



As picture: Ambassador modular (dormeuse + central element 3 seats + side table + side element 3 seats)
In price list: Prestige/leather saddle-cover

Divano/Sofa/Диван/沙发
BZ 191-001 JACQUARD BEIGE
BZ 905-5234 LEATHER BEIGE

Cuscini/Pillows/Подушки/抱枕
BZ 191-001 JACQUARD BEIGE
BZ 905-5234 LEATHER BEIGE

Lucidatura/Finishing/Отделка/饰面
81. SAND MATT
70. CANALETTO WALNUT MATT

AMBASSADOR

MODULAR SOFA

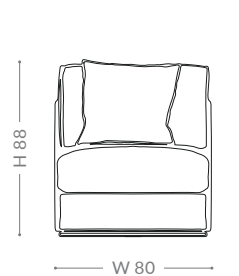

AMBASSADOR Elemento centrale 1 posto/
Central element 1 seat/Центральный элемент с 1 сиденьем/中位组件 1 人位
1 cuscino incluso
1 pillow included
1 подушка в комплекте
含 1 个抱枕

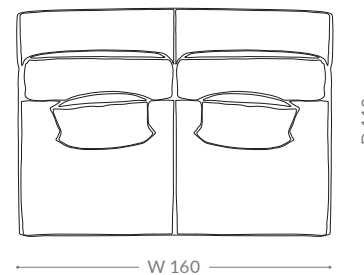
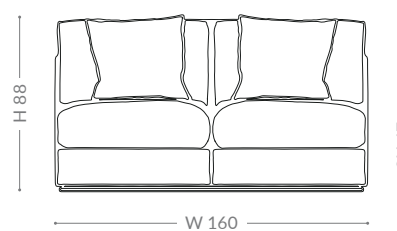

AMBASSADOR Elemento centrale 2 posti/
Central element 2 seats/Центральный элемент с 2 сиденьями/中位组件 2 人位
2 cuscini inclusi
2 pillows included
2 подушки в комплекте
含 2 个抱枕

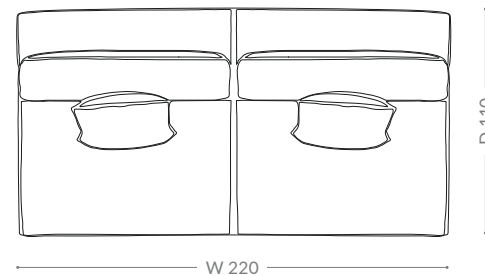
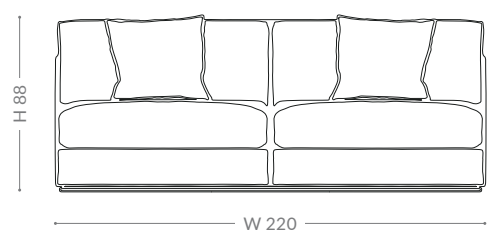

AMBASSADOR Elemento centrale 3 posti/
Central element 3 seats/Центральный элемент с 3 сиденьями/中位组件 3 人位
2 cuscini inclusi
2 pillows included
2 подушки в комплекте
含 2 个抱枕

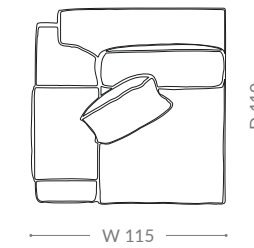
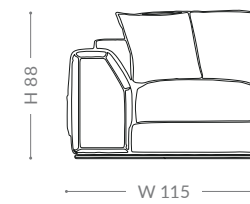

AMBASSADOR Elemento laterale 1 posto/
Side element 1 seat/Боковой элемент с 1 сиденьем/侧位组件 1 人位
1 cuscino incluso
1 pillow included
1 подушка в комплекте
含 1 个抱枕

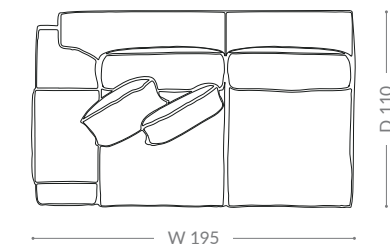
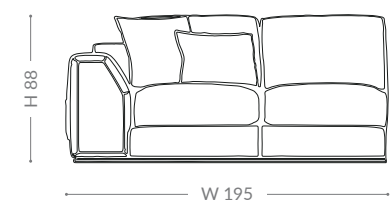

AMBASSADOR Elemento laterale 2 posti/
Side element 2 seats/Боковой элемент с 2 сиденьями/侧位组件 2 人位
2 cuscini inclusi
2 pillows included
2 подушки в комплекте
含 2 个抱枕

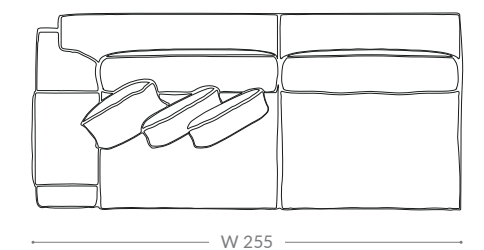
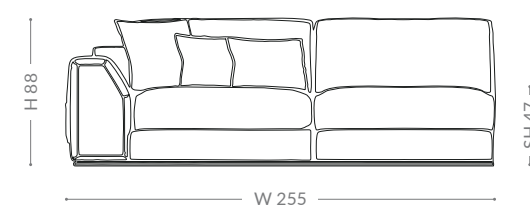

AMBASSADOR Elemento laterale 3 posti/
Side element 3 seats/Боковой элемент с 3 сиденьями/侧位组件 3 人位
3 cuscini inclusi
3 pillows included
3 подушки в комплекте
含 3 个抱枕

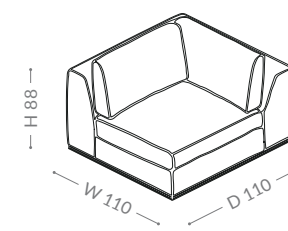

AMBASSADOR Elemento d'angolo/
Corner element/Угловой элемент/转角组件
0 cuscini inclusi
0 pillows included
0 подушки в комплекте
含 0 个抱枕

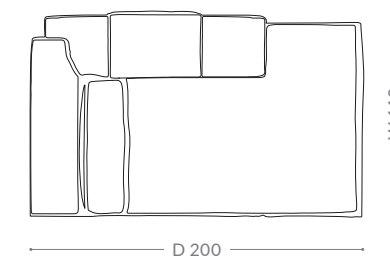
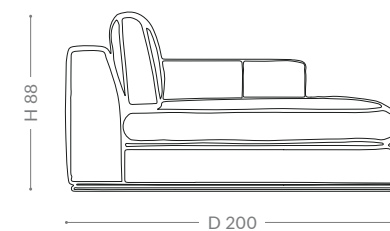

AMBASSADOR Dormeuse/
Dormeuse/Кушетка/沙发躺椅
0 cuscini inclusi
0 pillows included
0 подушки в комплекте
含 0 个抱枕

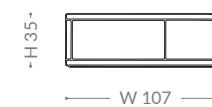

AMBASSADOR Tavolo quadrato/
Corner table/Угловой стол/角桌

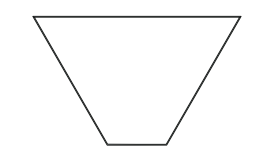
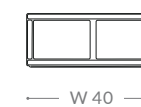
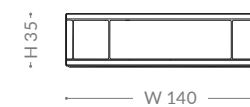

AMBASSADOR Tavolo trapezio/
Angular table/Многоугольный стол/棱角桌

BABYLON

SOFA



Struttura in legno massello; basamento in legno. Schienale e braccioli capitonné. Cuscini di seduta in vera piuma con inserto in poliuretano. Disponibile con meccanismo per divano letto.

Solid wood frame; wooden base. Capitonné backrest and armrests. Seat cushions in natural feather with polyurethane insert. Available with bed mechanism.

Каркас из массива дерева, деревянная основа. Спинка и подлокотники с обивкой в виде каретной стяжки. Подушки сиденья наполнены натуральным пером и имеют полиуретановую прокладку. Есть механизм трансформации.

实木框架；木制底座。分块铆钉装饰（靠背和扶手）。坐垫填充天然羽毛和聚氨酯泡沫。可用作沙发床。

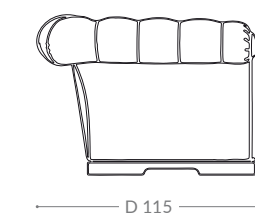
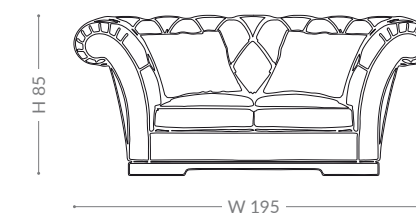

BABYLON 2 Posti/Seats/Сиденья/座位
2 cuscini inclusi
2 pillows included
2 подушки в комплекте
含 2 个抱枕

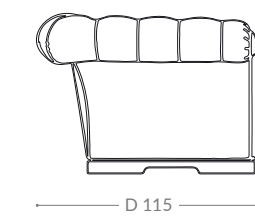
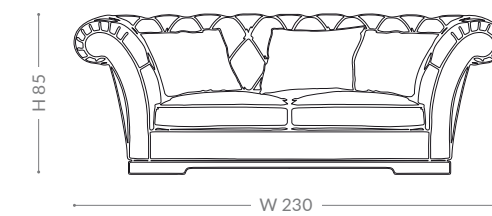

BABYLON 3 Posti/Seats/Сиденья/座位
3 cuscini inclusi
3 pillows included
3 подушки в комплекте
含 3 个抱枕

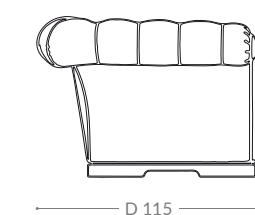
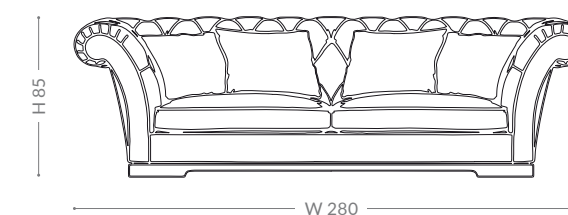

BABYLON 4 Posti/Seats/Сиденья/座位
4 cuscini inclusi
4 pillows included
4 подушки в комплекте
含 4 个抱枕

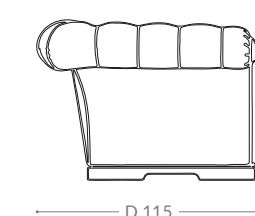
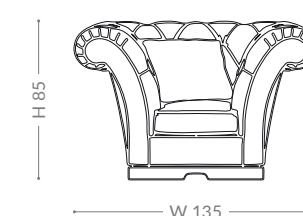

BABYLON Poltrona/Armchair/Кресло/扶手沙发椅
1 cuscino incluso
1 pillow included
1 подушка в комплекте
含 1 个抱枕

S O F A S

As picture: Babylon 4 seats
In price list: Ambition/Brilliant

Divano/Sofa/Диван/沙发
BZ 901-702 LEATHER DOVE GREY

Cuscini/Pillows/Подушки/抱枕
BZ 126-51 UNITO GREY PEARL
BZ 219-22 SATIN PLISSÉ GREY

Lucidatura/Finishing/Отделка/饰面
54. GREY

BARRYMORE

SOFA



Struttura in legno massello, basamento in legno di faggio. Esterno braccioli in pelle ricamata. Cuscini di seduta in vera piuma con inserto in poliuretano. Meccanismo per divano letto non disponibile.

Solid wood frame; wooden base. Leather decoration on outer armrests. Seat cushions in natural feather with polyurethane insert. Bed mechanism not available.

Каркас из массива дерева, основа из бука. Кожаная отделка внешней части подлокотников. Подушки сиденья наполнены натуральным пером и имеют полиуретановую прокладку. Механизм трансформации отсутствует.

实木框架；山毛榉底座。扶手外侧采用皮革装饰。坐垫填充天然羽毛和聚氨酯泡沫。不可用作沙发床。

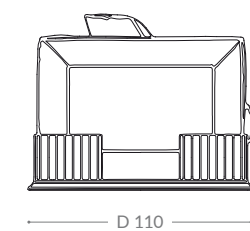
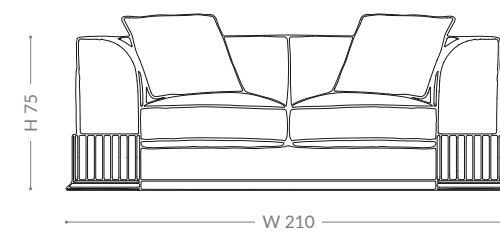

BARRYMORE 2 Posti/Seats/
Сиденья/座位
2 cuscini inclusi
2 pillows included
2 подушки в комплекте
含 2 个抱枕

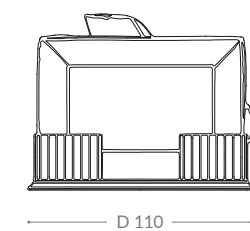
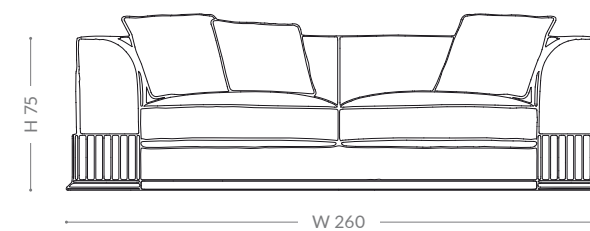

BARRYMORE 3 Posti/Seats/
Сиденья/座位
3 cuscini inclusi
3 pillows included
3 подушки в комплекте
含 3 个抱枕

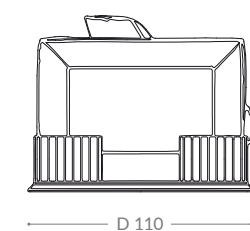
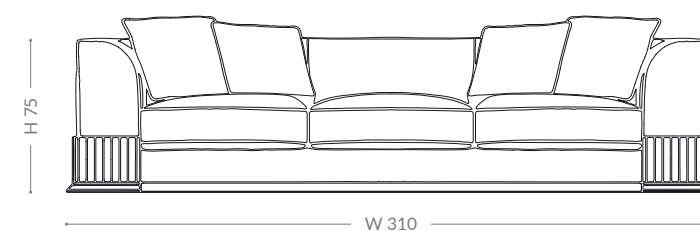

BARRYMORE 4 Posti/Seats/
Сиденья/座位
4 cuscini inclusi
4 pillows included
4 подушки в комплекте
含 4 个抱枕

As picture: Barrymore 3 seats
In price list: Prime/Brilliant

Divano/Sofa/Диван/沙发
BZ 187-161 VELVET BLUE GREY
BZ 901-501 LEATHER BLUE PRUSSIA

Cuscini/Pillows/Подушки/抱枕
BZ 170-901 PIXEL BLUE PRUSSIA
BZ 901-501 LEATHER BLUE PRUSSIA

Lucidatura/Finishing/Отделка/饰面
58. BLACK

BARRYMORE

MODULAR SOFA



Struttura in legno massello, basamento in legno di faggio. Esterno braccioli in pelle ricamata. Cuscini di seduta in vera piuma con inserto in poliuretano. Meccanismo per divano letto non disponibile.

Solid wood frame; wooden base. Leather decoration on outer armrests. Seat cushions in natural feather with polyurethane insert. Bed mechanism not available.

Каркас из массива дерева, основа из бука. Кожаная отделка внешней части подлокотников. Подушки сиденья наполнены натуральным пером и имеют полиуретановую прокладку. Механизм трансформации отсутствует.

实木框架; 山毛榉底座。扶手外侧采用皮革装饰。坐垫填充天然羽毛和聚氨酯泡沫。不可用作沙发床。

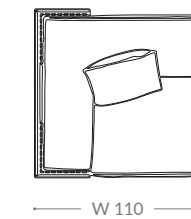
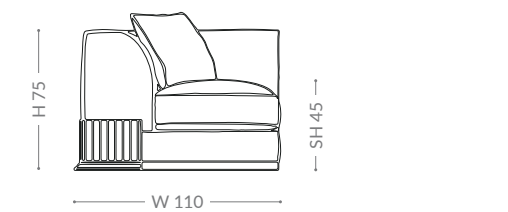

BARRYMORE Elemento laterale 1 posto
Side element 1 seat/Боковой элемент с 1 сиденьем/侧位组件 1 人位
1 cuscino incluso
1 pillow included
1 подушка в комплекте
含 1 个抱枕

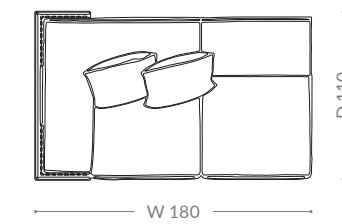
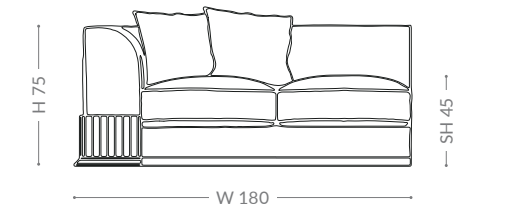

BARRYMORE Elemento laterale 2 posti
Side element 2 seats/Боковой элемент с 2 сиденьями/侧位组件 2 人位
2 cuscini inclusi
2 pillows included
2 подушки в комплекте
含 2 个抱枕

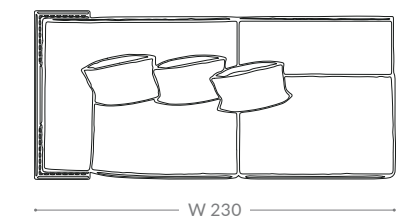
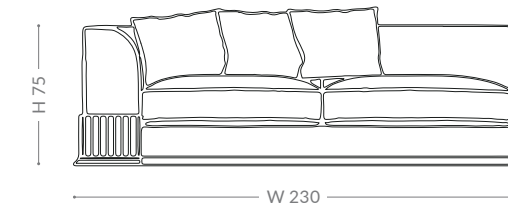

BARRYMORE Elemento laterale 3 posti
Side element 3 seats/Боковой элемент с 3 сиденьями/侧位组件 3 人位
3 cuscini inclusi
3 pillows included
3 подушки в комплекте
含 3 个抱枕

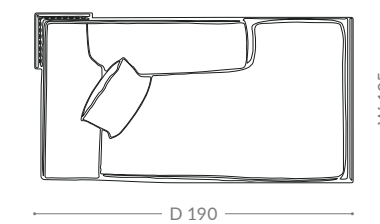
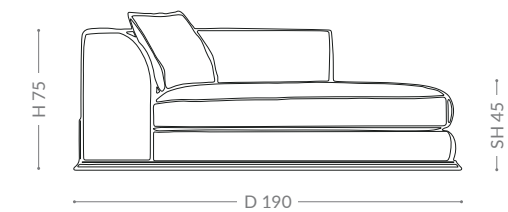

BARRYMORE Dormeuse/
Dormeuse/Кухетка/沙发躺椅
1 cuscino incluso
1 pillow included
1 подушка в комплекте
含 1 个抱枕

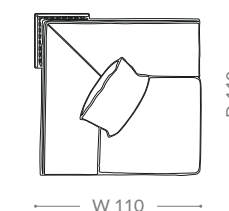
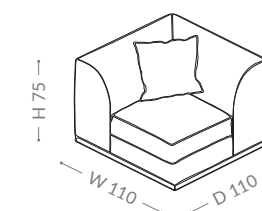

BARRYMORE Elemento d'angolo/
Corner element/Угловой элемент/转角组件
1 cuscino incluso
1 pillow included
1 подушка в комплекте
含 1 个抱枕

S O F A S

As picture: Barrymore modular (side element cm 180 + corner element + side element cm 230)
In price list: Prime/Brilliant

Divano/Sofa/Диван/沙发
BZ 187-127 VELVET SAND
BZ 901-432 LEATHER LIGHT BEIGE

Cuscini/Pillows/Подушки/抱枕
BZ 126-50 UNITO SAND/PEARL
BZ 183-901 RAILING WHITE/GOLD
BZ 187-127 VELVET SAND
BZ 901-432 LEATHER LIGHT BEIGE

Lucidatura/Finishing/Отделка/饰面
51. SAND

BAUHAUS

SOFA



Struttura in legno massello. Schienale esterno in listellare/MDF con lavorazione verticale e decorazione in legno applicata sul perimetro. Schienale trapuntato a rombi con bottoni. Cuscini di seduta in vera piuma con inserto in poliuretano. Meccanismo per divano letto non disponibile.

Solid wood frame. Outer body in blockboard/MDF with fluted decoration. Wooden elements applied on the edge. Quilted backrest with buttons. Seat cushions in natural feather with polyurethane insert. Bed mechanism not available.

Каркас из массива дерева. Внешняя часть корпуса выполнена из столлярной плиты/МДФ с рельефной отделкой. Края украшены деревянными элементами. Стеганая спинка с пуговицами. Подушки сиденья наполнены натуральным пером и имеют полиуретановую прокладку. Механизм трансформации отсутствует.

实木框架。外侧部分为带凹槽装饰的细木工板/中密度纤维板。沙发边缘镶嵌木制组件。绗缝靠背（带纽扣）。坐垫填充天然羽毛和聚氨酯泡沫。不可用作沙发床。



S O F A S

As picture: Bauhaus 3 seats
In price list: Prestige/Brilliant

Divano/Sofa/Диван/沙发
BZ 188-07 BOUCLÉ SAND

Cuscini/Pillows/Подушки/抱枕
BZ 902-N8408 NABUK CHAMOIS
BZ 184-901 PALMA BEIGE/IVORY

Lucidatura/Finishing/Отделка/饰面
57. CHOCOLATE

BAUHAUS

SOFA

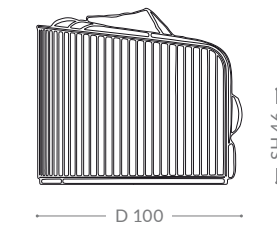

BAUHAUS 2 Posti/Seats/Сиденья/
座位
2 cuscini inclusi
2 pillows included
2 подушки в комплекте
含 2 个抱枕

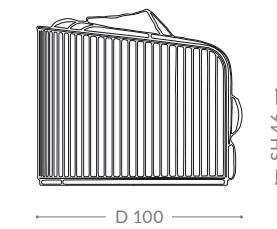
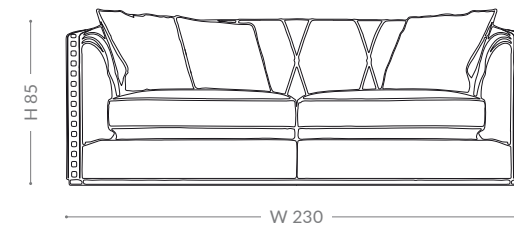

BAUHAUS 3 Posti/Seats/Сиденья/
座位
3 cuscini inclusi
3 pillows included
3 подушки в комплекте
含 3 个抱枕

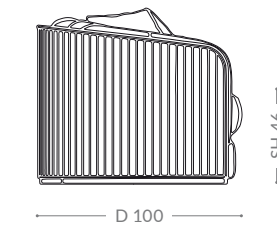
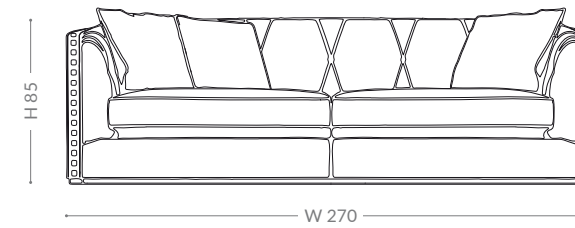

BAUHAUS 4 Posti/Seats/Сиденья/
座位
3 cuscini inclusi
3 pillows included
3 подушки в комплекте
含 3 个抱枕

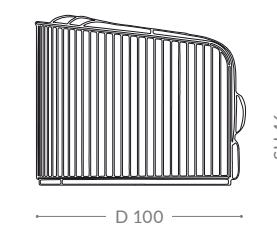
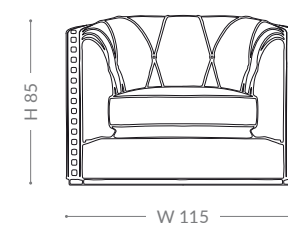

BAUHAUS Poltrona/Armchair/
Кресло/扶手沙发椅
0 cuscini inclusi
0 pillows included
0 подушки в комплекте
含 0 个抱枕

S O F A S

As picture: Bauhaus 3 seats
In price list: Prestige/Brilliant

Divano/Sofa/Диван/沙发
BZ 216-073 VELVET SAND

Cuscini/Pillows/Подушки/抱枕
BZ 126-52 UNITO IVORY

Lucidatura/Finishing/Отделка/饰面
51. SAND

CLUB

SOFA



Struttura in legno massello. Piedini in legno intagliati a mano; parte esterna in legno multistrati decorata con traforo. Cuscini di seduta e schienale in vera piuma con inserto in poliuretano. Meccanismo per divano letto non disponibile.

Solid wood frame. Hand-carved wooden feet; fretwork plywood outer frame. Seat and back cushions in natural feather with polyurethane insert. Bed mechanism not available.

Каркас из массива дерева. Деревянные ножки ручной работы, наружный резной каркас из фанеры. Подушки сиденья и спинки наполнены натуральным пером и имеют полиуретановую прокладку. Механизм трансформации отсутствует.

实木框架。木制沙发脚采用手工雕刻；外框采用浮雕胶合板。坐垫和靠背填充天然羽毛和聚氨酯泡沫。不可用作沙发床。

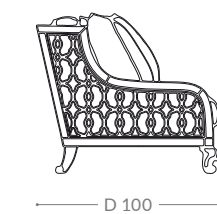
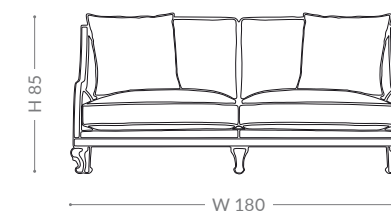

CLUB 2 Posti/Seats/Сиденья/座位
2 cuscini inclusi
2 pillows included
2 подушки в комплекте
含 2 个抱枕

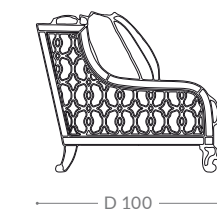
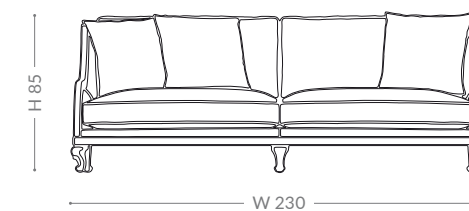

CLUB 3 Posti/Seats/Сиденья/座位
3 cuscini inclusi
3 pillows included
3 подушки в комплекте
含 3 个抱枕

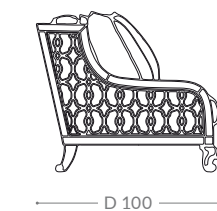
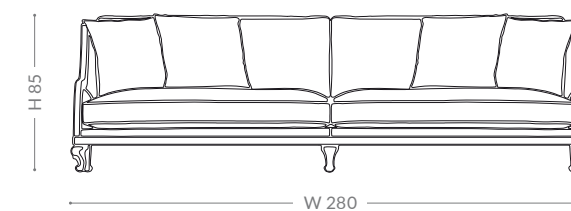

CLUB 4 Posti/Seats/Сиденья/座位
4 cuscini inclusi
4 pillows included
4 подушки в комплекте
含 4 个抱枕

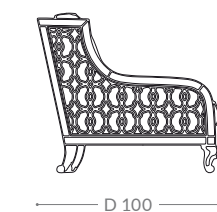
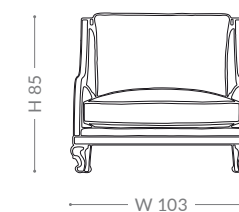

CLUB Poltrona/Armchair/Кресло/
扶手沙发椅
0 cuscini inclusi
0 pillows included
0 подушки в комплекте
含 0 个抱枕

S O F A S

As picture: Club 3 seats
In price list: Prime/Brilliant

Divano/Sofa/Диван/沙发
BZ 187-131 VELVET TEAL
BZ 901-702 LEATHER DOVE GREY

Cuscini/Pillows/Подушки/抱枕
BZ 183-902 RAILING LIGHT BLUE/GOLD
BZ 188-06 BOUCLÉ TEAL

Lucidatura/Finishing/Отделка/饰面
54. GREY

COCÒ

SOFA



Struttura in legno massello. Fascia perimetrale in legno di faggio sagomato. Parte esterna capitonné. Cuscini di seduta in vera piuma con inserto in poliuretano. Meccanismo per divano letto non disponibile.

Solid wood frame. Outer profile band in shaped wood. Capitoné outer body. Seat cushions in natural feather with polyurethane insert. Bed mechanism not available.

Каркас из массива дерева. Фигурная наружная полоса профиля из бука. Внешняя часть корпуса с обивкой в виде каретной стяжки. Подушки сиденья наполнены натуральным пером и имеют полиуретановую прокладку. Механизм трансформации отсутствует.

实木框架。外部轮廓为山毛榉型材镶边。外侧部分采用分块铆钉装饰。坐垫填充天然羽毛和聚氨酯泡沫。不可用作沙发床。

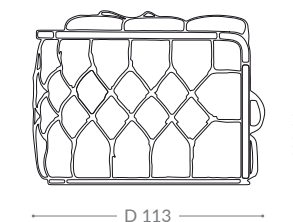
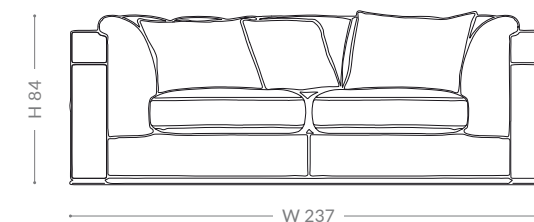

COCÒ 3 Posti/Seats/Сиденья/座位
3 cuscini inclusi
3 pillows included
3 подушки в комплекте
含 3 个抱枕

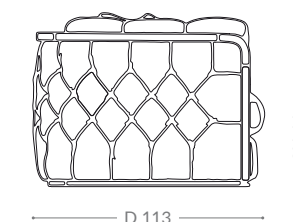
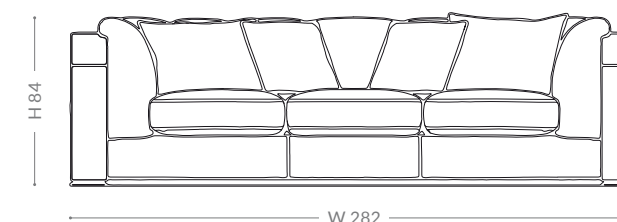

COCÒ 4 Posti/Seats/Сиденья/座位
4 cuscini inclusi
4 pillows included
4 подушки в комплекте
含 4 个抱枕

S O F A S

As picture: Cocò 4 seats
In price list: Prime/Brilliant

Divano/Sofa/Диван/沙发
BZ 187-147 VELVET HAZELNUT
BZ 904-4632 LEATHER SAND

Cuscini/Pillows/Подушки/抱枕
BZ 126-50 UNITO SAND/PEARL
BZ 904-4632 LEATHER SAND

Lucidatura/Finishing/Отделка/饰面
57. CHOCOLATE

DAVIS

SOFA



Struttura in legno massello; basamento in legno. Schienale e braccioli capitonné. Cuscini di seduta in vera piuma con inserto in poliuretano. Meccanismo per divano letto non disponibile.

Solid wood frame; wooden base. Capitonné backrest and armrests. Seat cushions in natural feather with polyurethane insert. Bed mechanism not available.

Каркас из массива дерева, деревянная основа. Спинка и подлокотники с обивкой в виде каретной стяжки. Подушки сиденья наполнены натуральным пером и имеют полиуретановую прокладку. Механизм трансформации отсутствует.

实木框架；木制底座。分块铆钉装饰（靠背和扶手）。坐垫填充天然羽毛和聚氨酯泡沫。不可用作沙发床。



S O F A S

As picture: Davis 3 seats
In price list: Ambition/Brilliant

Divano/Sofa/Диван/沙发
BZ 901-891 LEATHER IVORY

Cuscini/Pillows/Подушки/抱枕
BZ 126-52 UNITO IVORY
BZ 171-901 MATELASSÉ IVORY

Lucidatura/Finishing/Отделка/饰面
51. SAND

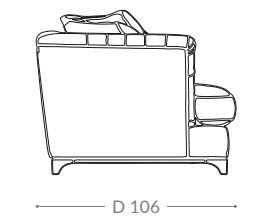
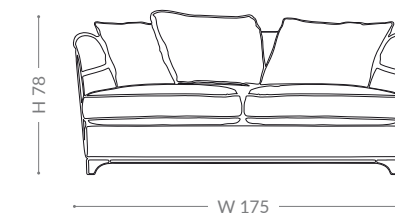

DAVIS 2 Posti/Seats/Сиденья/座位
3 cuscini inclusi
3 pillows included
3 подушки в комплекте
含 3 个抱枕

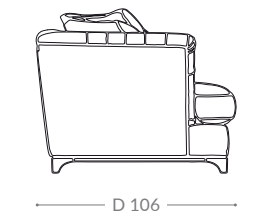
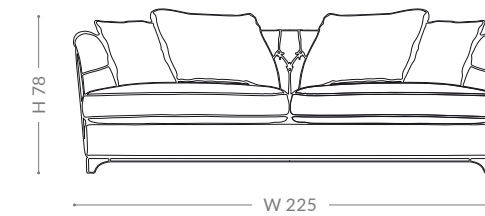

DAVIS 3 Posti/Seats/Сиденья/座位
4 cuscini inclusi
4 pillows included
4 подушки в комплекте
含 4 个抱枕

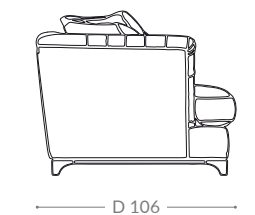
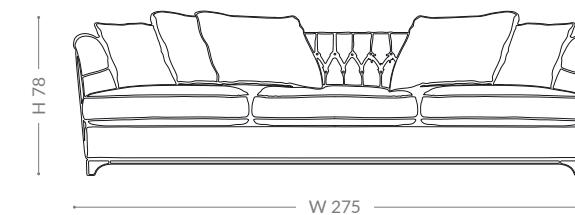

DAVIS 4 Posti/Seats/Сиденья/座位
5 cuscini inclusi
5 pillows included
5 подушки в комплекте
含 5 个抱枕

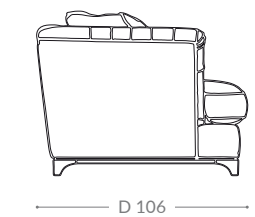

DAVIS Poltrona/Armchair/Кресло/
扶手沙发椅
1 cuscino incluso
1 pillow included
1 подушка в комплекте
含 1 个抱枕

DAVIS

MODULAR SOFA



Struttura in legno massello; basamento in legno. Schienale e braccioli capitonné. Cuscini di seduta in vera piuma con inserto in poliuretano. Meccanismo per divano letto non disponibile.

Solid wood frame; wooden base. Capitonné backrest and armrests. Seat cushions in natural feather with polyurethane insert. Bed mechanism not available.

Каркас из массива дерева, деревянная основа. Спинка и подлокотники с обивкой в виде каретной стяжки. Подушки сиденья наполнены натуральным пером и имеют полиуретановую прокладку. Механизм трансформации отсутствует.

实木框架；木制底座。分块铆钉装饰（靠背和扶手）。坐垫填充天然羽毛和聚氨酯泡沫。不可用作沙发床。

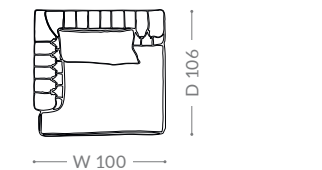

DAVIS Elemento laterale 1 posto/Side element 1 seat /Боковой элемент с 1 сиденьем/侧位组件 1 人位

1 cuscino incluso
1 pillow included
1 подушка в комплекте
含 1 个抱枕

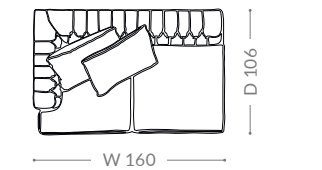
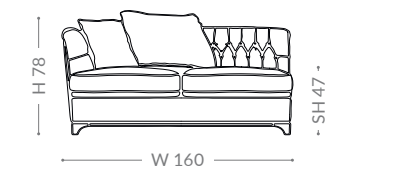

DAVIS Elemento laterale 2 posti/Side element 2 seats/Боковой элемент с 2 сиденьями/侧位组件 2 人位

2 cuscini inclusi
2 pillows included
2 подушки в комплекте
含 2 个抱枕

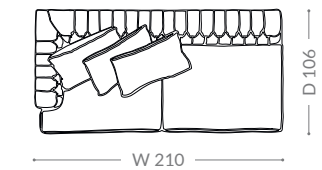
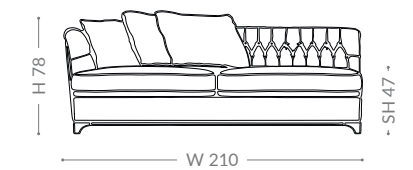

DAVIS Elemento laterale 3 posti/Side element 3 seats/Боковой элемент с 3 сиденьями/侧位组件 3 人位

3 cuscini inclusi
3 pillows included
3 подушки в комплекте
含 3 个抱枕

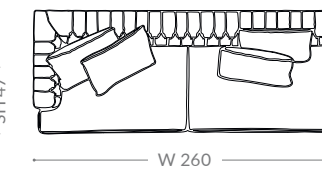
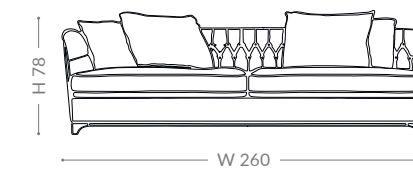

DAVIS Elemento laterale 4 posti/Side element 4 seats/Боковой элемент с 4 сиденьями/侧位组件 4 人位

4 cuscini inclusi
4 pillows included
4 подушки в комплекте
含 4 个抱枕

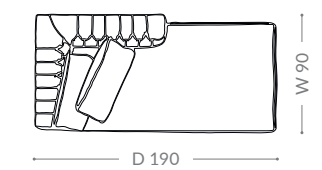
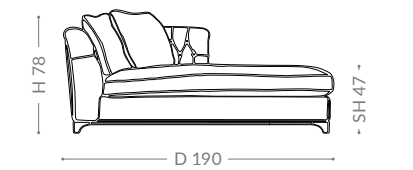

DAVIS Dormeuse/Dormeuse/Кухетка/沙发躺椅

2 cuscini inclusi
2 pillows included
2 подушки в комплекте
含 2 个抱枕

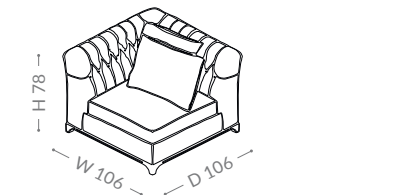

DAVIS Elemento d'angolo/Corner element/Угловой элемент/转角组件

2 cuscini inclusi
2 pillows included
2 подушки в комплекте
含 2 个抱枕

EMPERADOR

SOFA

Struttura in legno massello.
Parte esterna capitonné.
Cuscini di seduta in vera piuma
con inserto in poliuretano.
Meccanismo per divano letto
disponibile.

Solid wood frame. Capitonné
outer body. Seat cushions
in natural feather with
polyurethane insert. Available
with bed mechanism.

Каркас из массива дерева.
Внешняя часть корпуса с
обивкой в виде каретной
стяжки. Подушки сиденья
наполнены натуральным
пером и имеют полиуретано-
вую прокладку. Есть меха-
низм трансформации.

实木框架。外侧部分采用分块
铆钉装饰。坐垫填充天然羽毛
和聚氨酯泡沫。可用作沙发
床。



S O F A S

As picture: Emperador 4 seats
In price list: Prime

Divano/Sofa/Диван/沙发
BZ 200-803 VELVET GREY
BZ 905-5230 LEATHER GREY

Cuscini/Pillows/Подушки/抱枕
BZ 192-003 CHEVRON GREY
BZ 184-904 PALMA GREY

Lucidatura/Finishing/Отделка/饰面
83. DUST GREY MATT

EMPERADOR

SOFA



S O F A S

As picture: Emperor 4 seats
In price list: Prestige

Divano/Sofa/Диван/沙发
BZ 211-1120 VELVET MELANGE BURGUNDY
BZ 906-2030 LEATHER BURGUNDY

Cuscini/Pillows/Подушки/抱枕
BZ 216-120 VELVET RHUBARB
BZ 906-2030 LEATHER BURGUNDY

Lucidatura/Finishing/Отделка/饰面
85. CHOCOLATE MATT

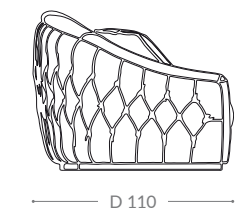
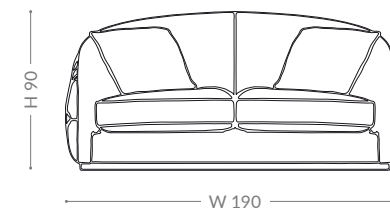

EMPERADOR 2 Posti/Seats/
Сиденья/座位
2 cuscini inclusi
2 pillows included
2 подушки в комплекте
含 2 个抱枕

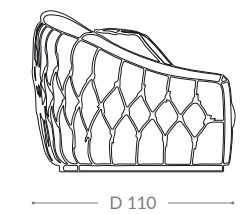
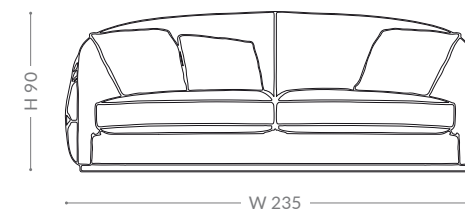

EMPERADOR 3 Posti/Seats/
Сиденья/座位
3 cuscini inclusi
3 pillows included
3 подушки в комплекте
含 3 个抱枕

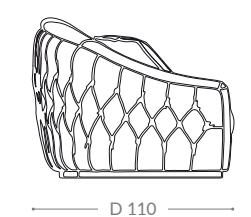
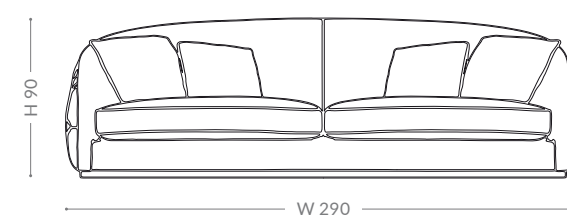

EMPERADOR 4 Posti/Seats/
Сиденья/座位
4 cuscini inclusi
4 pillows included
4 подушки в комплекте
含 4 个抱枕

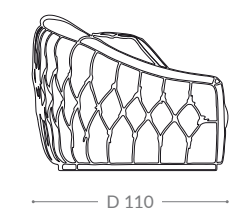
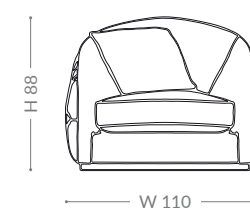

EMPERADOR Poltrona/Armchair/
Кресло/扶手沙发椅
1 cuscino incluso
1 pillow included
1 подушка в комплекте
含 1 个抱枕

FLY

SOFA



Struttura in legno massello; basamento in legno di faggio sagomato. Cuscini di seduta in vera piuma con inserto in poliuretano. Meccanismo per divano letto non disponibile.

Solid wood frame; shaped wooden base. Seat cushions in natural feather with polyurethane insert. Bed mechanism not available.

Каркас из массива дерева, фигурная основа из бука. Подушки сиденья наполнены натуральным пером и имеют полиуретановую прокладку. Механизм трансформации отсутствует.

实木框架；山毛榉型材底座。坐垫填充天然羽毛和聚氨酯泡沫。不可用作沙发床。



S O F A S

As picture: Fly 3 seats
In price list: Prime/Brilliant

Divano/Sofa/Диван/沙发
BZ 187-125 VELVET DOVE GREY

Cuscini/Pillows/Подушки/抱枕
BZ 126-51 UNITO GREY/PEARL
BZ 117-03 SMALL SILVER HEXAGON
BZ 901-702 LEATHER DOVE GREY

Lucidatura/Finishing/Отделка/饰面
54. GREY

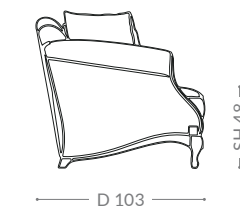
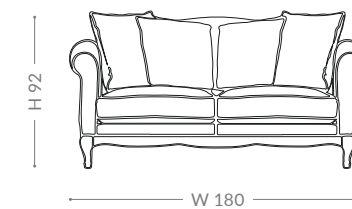

FLY 2 Posti/Seats/Сиденья/座位
4 cuscini inclusi
4 pillows included
4 подушки в комплекте
含 4 个抱枕

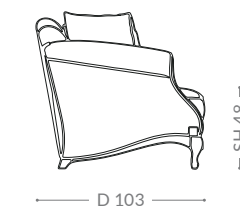
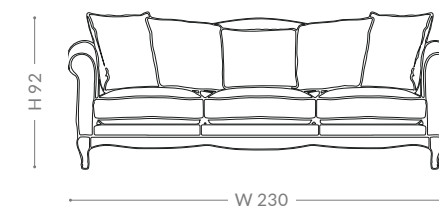

FLY 3 Posti/Seats/Сиденья/座位
5 cuscini inclusi
5 pillows included
5 подушки в комплекте
含 5 个抱枕

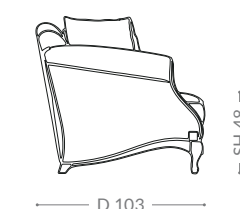
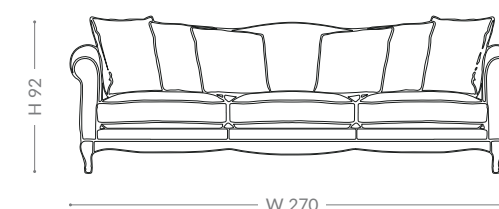

FLY 4 Posti/Seats/Сиденья/座位
6 cuscini inclusi
6 pillows included
6 подушки в комплекте
含 6 个抱枕

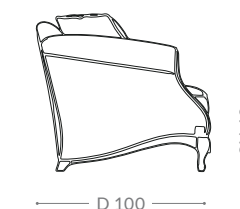
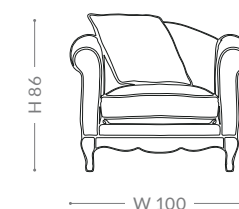

FLY Poltrona/Armchair/Кресло/
扶手沙发椅
1 cuscino incluso
1 pillow included
1 подушка в комплекте
含 1 个抱枕

GATSBY

SOFA

Struttura in legno massello; basamento e parti lucidate in legno di faggio. Cuscini di seduta in vera piuma con inserto in poliuretano. Meccanismo per divano letto non disponibile.

Solid wood frame; polished parts and base in beechwood. Seat cushions in natural feather with polyurethane insert. Bed mechanism not available.

Каркас из массива дерева, глянцевые детали и основа из бука. Подушки сиденья наполнены натуральным пером и имеют полиуретановую прокладку. Механизм трансформации отсутствует.

实木框架；抛光部件，山毛榉底座。坐垫填充天然羽毛和聚氨酯泡沫。不可用作沙发床。



As picture: **Gatsby 3 seats**
In price list: Prestige/Brilliant

Divano/Sofa/Диван/沙发
BZ 171-901 MATELASSÉ IVORY
BZ 901-332 LEATHER BUTTER

Cuscini/Pillows/Подушки/抱枕
BZ 170-901 PIXEL BLUE PRUSSIA
BZ 902 NABUK BLUE

Lucidatura/Finishing/Отделка/饰面
57. CHOCOLATE

GATSBY

SOFA



S O F A S

As picture: Gatsby 4 seats
In price list: Prime

Divano/Sofa/Диван/沙发
BZ 187-125 VELVET DOVE GREY
BZ 901-702 LEATHER DOVE GREY

Cuscini/Pillows/Подушки/抱枕
BZ 901-702 LEATHER DOVE GREY
BZ 126-51 UNITO GREY/PEARL

Lucidatura/Finishing/Отделка/饰面
100. GREY MATT

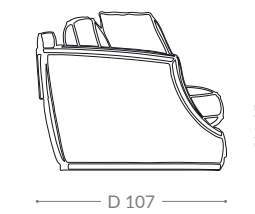
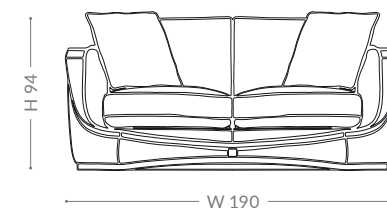

GATSBY 2 Posti/Seats/Сиденья/座位
2 cuscini inclusi
2 pillows included
2 подушки в комплекте
含 2 个抱枕

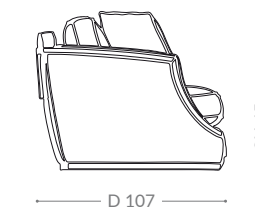
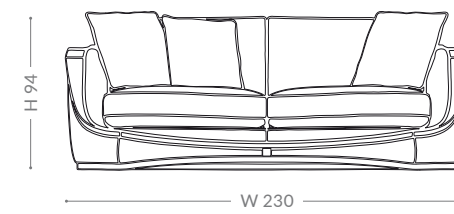

GATSBY 3 Posti/Seats/Сиденья/座位
3 cuscini inclusi
3 pillows included
3 подушки в комплекте
含 3 个抱枕

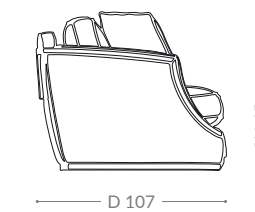
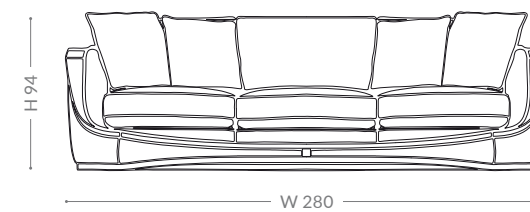

GATSBY 4 Posti/Seats/Сиденья/座位
4 cuscini inclusi
4 pillows included
4 подушки в комплекте
含 4 个抱枕

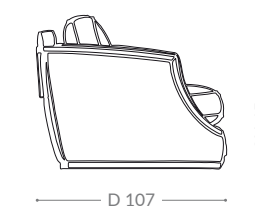
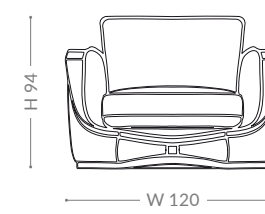

GATSBY Poltrona/Armchair/
Кресло/扶手沙发椅
0 cuscini inclusi
0 pillows included
0 подушки в комплекте
含 0 个抱枕

GIASONE

SOFA

Struttura in legno massello. Parte esterna decorata a rombi. Cuscini seduta e schienale in poliuretano a quote differenziate. Meccanismo per divano letto non disponibile.

Solid wood frame. Quilted outer body. Multiple densities polyurethane foam seating and backrest. Bed mechanism not available.

Каркас из массива дерева. Стеганая внешняя часть корпуса. Пенополиуретан разной плотности. Механизм трансформации отсутствует.

实木框架。外侧部分绗缝。多重密度聚氨酯泡沫。不可用作沙发床。



S O F A S

As picture: Giasone 4 seats
In price list: Exclusive/Brilliant

Divano/Sofa/Диван/沙发
BZ 203-004 BOUCLÉ TIFFANY
BZ 906-2006 LEATHER TAUPE

Cuscini/Pillows/Подушки/抱枕
BZ 205-027 VELVET TIFFANY
BZ 204-695 JACQUARD TIFFANY

Lucidatura/Finishing/Отделка/饰面
54. GREY

GIASONE
SOFA

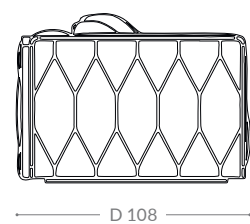
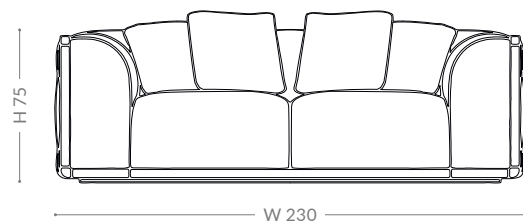

GIASONE 3 Posti/Seats/Сиденья/
座位
4 cuscini inclusi
4 pillows included
4 подушки в комплекте
含 4 个抱枕

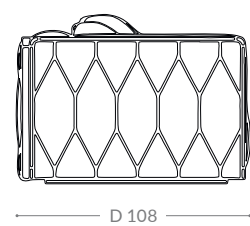
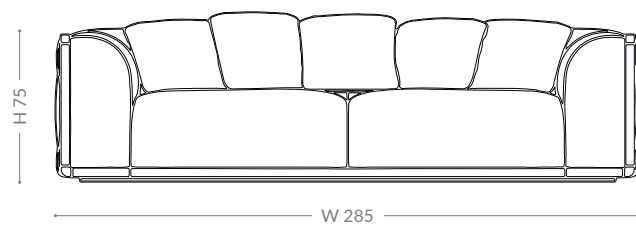

GIASONE 4 Posti/Seats/Сиденья/
座位
5 cuscini inclusi
5 pillows included
5 подушки в комплекте
含 5 个抱枕

GIASONE

MODULAR SOFA



As picture: Giasone modular
(2 side elements cm 200 + side table)
In price list: Prestige/Brilliant

Divano/Sofa/Диван/沙发
BZ 205-017 VELVET BEIGE
BZ 905-5234 LEATHER BEIGE

Cuscini/Pillows/Подушки/抱枕
BZ 214-03 VELVET CARVED BLUE
BZ 905-5234 LEATHER BEIGE

Lucidatura/Finishing/
Отделка/饰面
57. CHOCOLATE

Struttura in legno massello.
Parte esterna decorata a rombi.
Cuscini seduta e schienale
in poliuretano a quote
differenziate. Meccanismo per
divano letto non disponibile.

Solid wood frame. Quilted
outer body. Multiple densities
polyurethane foam seating and
backrest. Bed mechanism not
available.

Каркас из массива дерева.
Стеганая внешняя часть
корпуса. Пенополиуретан
разной плотности. Механизм
трансформации отсутствует.

实木框架。外侧部分绗缝。多
重密度聚氨酯泡沫。不可用作
沙发床。



GIASONE

MODULAR SOFA

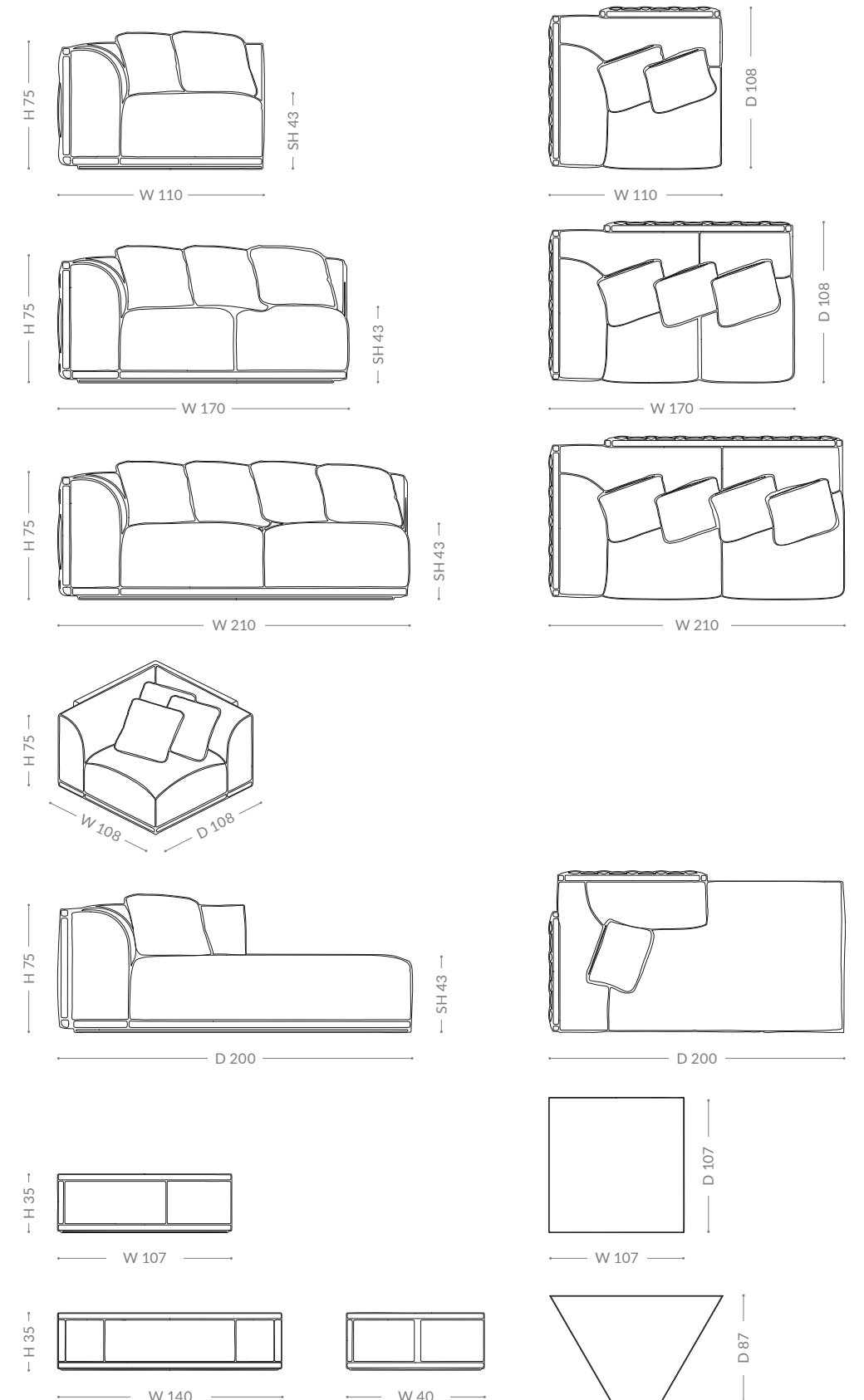

GIASONE Elemento laterale 1 posto/
Side element 1 seat/Боковой элемент
с 1 сиденьем/侧位组件 1 人位
2 cuscini inclusi
2 pillows included
2 подушки в комплекте
含 2 个抱枕

GIASONE Elemento laterale 2 posti/
Side element 2 seats/Боковой элемент
с 2 сиденьями/侧位组件 2 人位
3 cuscini inclusi
3 pillows included
3 подушки в комплекте
含 3 个抱枕

GIASONE Elemento laterale 3 posti/
Side element 3 seats/Боковой элемент
с 3 сиденьями/侧位组件 3 人位
4 cuscini inclusi
4 pillows included
4 подушки в комплекте
含 4 个抱枕

GIASONE Elemento d'angolo/Cor-
ner element/Угловой элемент/转
角组件
3 cuscini inclusi
3 pillows included
3 подушки в комплекте
含 3 个抱枕

GIASONE Dormeuse/Dormeuse/
Кушетка/沙发躺椅
1 cuscino incluso
1 pillow included
1 подушка в комплекте
含 1 个抱枕

GIASONE Tavolo quadrato/Corner
table/Угловой стол/角桌

GIASONE Tavolo trapezio/Angular
table/Многоугольный стол/棱角桌

GORDON

SOFA

Struttura in legno massello; basamento in legno di faggio. Parte interna trapuntata a righe verticali. Cuscini di seduta in vera piuma con inserto in poliuretano. Meccanismo per divano letto disponibile.

Solid wood frame; shaped beechwood base. Vertically decorated quilted inner body. Seat cushions in natural feather with polyurethane insert. Available with bed mechanism.

Каркас из массива дерева, фигурная основа из бука. Стеганая внутренняя часть корпуса имеет вертикальную отделку. Подушки сиденья наполнены натуральным пером и имеют полиуретановую прокладку. Есть механизм трансформации.

实木框架；山毛榉型材底座。内侧部分采用竖直装饰纹缝。坐垫填充天然羽毛和聚氨酯泡沫。可用作沙发床。



S O F A S

As picture: Gordon 3 seats
In price list: Prestige/Brilliant

Divano/Sofa/Диван/沙发
BZ 188-06 BOUCLÉ TEAL

Cuscini/Pillows/Подушки/抱枕
BZ 184-902 PALMA LIGHT BLUE/BRASS
BZ 188-06 BOUCLÉ TEAL

Lucidatura/Finishing/Отделка/饰面
55. COFFEE

GORDON
SOFA

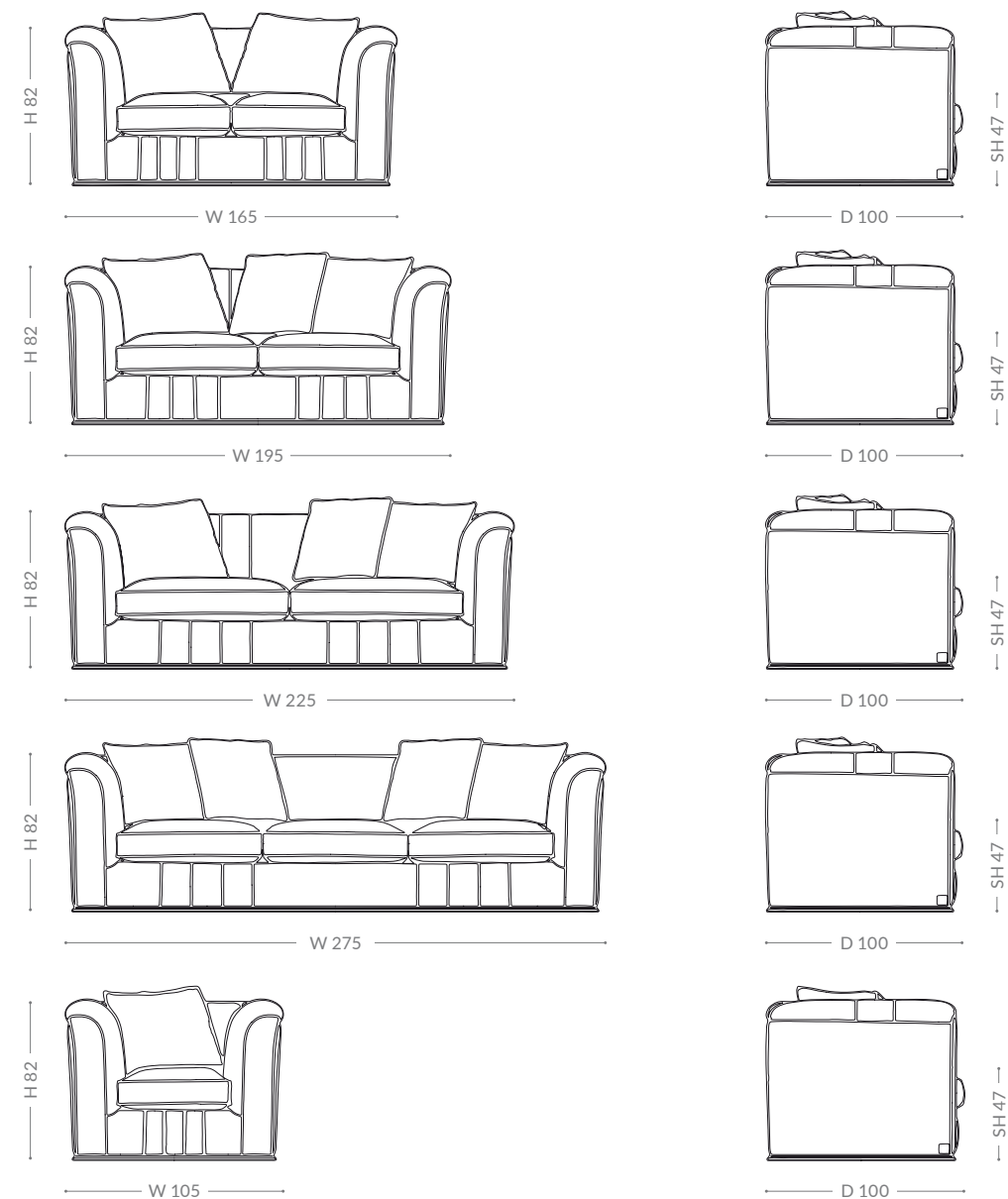

GORDON 2 Posti/Seats/Сиденья/
座位
2 cuscini inclusi
2 pillows included
2 подушки в комплекте
含 2 个抱枕

GORDON 2,5 Posti/Seats/Сиденья/
座位
3 cuscini inclusi
3 pillows included
3 подушки в комплекте
含 3 个抱枕

GORDON 3 Posti/Seats/Сиденья/
座位
3 cuscini inclusi
3 pillows included
3 подушки в комплекте
含 3 个抱枕

GORDON 4 Posti/Seats/Сиденья/
座位
4 cuscini inclusi
4 pillows included
4 подушки в комплекте
含 4 个抱枕

GORDON Poltrona/Armchair/
Кресло/扶手沙发椅
1 cuscino incluso
1 pillow included
1 подушка в комплекте
含 1 个抱枕

GORDON
MODULAR SOFA



As picture: Gordon modular
(side element cm 200 + dormeuse)
In price list: Prime/Brilliant

Divano/Sofa/Диван/沙发
BZ 187-127 VELVET SAND

Cuscini/Pillows/Подушки/抱枕
BZ 183-901 RAILING WHITE/GOLD
BZ 145-001 BOUCLÉ IVORY/BEIGE/GOLD
BZ 904-4632 LEATHER SAND

Lucidatura/Finishing/
Отделка/饰面
51. SAND

Struttura in legno massello; basamento in legno. Parte interna trapuntata a righe verticali. Cuscini di seduta in vera piuma con inserto in poliuretano. Meccanismo per divano letto disponibile.

Solid wood frame; shaped beechwood base. Vertically decorated quilted inner body. Seat cushions in natural feather with polyurethane insert. Available with bed mechanism.

Каркас из массива дерева, фигурная основа из бука. Стеганая внутренняя часть корпуса имеет вертикальную отделку. Подушки сиденья наполнены натуральным пером и имеют полиуретановую прокладку. Есть механизм трансформации.

实木框架；山毛榉型材底座。内侧部分采用竖直装饰纹缝。坐垫填充天然羽毛和聚氨酯泡沫。可用作沙发床。



GORDON

MODULAR SOFA

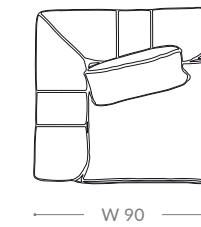
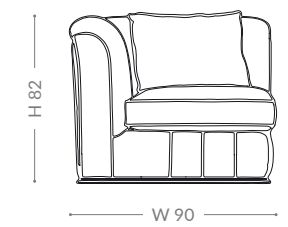

GORDON Elemento laterale 1 posto/
Side element 1 seat/Боковой элемент
с 1 сиденьем/侧位组件 1 人位
1 cuscino incluso
1 pillow included
1 подушка в комплекте
含 1 个抱枕

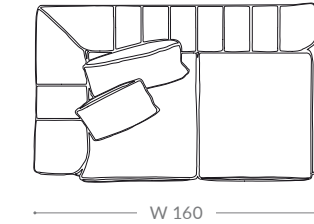
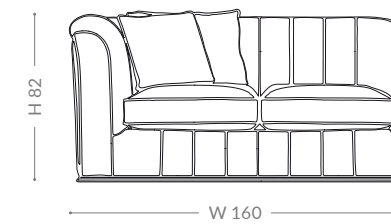

GORDON Elemento laterale 2 posti/
Side element 2 seats/Боковой элемент
с 2 сиденьями/侧位组件 2 人位
2 cuscini inclusi
2 pillows included
2 подушки в комплекте
含 2 个抱枕

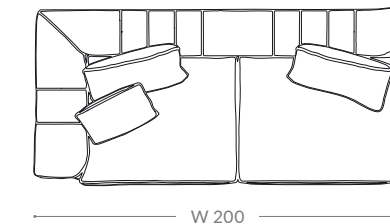
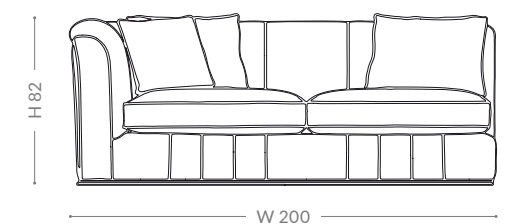

GORDON Elemento laterale 3 posti/
Side element 3 seats/Боковой элемент
с 3 сиденьями/侧位组件 3 人位
3 cuscini inclusi
3 pillows included
3 подушки в комплекте
含 3 个抱枕

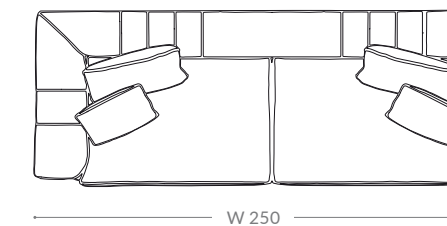
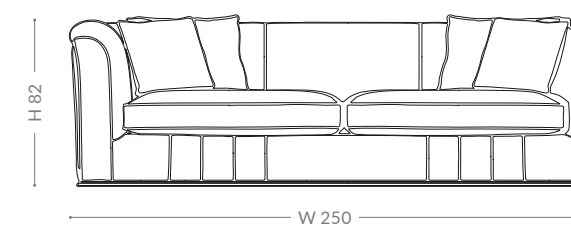

GORDON Elemento laterale 4 posti/
Side element 4 seats/Боковой элемент
с 4 сиденьями/侧位组件 4 人位
4 cuscini inclusi
4 pillows included
4 подушки в комплекте
含 4 个抱枕

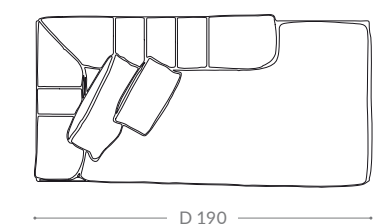
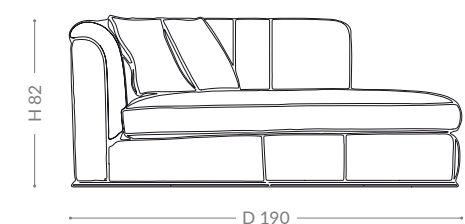

GORDON Dormeuse/Dormeuse/
Кухетка/沙发躺椅
2 cuscini inclusi
2 pillows included
2 подушки в комплекте
含 2 个抱枕

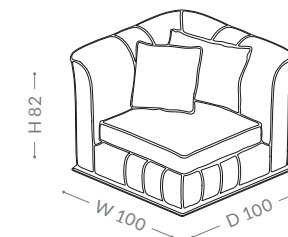

GORDON Elemento d'angolo/
Corner element/Угловой элемент/转角组件
2 cuscini inclusi
2 pillows included
2 подушки в комплекте
含 2 个抱枕

HARMONY

SOFA



S O F A S

As picture: Harmony 3 seats
In price list: Prestige/Brilliant

Divano/Sofa/Диван/沙发
BZ 216-120 VELVET RHUBARB

Cuscini/Pillows/Подушки/抱枕
BZ 210-02 PLUM FLOWER

Lucidatura/Finishing/Отделка/饰面
57. CHOCOLATE
69. CANALETTO WALNUT

Struttura in legno massello;
basamento in noce canaletto.
Cuscini seduta e schienale
in poliuretano a quote
differenziate. Meccanismo per
divano letto non disponibile.

Solid wood frame; canaletto
walnut wooden base. Multiple
densities polyurethane foam
seating and backrest. Bed
mechanism not available.

Каркас из массива дерева,
деревянная основа из ореха
каналетто. Пенополиуретан
разной плотности. Механизм
трансформации отсутствует.

实木框架；卡纳莱托胡桃木底
座。多重密度聚氨酯泡沫。不
可用作沙发床。

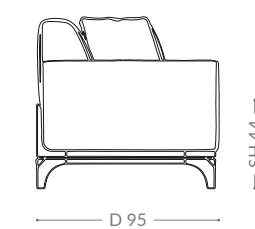
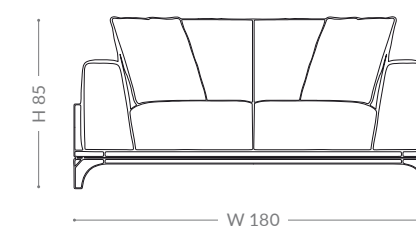

HARMONY 2 Posti/Seats/Сиденья/
座位
2 cuscini inclusi
2 pillows included
2 подушки в комплекте
含 2 个抱枕

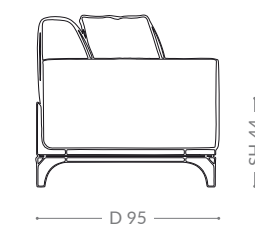
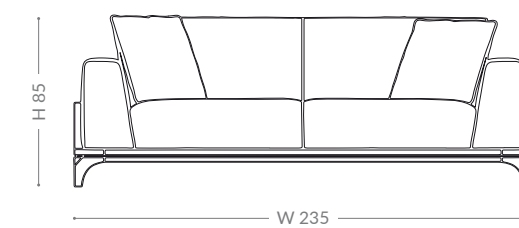

HARMONY 3 Posti/Seats/Сиденья/
座位
2 cuscini inclusi
2 pillows included
2 подушки в комплекте
含 2 个抱枕

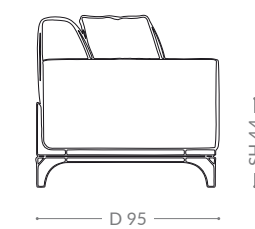
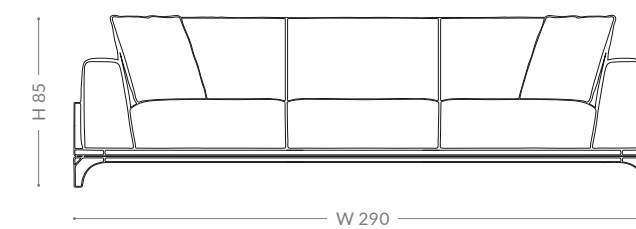

HARMONY 4 Posti/Seats/Сиденья/
座位
2 cuscini inclusi
2 pillows included
2 подушки в комплекте
含 2 个抱枕

HEMINGWAY

SOFA



Struttura in legno massello; piedini in legno di faggio. Seduta e schienale in poliuretano a quote differenziate. Meccanismo per divano letto non disponibile.

Solid wood frame; beechwood feet. Multiple densities polyurethane foam seating and backrest. Bed mechanism not available.

Каркас из массива дерева, ножки из бука. Пенополиуретан разной плотности. Механизм трансформации отсутствует.

实木框架；山毛榉沙发脚。多重密度聚氨酯泡沫。不可用作沙发床。



S O F A S

As picture: Hemingway 3 seats
In price list: Ambition/Brilliant

Divano/Sofa/Диван/沙发
BZ 901-702 LEATHER DOVE GREY

Cuscini/Pillows/Подушки/抱枕
BZ 206-09 BOUCLÉ PEBBLE

Lucidatura/Finishing/Отделка/饰面
54. GREY

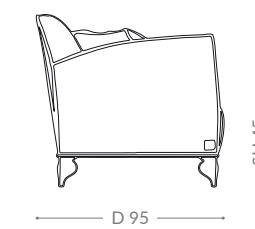
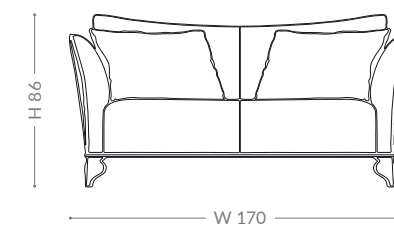

HEMINGWAY 2 Posti/Seats/
Сиденья/座位
2 cuscini inclusi
2 pillows included
2 подушки в комплекте
含 2 个抱枕

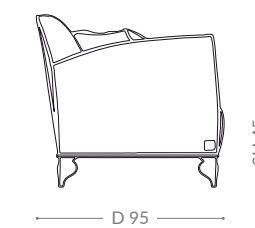
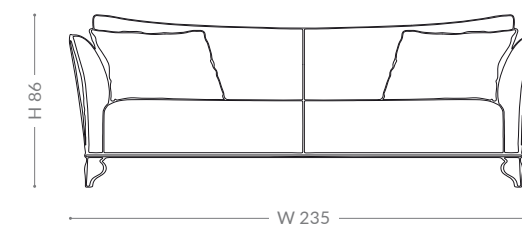

HEMINGWAY 3 Posti/Seats/
Сиденья/座位
2 cuscini inclusi
2 pillows included
2 подушки в комплекте
含 2 个抱枕

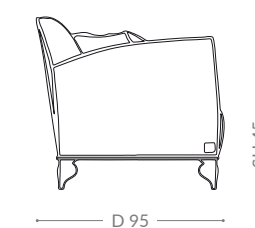
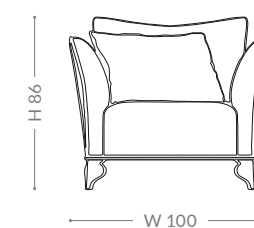

HEMINGWAY Poltrona/Armchair/
Кресло/扶手沙发椅
1 cuscino incluso
1 pillow included
1 подушка в комплекте
含 1 个抱枕

IPAZIA

SOFA



Struttura in legno massello; basamento in legno di faggio. Cuscini di seduta e schienale in poliuretano a quote differenziate. Parte esterna e poggiatesta ricamati. Meccanismo per divano letto non disponibile.

Solid wood frame; beechwood base. Multiple densities polyurethane foam seating and backrest. Quilted outer body and headrest. Bed mechanism not available.

Каркас из массива дерева, основа из бука. Сиденье и спинка наполнены пенополиуретаном разной плотности. Стеганый внешняя часть и подголовник. Механизм трансформации отсутствует.

实木框架；山毛榉底座。座位和靠背填充多重密度聚氨酯泡沫。绗缝外部和头枕。床机制不可用。

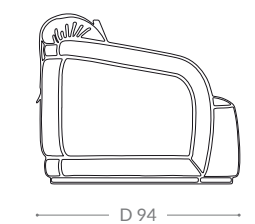
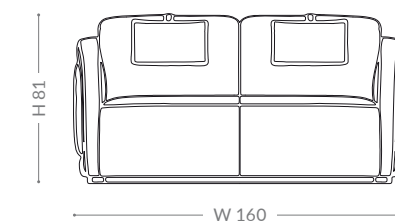

IPAZIA 2 Posti/Seats/Сиденья/座位
0 cuscini inclusi
0 pillows included
0 подушки в комплекте
含 0 个抱枕

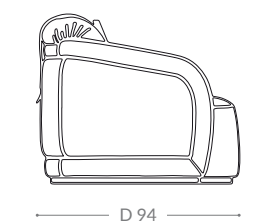
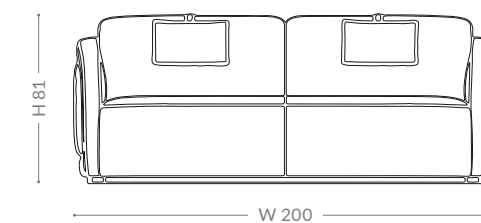

IPAZIA 3 Posti/Seats/Сиденья/座位
0 cuscini inclusi
0 pillows included
0 подушки в комплекте
含 0 个抱枕

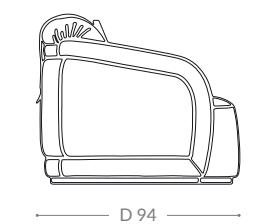
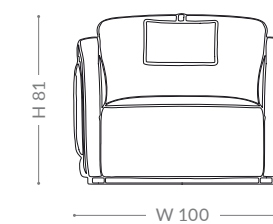

IPAZIA Poltrona/Armchair/Кресло/扶手沙发椅
0 cuscini inclusi
0 pillows included
0 подушки в комплекте
含 0 个抱枕

S O F A S

As picture: Ipaż a 3 seats
In price list: Prestige/Brilliant

Divano/Sofa/Диван/沙发
BZ 126-51 UNITO GREY/PEARL
BZ 901-702 LEATHER DOVE GREY

Lucidatura/Finishing/Отделка/饰面
54. GREY

Parti in metallo/Metal parts/Металлическая фурнитура/金属部件
TITANIUM

KING

SOFA



Struttura in legno massello; piedini in ottone. Parte interna trapuntata a quadrati e bottoni. Cuscini di seduta in vera piuma con inserto in poliuretano. Meccanismo per divano letto non disponibile.

Solid wood frame; brass feet. Quilted inner body with buttons. Seat cushions in natural feather with polyurethane insert. Bed mechanism not available.

Каркас из массива дерева, ножки из латуни. Стеганая внутренняя часть корпуса с пуговицами. Подушки сиденья наполнены натуральным пером и имеют полиуретановую прокладку. Механизм трансформации отсутствует.

实木框架；黄铜沙发脚。绗缝内侧部分（带纽扣）。坐垫填充天然羽毛和聚氨酯泡沫。不可用作沙发床。



S O F A S

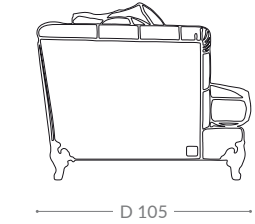
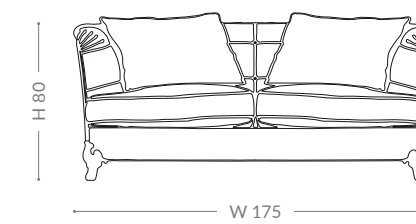

KING 2 Posti/Seats/Сиденья/座位
2 cuscini inclusi
2 pillows included
2 подушки в комплекте
含 2 个抱枕

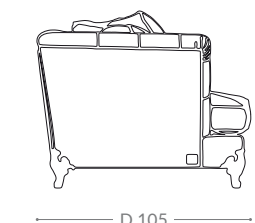
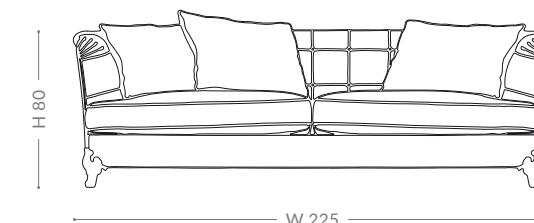

KING 3 Posti/Seats/Сиденья/座位
3 cuscini inclusi
3 pillows included
3 подушки в комплекте
含 3 个抱枕

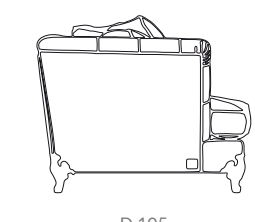
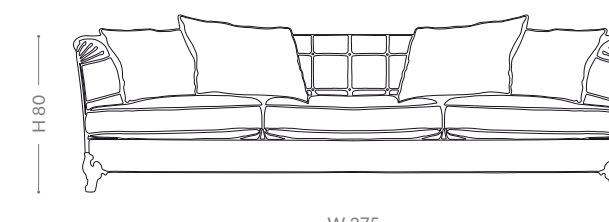

KING 4 Posti/Seats/Сиденья/座位
4 cuscini inclusi
4 pillows included
4 подушки в комплекте
含 4 个抱枕

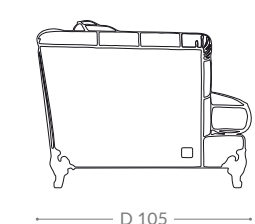
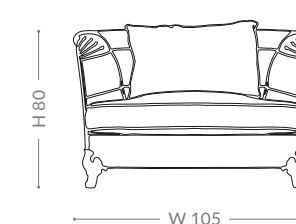

KING Poltrona/Armchair/Кресло/扶手沙发椅
1 cuscino incluso
1 pillow included
1 подушка в комплекте
含 1 个抱枕

As picture: King 3 seats
In price list: Prestige

Divano/Sofa/Диван/沙发
BZ 220-02 VELVET IVORY

Cuscini/Pillows/Подушки/抱枕
BZ 132-004 BOUCLÉ IVORY/GOLD
BZ 135-004 VELVET GALUCHAT GOLD

Parti in metallo/Metal parts/Металлическая фурнитура/金属部件
GOLD

LEGEND

SOFA

Struttura in legno massello. Gambe frontali in legno di faggio con decorazioni in ottone. Parte interna ricamata; schienale con decorazione a corsetto. Cuscini di seduta in vera piuma con inserto in poliuretano. Meccanismo per divano letto non disponibile.

Solid wood frame. Beechwood front legs with brass decoration. Quilted backrest; outer body with corset decoration. Seat cushions in natural feather with polyurethane insert. Bed mechanism not available.

Каркас из массива дерева. Передние ножки из бука украшены элементами из латуни. Стеганая спинка, внешняя часть корпуса с корсетной отделкой. Подушки сиденья наполнены натуральным пером и имеют полиуретановую прокладку. Механизм трансформации отсутствует.

实木框架。山毛榉沙发脚（前脚）采用黄铜装饰。绗缝靠背；外侧部分采用交叉系绳装饰。坐垫填充天然羽毛和聚氨酯泡沫。不可用作沙发床。



S O F A S

As picture: Legend 3 seats
In price list: Prime/Brilliant

Divano/Sofa/Диван/沙发
BZ 901-332 LEATHER BUTTER
BZ 156-417 VELVET IVORY

Cuscini/Pillows/Подушки/抱枕
BZ 126-52 UNITO IVORY
Lucidatura/Finishing/Отделка/饰面
50. IVORY

Parti in metallo/Metal parts/Металлическая фурнитура/金属部件
GOLD

LEGEND

SOFA



S O F A S

As picture: Legend 3 seats
In price list: Ambition/Brilliant

Divano/Sofa/Диван/沙发
BZ 901-632 LEATHER LIGHT BROWN

Cuscini/Pillows/Подушки/抱枕
BZ 188-07 BOUCLÉ SAND
Lucidatura/Finishing/Отделка/饰面
55. COFFEE

Parti in metallo/Metal parts/Металлическая фурнитура/金属部件
TITANIUM

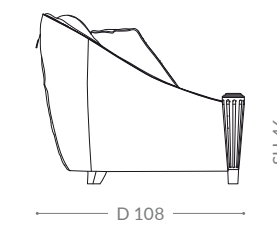
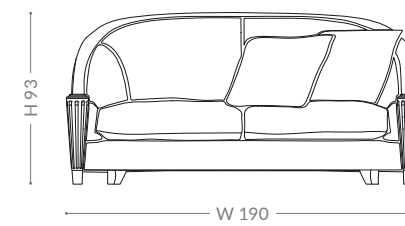

LEGEND 2 Posti/Seats/Сиденья/座位
2 cuscini inclusi
2 pillows included
2 подушки в комплекте
含 2 个抱枕

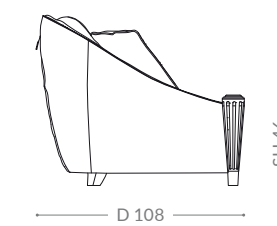
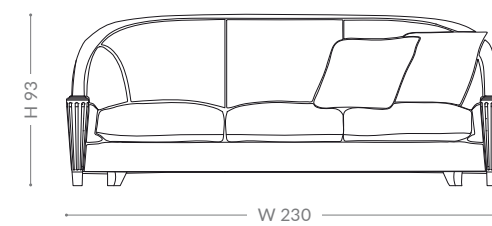

LEGEND 3 Posti/Seats/Сиденья/座位
2 cuscini inclusi
2 pillows included
2 подушки в комплекте
含 2 个抱枕

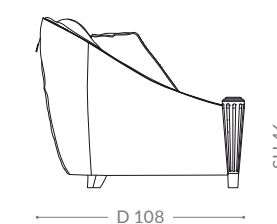
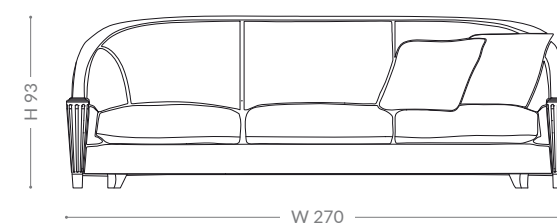

LEGEND 4 Posti/Seats/Сиденья/座位
2 cuscini inclusi
2 pillows included
2 подушки в комплекте
含 2 个抱枕

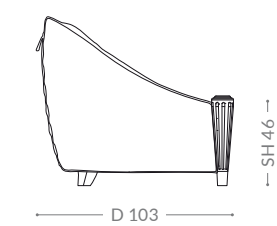
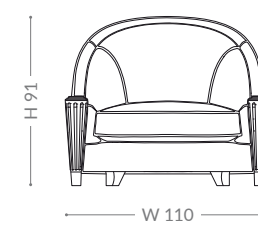

LEGEND Poltrona/Armchair/
Кресло/扶手沙发椅
0 cuscini inclusi
0 pillows included
0 подушки в комплекте
含 0 个抱枕

POSEIDON

SOFA



Struttura in legno massello; basamento in legno di faggio. Parte esterna ricamata. Cuscini di seduta e schienale in poliuretano a quote differenziate. Meccanismo per divano letto non disponibile.

Solid wood frame; beechwood base. Quilted outer body. Multiple densities polyurethane foam. Bed mechanism not available.

Каркас из массива дерева, основа из бука. Стеганая внешняя часть корпуса. Пенополиуретан разной плотности. Механизм трансформации отсутствует.

实木框架；山毛榉底座。外侧部分绗缝。多重密度聚氨酯泡沫。不可用作沙发床。



Parti in metallo/Metal parts/Металлическая фурнитура/金属部件
GOLD

As picture: Poseidon 4 seats
In price list: Prime/Brilliant

Divano/Sofa/Диван/沙发
BZ 187-127 VELVET SAND
BZ 901-891 LEATHER IVORY

Cuscini/Pillows/Подушки/抱枕
BZ 901-891 LEATHER IVORY
BZ 184-901 PALMA BEIGE/IVORY

Lucidatura/Finishing/Отделка/饰面
51. SAND

POSEIDON

SOFA



S O F A S

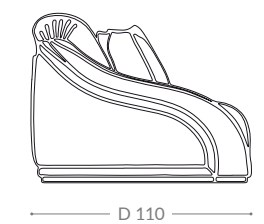
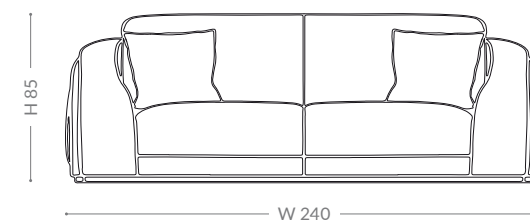

POSEIDON 3 Posti/Seats/Сиденья/
座位
2 cuscini inclusi
2 pillows included
2 подушки в комплекте
含 2 个抱枕

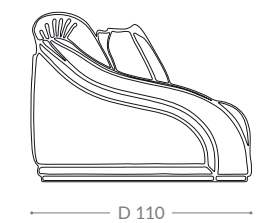
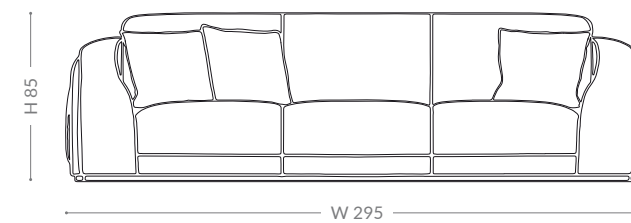

POSEIDON 4 Posti/Seats/Сиденья/
座位
3 cuscini inclusi
3 pillows included
3 подушки в комплекте
含 3 个抱枕

As picture: Poseidon 4 seats
In price list: Exclusive

Divano/Sofa/Диван/沙发
BZ 203-009 BOUCLÉ BLUE
BZ 905-5049 LEATHER DARK BLUE

Cuscini/Pillows/Подушки/抱枕
BZ 200-802 VELVET BLUE
Lucidatura/Finishing/Отделка/饰面
85. CHOCOLATE MATT

Parti in metallo/Metal parts/Метал-
лическая фурнитура/金属部件
TITANIUM

VERTIGO

SOFA

Struttura in legno massello. Cornici in legno di noce canaletto. Schienale trapuntato. Cuscini di seduta in vera piuma con inserto in poliuretano. Braccioli esterni in pelle ricamata o con mosaico su richiesta. Meccanismo per divano letto non disponibile.

Solid wood structure; canaletto walnut wooden frames. Quilted backrest. Seat cushions in natural feather with polyurethane insert. External armrests in quilted leather (alternatively with mosaic on request). Bed mechanism not available.

Конструкция из массива дерева, деревянные каркасы из ореха каналетто. Стеганая спинка. Подушки сиденья наполнены натуральным пером и имеют полиуретановую прокладку. Внешняя часть подлокотников выполнена из стеганой кожи (украшение из мозаики выполняется по заказу). Механизм трансформации отсутствует.

实木结构；卡纳莱托胡桃木框架。绗缝靠背。坐垫填充天然羽毛和聚氨酯泡沫。扶手外侧为绗缝皮革（也可根据要求镶嵌图案）。不可用作沙发床。



S O F A S

As picture: Vertigo 4 seats
In price list: Ambition/Brilliant/
Twin mosaic on request

Divano/Sofa/Диван/沙发
BZ 906-2006 LEATHER TAUPE
MOSAIC DECORATION

Cuscini/Pillows/Подушки/抱枕
BZ 203-004 BOUCLÉ TIFFANY

Lucidatura/Finishing/Отделка/饰面
69. CANALETTO WALNUT

VERTIGO

SOFA



S O F A S

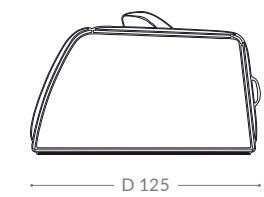
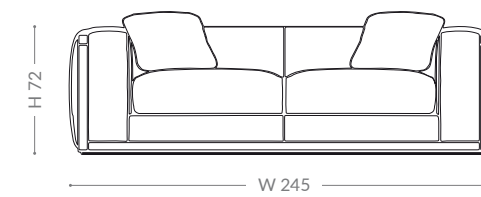

VERTIGO 3 Posti/Seats/Сиденья/座位
2 cuscini inclusi
2 pillows included
2 подушки в комплекте
含 2 个抱枕

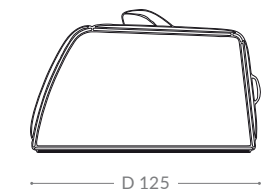
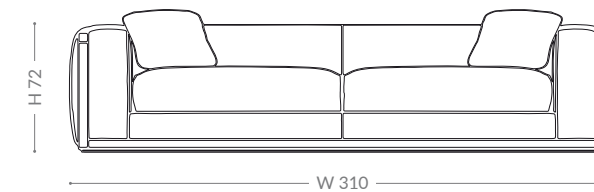

VERTIGO 4 Posti/Seats/Сиденья/座位
2 cuscini inclusi
2 pillows included
2 подушки в комплекте
含 2 个抱枕

As picture: Vertigo 3 seats
In price list: Ambition/Brilliant

Divano/Sofa/Диван/沙发
BZ 906-2005 LEATHER OASI

Cuscini/Pillows/Подушки/抱枕
BZ 218-206 VELVET CARVED BROWN

Lucidatura/Finishing/Отделка/饰面
69. CANALETTO WALNUT

WAVE

SOFA



Struttura in legno massello. Piedini e anello braccioli in metallo oro martellato. Esterno braccioli in pelle ricamata. Cuscini di seduta e schienale in vera piuma con inserto in poliuretano. Meccanismo per divano letto non disponibile.

Solid wood frame. Feet and armrests decoration in hammered gold metal. Leather decoration on outer armrests. Seat and back cushions in natural feather with polyurethane insert. Bed mechanism not available.

Каркас из массива дерева. Ножки и подлокотники украшены чеканным золотистым металлом. Кожаная отделка внешней части подлокотников. Подушки сиденья и спинки наполнены натуральным пером и имеют полиуретановую прокладку. Механизм трансформации отсутствует.

实木框架。沙发脚和扶手采用金色锻造金属装饰。扶手外侧采用皮革装饰。坐垫和靠背填充天然羽毛和聚氨酯泡沫。不可用作沙发床。



S O F A S

As picture: Wave 3 seats
In price list: Ambition

Divano/Sofa/Диван/沙发
BZ 905-5230 LEATHER GREY

Cuscini/Pillows/Подушки/抱枕
BZ 192-003 CHEVRON GREY

Parti in metallo/Metal parts/Металлическая фурнитура/金属部件
HAMMERED GOLD

WAVE
SOFA

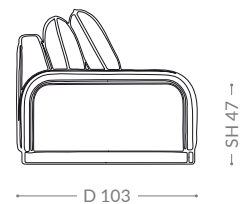
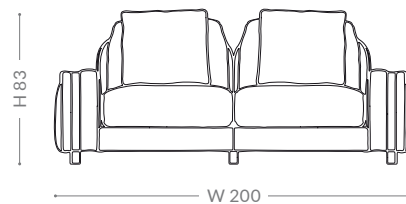

WAVE 2 Posti/Seats/Сиденья/座位
2 cuscini inclusi
2 pillows included
2 подушки в комплекте
含 2 个抱枕

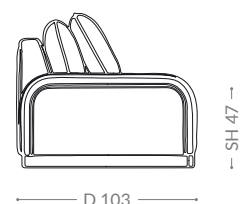
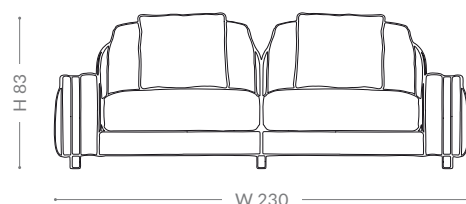

WAVE 2,5 Posti/Seats/Сиденья/座位
2 cuscini inclusi
2 pillows included
2 подушки в комплекте
含 2 个抱枕

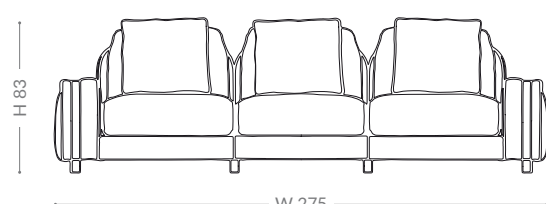

WAVE 3 Posti/Seats/Сиденья/座位
3 cuscini inclusi
3 pillows included
3 подушки в комплекте
含 3 个抱枕

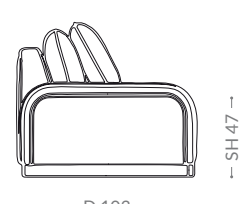
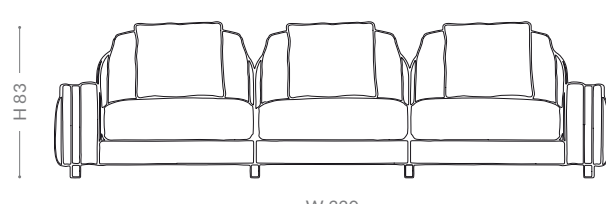

WAVE 4 Posti/Seats/Сиденья/座位
3 cuscini inclusi
3 pillows included
3 подушки в комплекте
含 3 个抱枕

WAVE
MODULAR SOFA



As picture: Wave modular (2 side elements with arm cm 100 + 4 single elements cm 75 + corner table)
In price list: Prime

Divano/Sofa/Диван/沙发
BZ 206-11 BOUCLÉ SANDSTONE
BZ 906-2023 LEATHER CARAMEL

Cuscini/Pillows/Подушки/抱枕
BZ 208-0416 LEAF TAUPE
Lucidatura/Finishing/Отделка/饰面
93. WENGÉ MATT
100. GREY MATT

Parti in metallo/Metal parts/
Металлическая фурнитура/
金属部件
HAMMERED GOLD

Struttura in legno massello. Piedini e anello braccioli in metallo oro martellato. Esterno braccioli in pelle ricamata. Cuscini di seduta e schienale in vera piuma con inserto in poliuretano. Meccanismo per divano letto non disponibile.

Solid wood frame. Feet and armrests decoration in hammered gold metal. Leather decoration on outer armrests. Seat and back cushions in natural feather with polyurethane insert. Bed mechanism not available.

Каркас из массива дерева. Ножки и подлокотники украшены чеканным золотистым металлом. Кожаная отделка внешней части подлокотников. Подушки сиденья и спинки наполнены натуральным пером и имеют полиуретановую прокладку. Механизм трансформации отсутствует.

实木框架。沙发脚和扶手采用金色锻造金属装饰。扶手外侧采用皮革装饰。坐垫和靠背填充天然羽毛和聚氨酯泡沫。不可用作沙发床。



WAVE
MODULAR SOFA

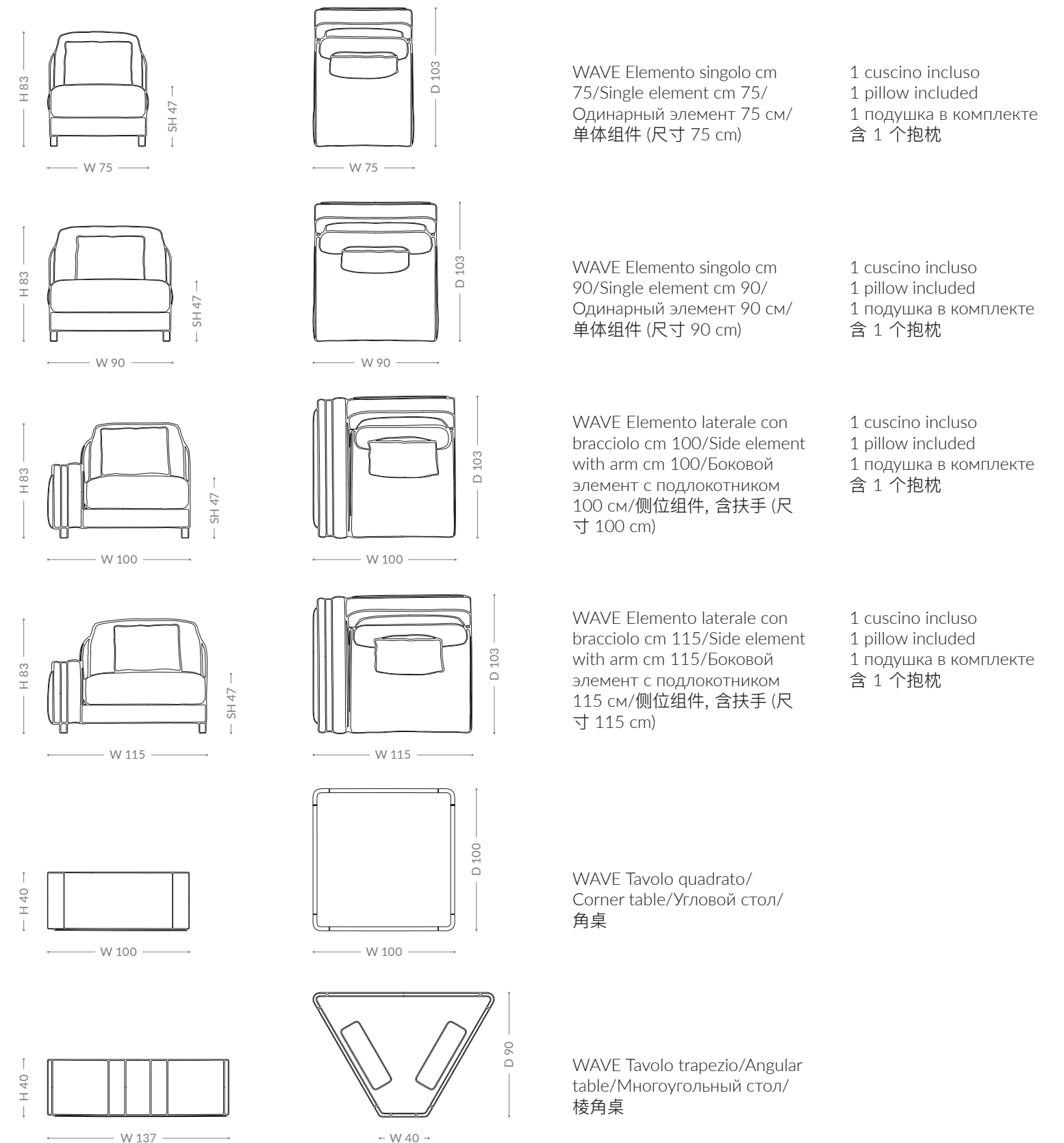

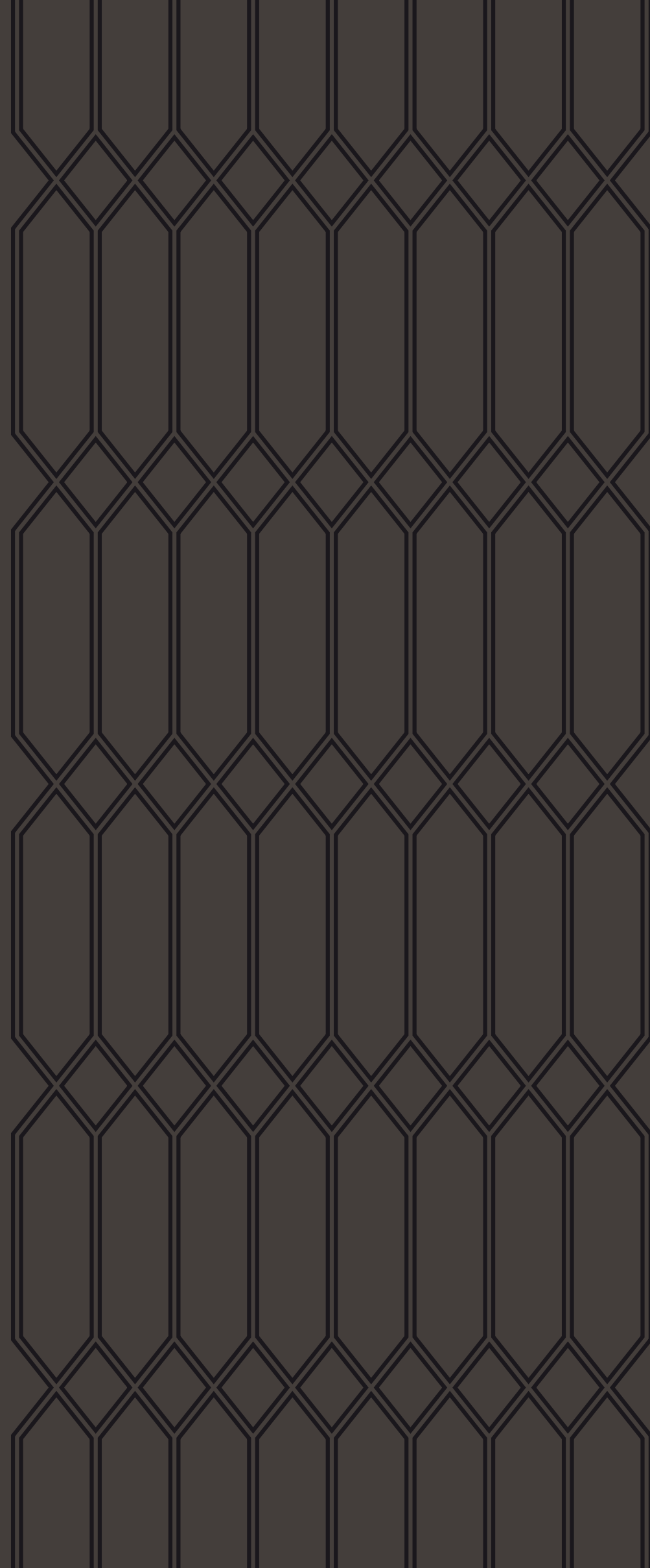

ZB

ARMCHAIRS



ARDEA

ARMCHAIR

Struttura in multistrati di legno sagomato; telaio in metallo. Parte esterna ricamata. Seduta in poliuretano a quote differenziate.

Plywood shaped structure; metal frame. Quilted outer body. Multiple densities polyurethane foam seating.

Фигурная конструкция из фанеры, металлический каркас. Стеганая внешняя часть корпуса. Сиденье наполнено пенополиуретаном разной плотности.

胶合板型材结构；金属框架。外侧部分绗缝。座位填充多重密度聚氨酯泡沫。



As picture: Ardea armchair
In price list: Ambition

Poltrona/Armchair/Кресло/扶手沙发椅
BZ 906-2030 LEATHER BURGUNDY

Lucidatura/Finishing/Отделка/饰面
GOLD

ARDEA

ARMCHAIR



ARMCHAIRS

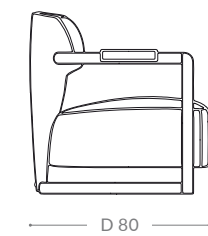
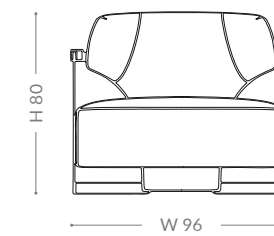

As picture: Ardea armchair
In price list: Exclusive

Poltrona/Armchair/Кресло/扶手沙发椅
BZ 218-206 VELVET CARVED BROWN
BZ 906-2003 LEATHER DARK BROWN

Lucidatura/Finishing/Отделка/饰面
TITANIUM

ARIEL

ARMCHAIR



Struttura in legno massello.
Piedini in noce canaletto.
Schienale e parte esterna con
ricamo. Cuscino di seduta in
vera piuma con inserto in
poliuretano.

Solid wood frame. Canaletto
walnut wooden feet. Quilted
backrest and outer body. Seat
cushions in natural feather
with polyurethane insert.

Каркас из массива дерева.
Деревянные ножки из ореха
каналетто. Стеганные спинка
и внешняя часть корпуса.
Подушки сиденья наполнены
натуральным пером и имеют
полиуретановую прокладку.

实木框架。卡纳莱托胡桃木沙
发脚。绗缝靠背和外侧部分。
坐垫填充天然羽毛和聚氨酯泡
沫。

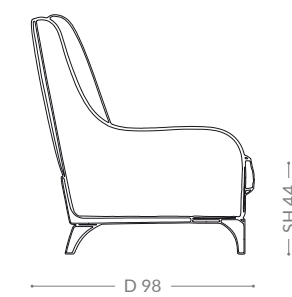
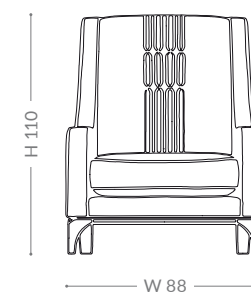

As picture: Ariel armchair
In price list: Exclusive/Brilliant

Poltrona/Armchair/Кресло/扶手沙发椅
BZ 203-004 BOUCLÉ TIFFANY
BZ 906-2006 LEATHER TAUPE

Lucidatura/Finishing/Отделка/饰面
70. CANALETTO WALNUT MATT
54. GREY

AURORA

ARMCHAIR



Struttura in legno massello; finitura con borchie in pelle. Cuscino di seduta in vera piuma con inserto in poliuretano.

Solid wood frame; finished with leather covered nails. Seat cushions in natural feather with polyurethane insert.

Каркас из массива дерева, отделка из декоративных гвоздей с кожаной шляпкой. Подушки сиденья наполнены натуральным пером и имеют полиуретановую прокладку.

实木框架；采用皮革镶钉装饰。坐垫填充天然羽毛和聚氨酯泡沫。

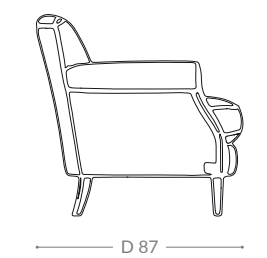
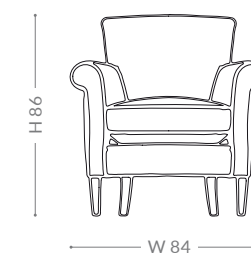

ARMCHAIRS

As picture: Aurora armchair
In price list: Ambition/Brilliant

Poltrona/Armchair/Кресло/扶手沙发椅
BZ 901-965 LEATHER BLACK

Lucidatura/Finishing/Отделка/饰面
58. BLACK

Parti in metallo/Metal parts/Металлическая фурнитура/金属部件
TITANIUM

BAUHAUS

ARMCHAIR



Struttura in legno massello. Schienale esterno in listellare/MDF con lavorazione verticale e decorazione in legno applicata sul perimetro. Schienale trapuntato a rombi con bottoni. Cuscini di seduta in vera piuma con inserto in poliuretano.

Solid wood frame. Outer body in blockboard/MDF with fluted decoration. Wooden elements applied on the edge. Quilted backrest with buttons. Seat cushions in natural feather with polyurethane insert.

Каркас из массива дерева. Внешняя часть корпуса выполнена из столлярной плиты/МДФ с рельефной отделкой. Края украшены деревянными элементами. Стеганая спинка с пуговицами. Подушки сиденья наполнены натуральным пером и имеют полиуретановую прокладку.

实木框架。外侧部分为带凹槽装饰的细木工板/中密度纤维板。沙发边缘镶嵌木制组件。绗缝靠背（带纽扣）。坐垫填充天然羽毛和聚氨酯泡沫。

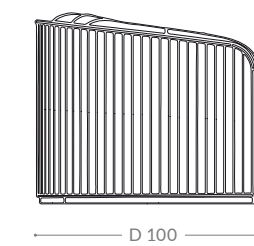
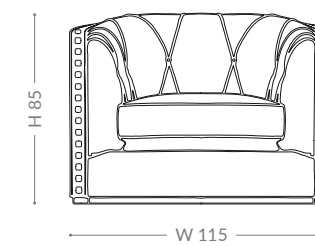

As picture: Bauhaus armchair
In price list: Prestige/Brilliant

Poltrona/Armchair/Кресло/扶手沙发椅
BZ 126-51 UNITO GREY/PEARL

Lucidatura/Finishing/Отделка/饰面
53. DOVE GREY

BEVERLY

ARMCHAIR



Struttura in legno massello e multistrati di faggio; basamento in metallo. Inserto ricamato su schiena e seduta. Cuscini in poliuretano a quote differenziate.

Solid wood frame; plywood beechwood. Metal base. Quilted backrest and seating. Multiple densities polyurethane foam cushions.

Каркас из массива дерева, фанера из бука. Металлическая основа. Стеганные спинка и сиденье. Пенополиуретан разной плотности.

实木框架；山毛榉胶合板。金属底座。绗缝靠背和座位。多重密度聚氨酯泡沫。



As picture: Beverly armchair
In price list: Ambition

Poltrona/Armchair/Кресло/扶手沙发椅
BZ 901-891 LEATHER IVORY

Parti in metallo/Metal parts/Металлическая фурнитура/金属部件
TITANIUM

BEVERLY

ARMCHAIR



ARMCHAIRS

As picture: Beverly armchair
In price list: Ambition

Poltrona/Armchair/Кресло/扶手沙发椅
BZ 905-5103 LEATHER LOBSTER

Parti in metallo/Metal parts/Металлическая фурнитура/金属部件
GOLD

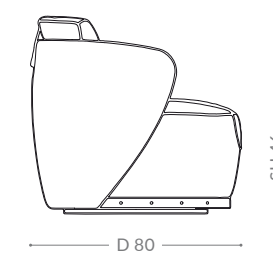
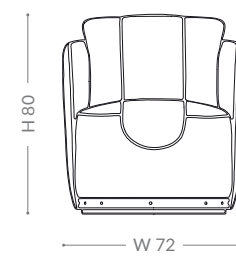

CLUB

ARMCHAIR



Struttura in legno massello. Piedini in legno intagliati a mano; parte esterna in legno multistrati decorata con traforo. Cuscini di seduta e schienale in poliuretano a quote differenziate.

Solid wood frame. Hand-carved wooden feet; fretwork plywood outer frame. Multiple densities polyurethane foam seating and backrest.

Каркас из массива дерева. Деревянные ножки ручной работы, наружный резной каркас из фанеры. Сиденье и спинка наполнены пенополиуретаном разной плотности.

实木框架。木制沙发脚采用手工雕刻；外框采用浮雕胶合板。座位和靠背填充多重密度聚氨酯泡沫。

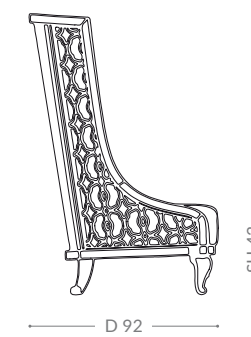
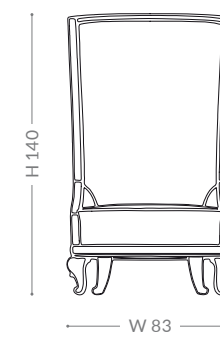

As picture: Club armchair
In price list: Supreme/Brilliant

Poltrona/Armchair/Кресло/扶手沙发椅
BZ 902-N8409 NABUK LIGHT BROWN

Lucidatura/Finishing/Отделка/饰面
57. CHOCOLATE

CLUB WIDE

ARMCHAIR



Struttura in legno massello. Piedini in legno intagliati a mano; parte esterna in legno multistrati decorata con traforo. Cuscini di seduta e schienale in vera piuma con inserto in poliuretano.

Solid wood frame. Hand-carved wooden feet; fretwork plywood outer frame. Seat and back cushions in natural feather with polyurethane insert.

Каркас из массива дерева. Деревянные ножки ручной работы, наружный резной каркас из фанеры. Подушки сиденья и спинки наполнены натуральным пером и имеют полиуретановую прокладку.

实木框架；木制底座。分块铆钉装饰（靠背和扶手）。坐垫填充天然羽毛和聚氨酯泡沫。

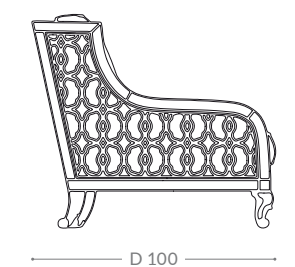
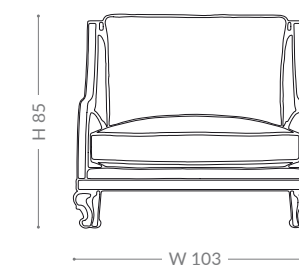

As picture: Club Wide armchair
In price list: Prime/Brilliant

Poltrona/Armchair/Кресло/扶手沙发椅
BZ 206-09 BOUCLÉ PEBBLE
BZ 901-702 LEATHER DOVE GREY

Lucidatura/Finishing/Отделка/饰面
54. GREY

DAVIS

ARMCHAIR

Struttura in legno massello; basamento in legno di faggio. Schienale e braccioli capitonné. Cuscini di seduta in vera piuma con inserto in poliuretano.

Solid wood frame; wooden base. Capitonné backrest and armrests. Seat cushions in natural feather with polyurethane insert.

Каркас из массива дерева, деревянная основа. Спинка и подлокотники с обивкой в виде каретной стяжки. Подушки сиденья наполнены натуральным пером и имеют полиуретановую прокладку.

实木框架；木制底座。分块铆钉装饰（靠背和扶手）。坐垫填充天然羽毛和聚氨酯泡沫。



ARMCHAIRS

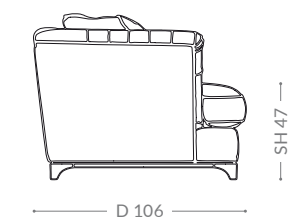
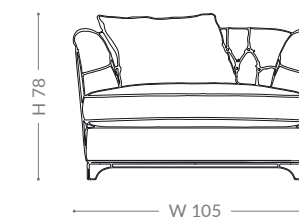

1 cuscino incluso
1 pillow included
1 подушка в комплекте
含 1 个抱枕

As picture: Davis armchair
In price list: Ambition/Brilliant

Poltrona/Armchair/Кресло/扶手沙发椅
BZ 901-965 LEATHER BLACK

Cuscini/Pillows/Подушки/抱枕
BZ 137-0678 BOUCLÉ BLACK/BEIGE

Lucidatura/Finishing/Отделка/饰面
58. BLACK

DAVIS SMALL

ARMCHAIR



Struttura in legno massello; basamento in legno di faggio. Schienale e braccioli capitonné. Cuscini di seduta in vera piuma con inserto in poliuretano.

Solid wood frame; wooden base. Capitonné backrest and armrests. Seat cushions in natural feather with polyurethane insert.

Каркас из массива дерева, деревянная основа. Спинка и подлокотники с обивкой в виде каретной стяжки. Подушки сиденья наполнены натуральным пером и имеют полиуретановую прокладку.

实木框架；木制底座。分块铆钉装饰（靠背和扶手）。坐垫填充天然羽毛和聚氨酯泡沫。

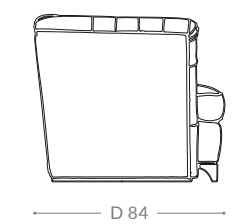
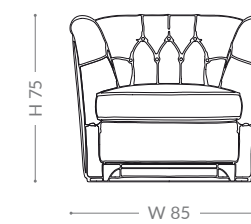

As picture: Davis Small armchair
In price list: Prime/Brilliant

Poltrona/Armchair/Кресло/扶手沙发椅
BZ 221-03 UNITO IVORY/CREAM

Lucidatura/Finishing/Отделка/饰面
51. SAND

FLOWER

ARMCHAIR



Struttura in legno massello; piedini in legno intagliati a mano. Cuscino di seduta in poliuretano a quote differenziate.

Solid wood frame. Hand-carved wooden feet. Multiple densities polyurethane foam seating.

Каркас из массива дерева. Деревянные ножки ручной работы. Сиденье наполнено пенополиуретаном разной плотности.

实木框架。手工雕刻木制沙发脚。座位填充多重密度聚氨酯泡沫。

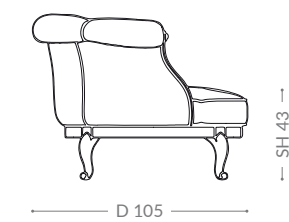
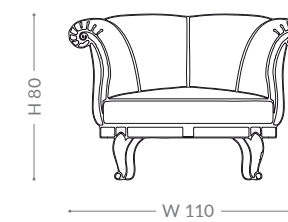

ARMCHAIRS

As picture: Flower armchair
In price list: Prime/Brilliant

Poltrona/Armchair/Кресло/扶手沙发椅
BZ 187-127 VELVET SAND

Lucidatura/Finishing/Отделка/饰面
57. CHOCOLATE

FLY
ARMCHAIR



Struttura in legno massello; basamento in legno di faggio sagomato. Cuscini di seduta in vera piuma con inserto in poliuretano.

Solid wood frame; shaped beechwood base. Seat cushions in natural feather with polyurethane insert.

Каркас из массива дерева, фигурная основа из бука. Подушки сиденья наполнены натуральным пером и имеют полиуретановую прокладку.

实木框架；山毛榉型材底座。坐垫填充天然羽毛和聚氨酯泡沫。

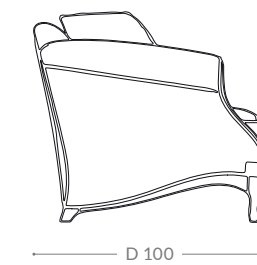
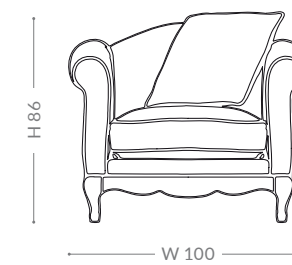

1 cuscino incluso
1 pillow included
1 подушка в комплекте
含 1 个抱枕

IPAZIA

ARMCHAIR

Struttura in legno massello; basamento in legno di faggio. Cuscini di seduta e schienale in poliuretano a quote differenziate. Parte esterna e poggiatesta ricamati.

Solid wood frame; beechwood base. Multiple densities polyurethane foam seating and backrest. Quilted outer body and headrest.

Каркас из массива дерева, основа из бука. Сиденье и спинка наполнены пенополиуретаном разной плотности. Стеганный внешняя часть и подголовник.

实木框架；山毛榉底座。座位和靠背填充多重密度聚氨酯泡沫。绗缝外部和头枕。



As picture: Ipaž a armchair
In price list: Prestige/Brilliant

Poltrona/Armchair/Кресло/扶手沙发椅
BZ 188-06 BOUCLÉ TEAL
BZ 901-632 LEATHER LIGHT BROWN

Lucidatura/Finishing/Отделка/饰面
55. COFFEE

Parti in metallo/Metal parts/Металлическая фурнитура/金属部件
TITANIUM

IPAZIA

ARMCHAIR

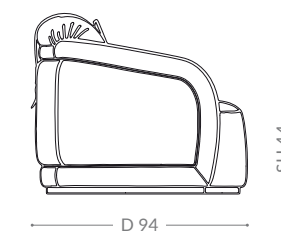
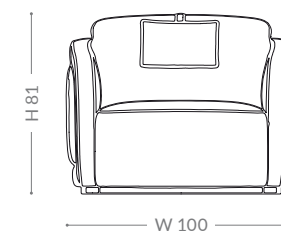

ARMCHAIRS

As picture: Ipaž a armchair
In price list: Prime

Poltrona/Armchair/Кресло/扶手沙发椅
BZ 206-11 BOUCLÉ SANDSTONE
BZ 906-2023 LEATHER CARAMEL

Lucidatura/Finishing/Отделка/饰面
100. GREY MATT

Parti in metallo/Metal parts/Метал-
лическая фурнитура/金属部件
GOLD

KING

ARMCHAIR



Struttura in legno massello; piedini in ottone. Parte interna trapuntata a quadrati e bottoni. Cuscini di seduta in vera piuma con inserto in poliuretano.

Solid wood frame; brass feet. Quilted inner body with buttons. Seat cushions in natural feather with polyurethane insert.

Каркас из массива дерева, ножки из латуни. Стеганая внутренняя часть корпуса с пуговицами. Подушки сиденья наполнены натуральным пером и имеют полиуретановую прокладку.

实木框架；黄铜沙发脚。绗缝内侧部分（带纽扣）。坐垫填充天然羽毛和聚氨酯泡沫。



A R M C H A I R S

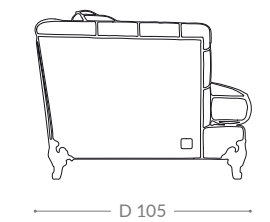
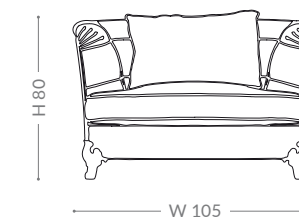

1 cuscino incluso
1 pillow included
1 подушка в комплекте
含 1 个抱枕

As picture: King armchair
In price list: Prestige

Poltrona/Armchair/Кресло/扶手沙发椅
BZ 220-06 VELVET CHOCOLATE

Cuscini/Pillows/Подушки/抱枕
BZ 221-15 UNITO CHOCOLATE

Parti in metallo/Metal parts/Металлическая фурнитура/金属部件
TITANIUM

LEGEND

ARMCHAIR



Struttura in legno massello. Gambe frontali in legno di faggio con decorazioni in ottone. Parte interna ricamata; schienale con decorazione a corsetto. Cuscini di seduta in vera piuma con inserto in poliuretano.

Solid wood frame. Beechwood front legs with brass decoration. Quilted backrest; outer body with corset decoration. Seat cushions in natural feather with polyurethane insert.

Каркас из массива дерева. Передние ножки из бука украшены элементами из латуни. Стеганая спинка, внешняя часть корпуса с корсетной отделкой. Подушки сиденья наполнены натуральным пером и имеют полиуретановую прокладку.

实木框架。山毛榉沙发脚（前脚）采用黄铜装饰。绗缝靠背；外侧部分采用交叉系绳装饰。坐垫填充天然羽毛和聚氨酯泡沫。

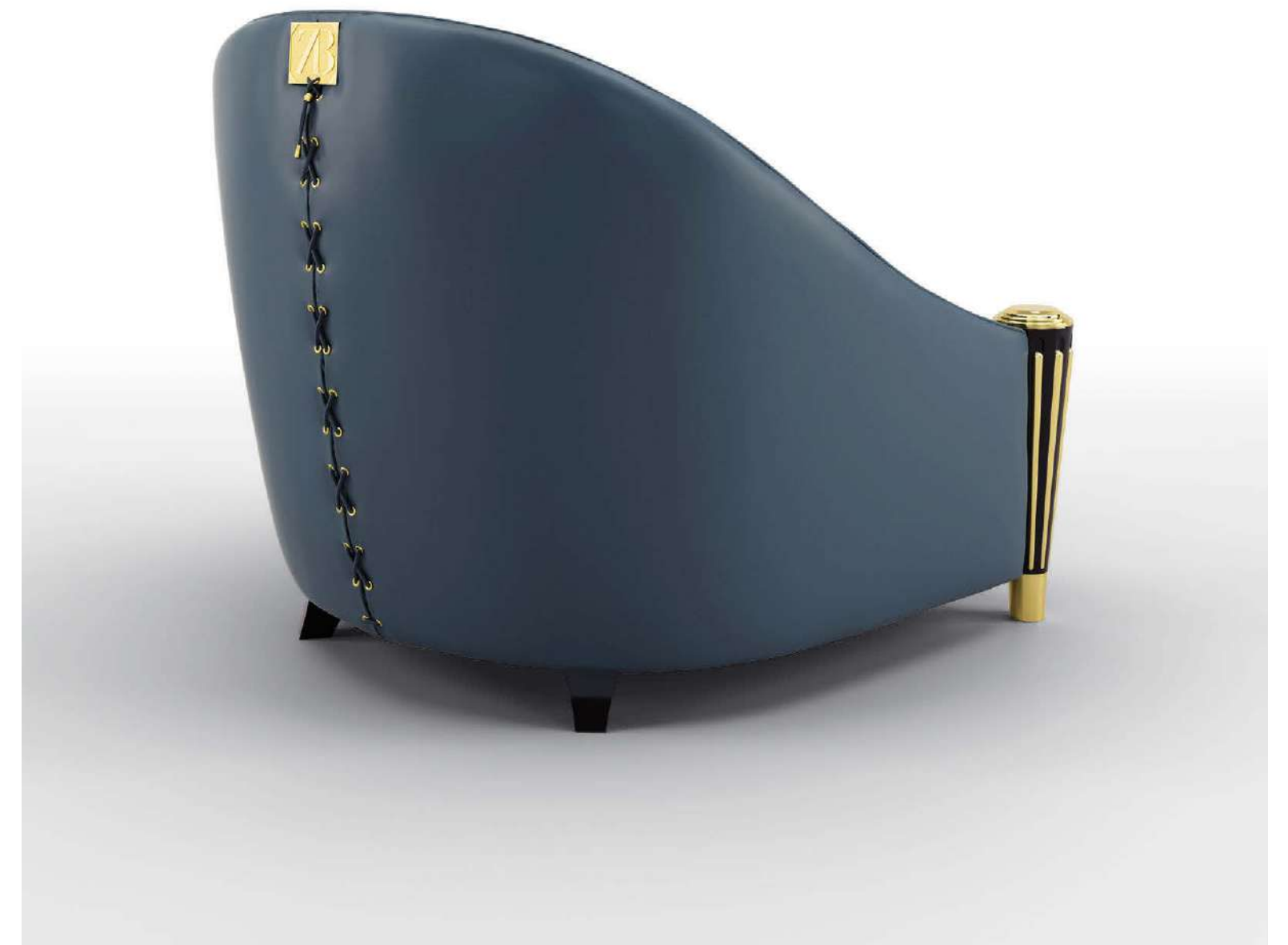

As picture: Legend armchair
In price list: Supreme/Brilliant

Poltrona/Armchair/Кресло/扶手沙发椅
BZ 901-501 LEATHER BLUE PRUSSIA
BZ 902 NABUK BLUE

Lucidatura/Finishing/Отделка/饰面
57. CHOCOLATE

Parti in metallo/Metal parts/Металлическая фурнитура/金属部件
GOLD

LEGEND

ARMCHAIR



ARMCHAIRS

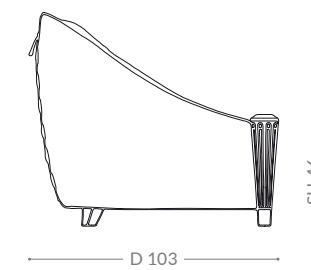
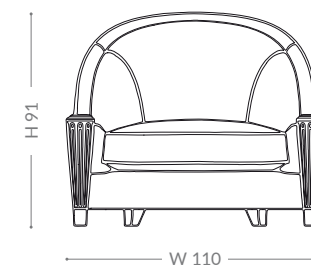

As picture: Legend armchair
In price list: Ambition/Brilliant

Poltrona/Armchair/Кресло/扶手沙发椅
BZ 901-632 LEATHER LIGHT BROWN

Lucidatura/Finishing/Отделка/饰面
55. COFFEE

Parti in metallo/Metal parts/Металлическая фурнитура/金属部件
TITANIUM

LOPEZ

ARMCHAIR



Struttura in legno massello con piedini in legno intagliato a mano; finitura con borchie. Cuscino di seduta in vera piuma.

Solid wood frame; hand-carved wooden feet. Finished with nails. Seat cushions in natural feather.

Каркас из массива дерева, деревянные ножки ручной работы. Отделка из декоративных гвоздей. Подушки сиденья наполнены натуральным пером.

实木框架；手工雕刻木制沙发脚。镶钉装饰。座垫填充天然羽毛。

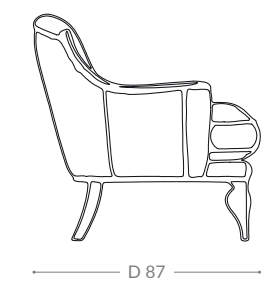
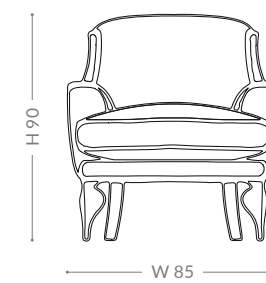

MARYLOU

ARMCHAIR

Struttura in legno massello con piedini in noce canaletto; parte esterna in capitonné. Cuscino di seduta in poliuretano a quote differenziate.

Solid wood frame; canaletto walnut wooden feet. Capitonné outer body. Multiple densities polyurethane foam seating.

Каркас из массива дерева, деревянные ножки из ореха каналетто. Внешняя часть корпуса с обивкой в виде каретной стяжки. Сиденье наполнено пенополиуретаном разной плотности.

实木框架；卡纳莱托胡桃木沙发脚。外侧部分采用分块铆钉装饰。座位填充多重密度聚氨酯泡沫。



As picture: Marylou armchair
In price list: Ambition

Poltrona/Armchair/Кресло/扶手沙发椅
BZ 905-5049 LEATHER DARK BLUE

Lucidatura/Finishing/Отделка/饰面
70. CANALETTO WALNUT MATT

MARYLOU

ARMCHAIR



ARMCHAIRS

As picture: Marylou armchair
In price list: Exclusive

Poltrona/Armchair/Кресло/扶手沙发椅
BZ 906-2030 LEATHER BURGUNDY
BZ 203-008 BOUCLÉ PLUM

Lucidatura/Finishing/Отделка/饰面
70. CANALETTO WALNUT MATT

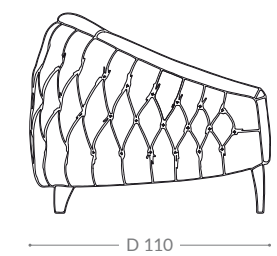
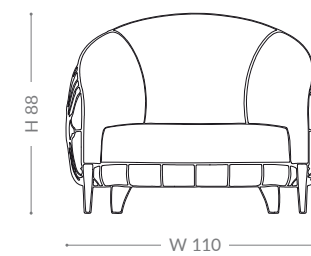

PANDORA

ARMCHAIR



Struttura in legno massello e basamento in metallo martellato. Schienale e parte esterna ricamati. Seduta e schiena in poliuretano a quote differenziate.

Solid wood frame; hammered metal base. Quilted backrest and outer body. Multiple densities polyurethane foam seating and backrest.

Каркас из массива дерева, чеканная металлическая основа. Стеганные спинка и внешняя часть корпуса. Сиденье и спинка наполнены пенополиуретаном разной плотности.

实木框架；锻造金属底座。绗缝靠背和外侧部分。座位和靠背填充多重密度聚氨酯泡沫。



As picture: Pandora armchair
In price list: Ambition

Poltrona/Armchair/Кресло/扶手沙发椅
BZ 905-5047 LEATHER DARK GREEN

Parti in metallo/Metal parts/Металлическая фурнитура/金属部件
HAMMERED TITANIUM

PANDORA

ARMCHAIR



ARMCHAIRS

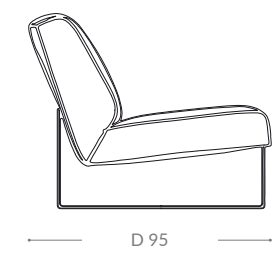
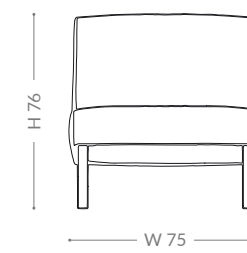

As picture: Pandora armchair
In price list: Ambition

Poltrona/Armchair/Кресло/扶手沙发椅
BZ 906-2023 LEATHER CARAMEL

Parti in metallo/Metal parts/Металлическая фурнитура/金属部件
HAMMERED GOLD

WALLY

ARMCHAIR



Struttura in legno massello sagomato. Cuscino seduta in poliuretano a quote differenziate.

Solid shaped wooden frame. Multiple densities polyurethane foam seating.

Резной каркас из массива дерева. Сиденье наполнено пенополиуретаном разной плотности.

实木型材框架。座位填充多重密度聚氨酯泡沫。

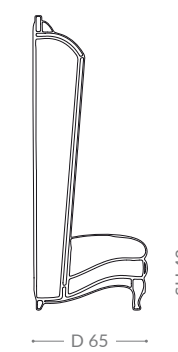
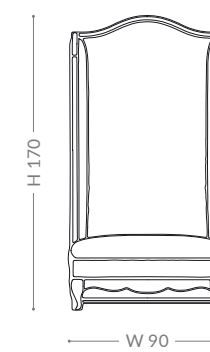

As picture: Wally armchair
In price list: Prime/Brilliant

Poltrona/Armchair/Кресло/扶手沙发椅
BZ 187-153 VELVET LOBSTER

Lucidatura/Finishing/Отделка/饰面
57. CHOCOLATE

COLETTE

DORMEUSE



Struttura in legno massello; basamento in metallo satinato. Schienale con lavorazione capitonné. Cuscino seduta in poliuretano a quote differenziate.

Solid wood frame; satin metal base. Capitonné backrest. Multiple densities polyurethane foam seating.

Каркас из массива дерева, металлическая основа. Спинка с обивкой в виде каретной стяжки. Сиденье наполнено пенополиуретаном разной плотности.

实木框架；金属底座。靠背采用分块铆钉装饰。座位填充多重密度聚氨酯泡沫。

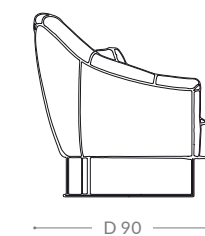
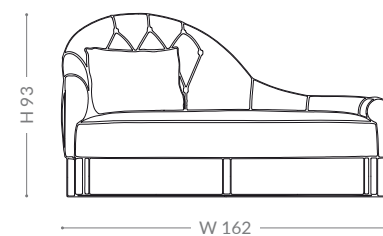
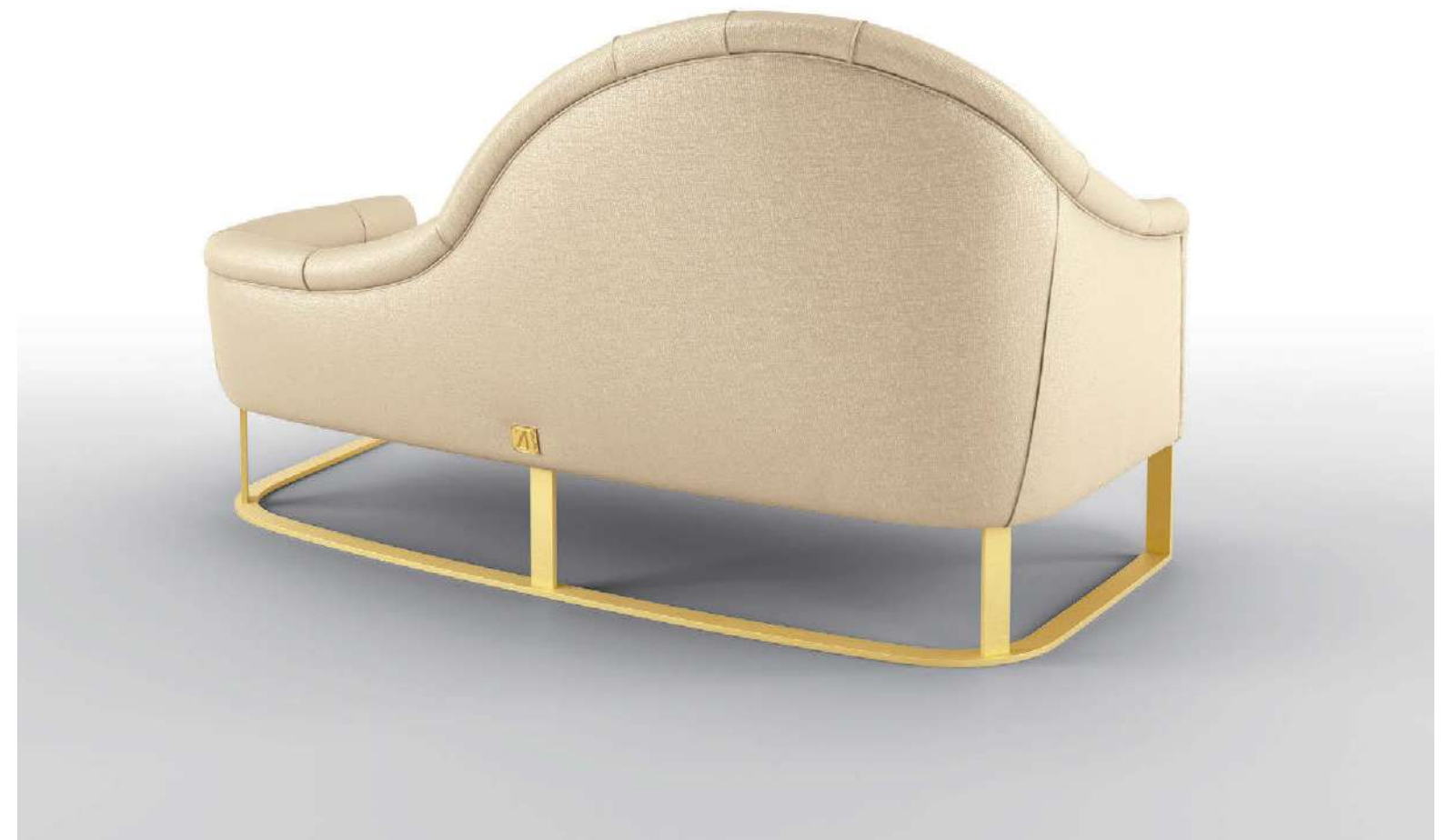

1 cuscino incluso
1 pillow included
1 подушка в комплекте
含 1 个抱枕

DORMEUSE

As picture: Colette dormeuse
In price list: Prestige

Dormeuse/Dormeuse/Кухетка/
沙发躺椅
BZ 126-50 UNITO SAND/PEARL

Cuscini/Pillows/Подушки/抱枕
BZ 187-127 VELVET SAND

Parti in metallo/Metal parts/Металлическая фурнитура/金属部件
SATIN GOLD

GERRIT

DORMEUSE

Struttura in legno massello; basamento in metallo martellato. Seduta e poggiatesta ricamati. Imbottitura in poliuretano a quote differenziate.

Solid wood frame, hammered metal base. Quilted seating and headrest. Multiple densities polyurethane foam padding.

Каркас из массива дерева, чеканная металлическая основа. Стеганные сиденье и подголовник. Набивка из пенополиуретана разной плотности.

实木框架，锻造金属底座。绗缝座位和抱枕。填充多重密度聚氨酯泡沫。



DORMEUSE

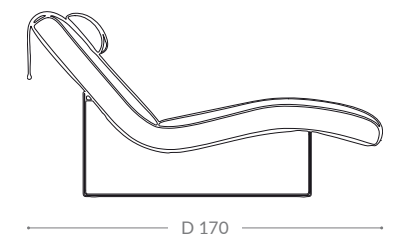
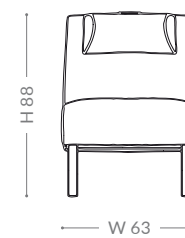

As picture: Gerrit dormeuse
In price list: Ambition

Dormeuse/Dormeuse/Кушетка/
沙发躺椅
BZ 906-2007 LEATHER MOKA

Parti in metallo/Metal parts/Металлическая фурнитура/金属部件
HAMMERED GOLD

GORDON

DORMEUSE

Struttura in legno massello; basamento in legno di faggio. Parte interna trapuntata a righe verticali. Cuscino di seduta in vera piuma con inserto in poliuretano.

Solid wood frame; beechwood base. Vertically decorated quilted inner body. Seat cushion in natural feather with polyurethane insert.

Каркас из массива дерева, основа из бука. Стеганая внутренняя часть корпуса имеет вертикальную отделку. Подушка сиденья наполнена натуральным пером и имеет полиуретановую прокладку.

实木框架；山毛榉底座。内侧部分采用竖直接装饰缝。坐垫填充天然羽毛和聚氨酯泡沫。



DORMEUSE

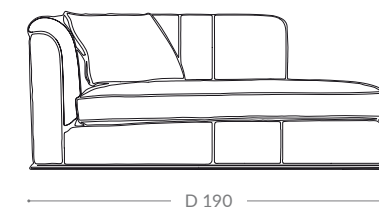
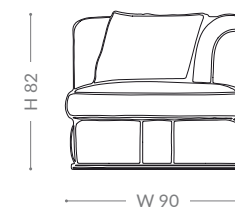

1 cuscino incluso
1 pillow included
1 подушка в комплекте
含 1 个抱枕

As picture: Gordon dormeuse
In price list: Prime

Dormeuse/Dormeuse/Кухетка/
沙发躺椅
BZ 200-502 VELVET DARK GREEN

Cuscini/Pillows/Подушки/抱枕
BZ 184-903 PALMA GREEN

Lucidatura/Finishing/Отделка/饰面
85. CHOCOLATE MATT

LEGEND

DORMEUSE

Struttura in legno massello. Gamba laterale in legno di faggio con decorazioni in ottone. Parte interna ricamata; schiena-
le con decorazione a corsetto. Cuscino di seduta in vera piuma con inserto in poliuretano.

Solid wood frame. Beechwood side leg with brass decoration. Quilted inner body; outer body with corset decoration. Seat cushion in natural feather with polyurethane insert.

Каркас из массива дерева. Боковая часть ножки из бука украшена элементами из латуни. Стеганая внутренняя часть корпуса, внешняя часть корпуса имеет корсетную отделку. Подушка сиденья наполнена натуральным пером и имеет полиуретановую прокладку.

实木框架。山毛榉侧位沙发脚带有黄铜装饰。绗缝内侧部分；外侧部分采用交叉系绳装饰。坐垫填充天然羽毛和聚氨酯泡沫。

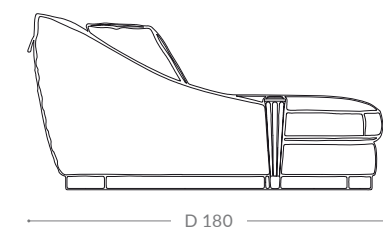
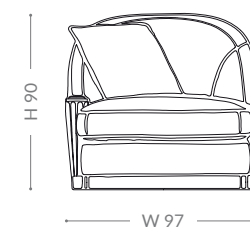

1 cuscino incluso
1 pillow included
1 подушка в комплекте
含 1 个抱枕

DORMEUSE

As picture: Legend dormeuse
In price list: Ambition/Brilliant

Dormeuse/Dormeuse/Кухетка/
沙发躺椅
BZ 905-5141 LEATHER DARK GREY

Cuscini/Pillows/Подушки/抱枕
BZ 191-003 JACQUARD GREY
Lucidatura/Finishing/Отделка/饰面
58. BLACK

Parti in metallo/Metal parts/Метал-
лическая фурнитура/金属部件
TITANIUM

ADAM

POUF



P
O
U
F
S

As picture: Adam pouf
In price list: Ambition
Pouf/Pouf/Пуф/沙发脚凳
BZ 906-2023 LEATHER CAMEL

As picture: Adam pouf
In price list: Ambition
Pouf/Pouf/Пуф/沙发脚凳
BZ 905-5047 LEATHER DARK GREEN

As picture: Adam pouf
In price list: Ambition
Pouf/Pouf/Пуф/沙发脚凳
BZ 906-2006 LEATHER TAUPE

Struttura in legno massello.
Imbottitura in poliuretano
a quote differenziate con
lavorazione capitonné.

Solid wood frame. Multiple
densities polyurethane foam
padding with capitonné
decoration.

Каркас из массива дерева.
Набивка из пенополиуретана
разной плотности, отделка в
виде каретной стяжки.

实木框架。填充多重密度聚氨
酯泡沫，采用分块铆钉装饰。

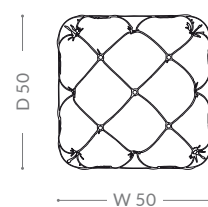
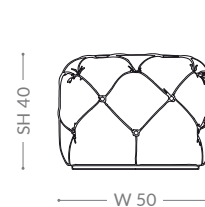

BELLE

POUF



P
O
U
F
S

As picture: Belle pouf
In price list: Prime
Pouf/Pouf/Пуф/沙发脚凳
BZ 200-502 VELVET DARK GREEN

Parti in metallo/Metal parts/
Металлическая фурнитура/
金属部件
SATIN TITANIUM

As picture: Belle pouf
In price list: Prestige
Pouf/Pouf/Пуф/沙发脚凳
BZ 211-1120 MELANGE VELVET BURGUNDY

Parti in metallo/Metal parts/
Металлическая фурнитура/
金属部件
SATIN GOLD

Struttura in legno massello;
basamento in metallo.
Imbottitura in poliuretano a
quote differenziate.

Solid wood frame; metal
base. Multiple densities
polyurethane foam padding.

Каркас из массива дерева,
металлическая основа.
Набивка из пенополиуретана
разной плотности.

实木框架；金属底座。填充多
重密度聚氨酯泡沫。

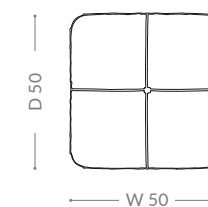
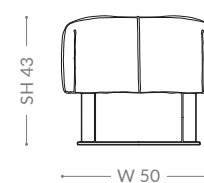

FLY

POUF

P O U F S



As picture: Fly pouf
In price list: Prestige/Brilliant



Pouf/Pouf/Пугф/沙发脚凳
BZ 126-51 UNITO GREY/PEARL

Lucidatura/Finishing/Отделка/饰面
54. GREY

Struttura in legno massello; basamento in legno sagomato. Cuscino di seduta in vera piuma con inserto in poliuretano.

Solid wood frame; shaped wooden base. Cushion seating in natural feather with polyurethane insert.

Каркас из массива дерева, фигурная деревянная основа. Подушка сиденья наполнена натуральным пером и имеет полиуретановую прокладку.

实木框架；木制型材底座。坐垫填充天然羽毛和聚氨酯泡沫。

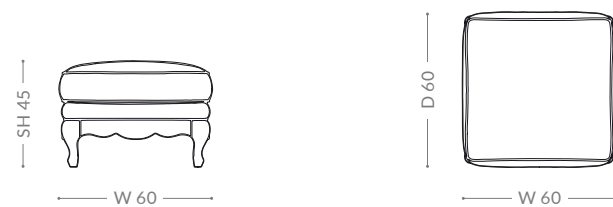

FLY CAPITONNÉ

POUF



As picture: Fly Capitonné pouf
In price list: Prime/Brilliant



Pouf/Pouf/Пугф/沙发脚凳
BZ 200-202 VELVET BURGUNDY

Lucidatura/Finishing/Отделка/饰面
57. CHOCOLATE

P O U F S

Struttura in legno massello; basamento in legno di faggio sagomato. Seduta in poliuretano con lavorazione capitonné.

Solid wood frame; shaped beechwood base. Polyurethane foam seating with capitonné decoration.

Каркас из массива дерева, фигурная основа из бука. Сиденье из пенополиуретана украшено каретной стяжкой.

实木框架；山毛榉型材底座。聚氨酯泡沫填充座位，采用分块铆钉装饰。



KIMBERLY

POUF



As picture: Kimberly pouf
In price list: Ambition

Pouf/Pouf/Пуф/沙发脚凳
BZ 906-2030 LEATHER BURGUNDY



Lucidatura/Finishing/Отделка/饰面
91. BURGUNDY MATT

Parti in metallo/Metal parts/Металлическая фурнитура/金属部件
GOLD

Struttura in legno massello.
Parte esterna ricamata.
Imbottitura in poliuretano a quote differenziate.

Solid wood frame. Quilted
outer body. Multiple densities
polyurethane foam padding.

Каркас из массива дерева.
Стеганая внешняя часть
корпуса. Набивка из
пенополиуретана разной
плотности.

实木框架。外侧部分绗缝。填充多重密度聚氨酯泡沫。

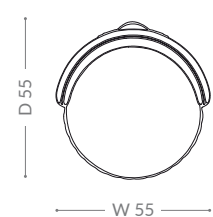
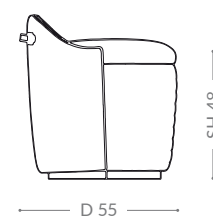
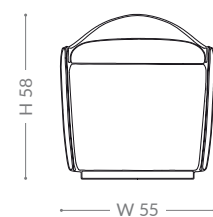

MOON WALT

POUF



As picture: Moon Walt pouf
In price list: Ambition/Brilliant

Pouf/Pouf/Пуф/沙发脚凳
BZ 901-702 LEATHER DOVE GREY



Lucidatura/Finishing/Отделка/饰面
54. GREY

Struttura in legno massello;
basamento in legno decorato.
Parte esterna trapuntata.
Imbottitura in poliuretano
a quote differenziate.

Solid wood frame; decorated
wooden base. Quilted outer
body. Multiple densities
polyurethane foam padding.

Каркас из массива дерева,
деревянная основа с
отделкой. Стеганая внешняя
часть корпуса. Набивка из
пенополиуретана разной
плотности.

实木框架；带装饰木制底座。
外侧部分绗缝。填充多重密度
聚氨酯泡沫。

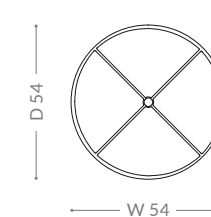
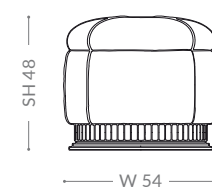

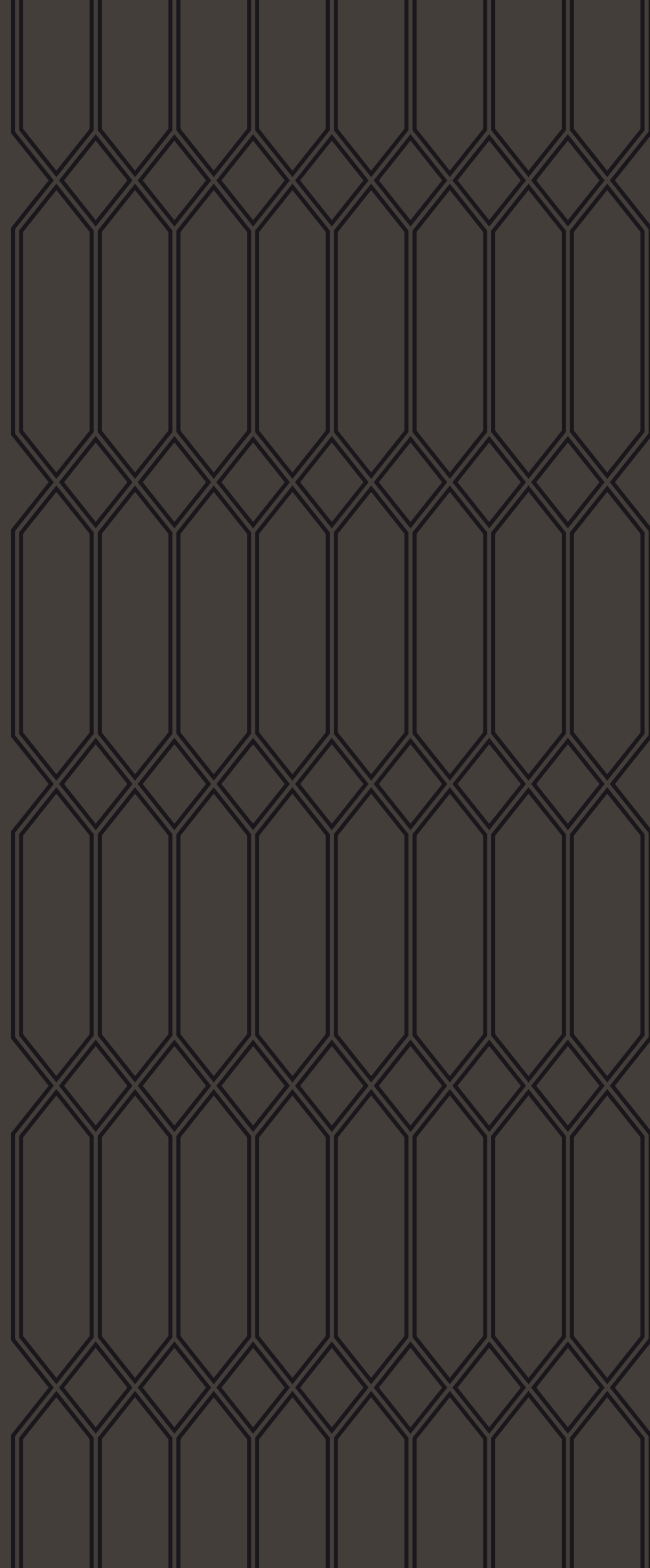

ZB

SOFA TABLES



ALCESTE

SIDE TABLE



SOFA TABLES

As picture: Alceste side table
In price list: Brilliant



Lucidatura/Finishing/Отделка/饰面
98. WENGÉ



Parti in metallo/Metal parts/Металлическая фурнитура/金属部件
SATIN GOLD

Struttura in metallo, finitura disponibile oro satin. Piano disponibile in noce canaletto.

Metal frame; available in satin gold finishing. Top available in canaletto walnut wood.

Металлический каркас, глянцевая золотистая отделка. Деревянная столешница из ореха каналетто.

金属框架；缎面金饰面。选用卡纳莱托胡桃木桌面。

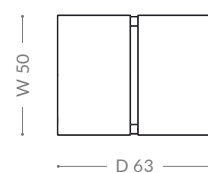
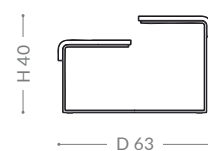
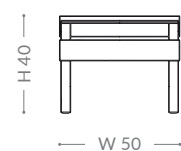

CLUB

CENTRAL TABLE



As picture: Club central table
In price list: Brilliant

Lucidatura/Finishing/Отделка/饰面
54. GREY



Decorazione/Decoration/Декоративный элемент/装饰
BZ 901-702 LEATHER DOVE GREY

Struttura in legno massello; piedini in legno intagliati a mano. Parte centrale in legno con inserto in multistrati decorato con traforo.

Solid wood frame; hand-carved wooden feet. Fretwork plywood decoration.

Каркас из массива дерева, деревянные ножки ручной работы. Резное украшение из фанеры.

实木框架；手工雕刻木制桌脚。胶合板镂空装饰。

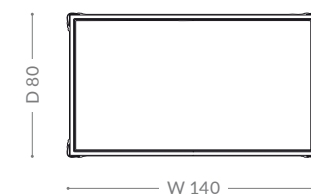
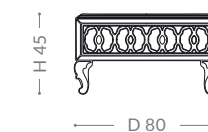

SOFA TABLES

CLUB

SIDE TABLE

S O F A T A B L E S



As picture: Club side table
In price list: Brilliant



Lucidatura/Finishing/Отделка/饰面
57. CHOCOLATE

Decorazione/Decoration/
Декоративный элемент/装饰
BZ 901-215 LEATHER DARK BROWN

Struttura in legno massello; piedini in legno intagliati a mano. Parte centrale in legno con inserto in multistrati decorato con traforo.

Solid wood frame; hand-carved wooden feet. Fretwork plywood decoration.

Каркас из массива дерева, деревянные ножки ручной работы. Резное украшение из фанеры.

实木框架；手工雕刻木制桌脚。胶合板镂空装饰。

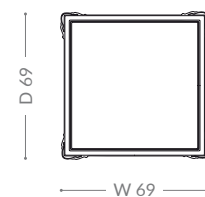
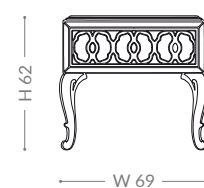

DEA

SIDE TABLE



As picture: Dea side table
In price list: Brilliant

Lucidatura/Finishing/Отделка/饰面
71. WALNUT BRIAR ROOT



Parti in metallo/Metal parts/Металлическая фурнитура/金属部件
SATIN GOLD

Struttura in metallo, finitura disponibile oro satin. Piano disponibile in piuma di noce.

Metal frame; available in satin gold finishing. Top available in walnut briar root.

Металлический каркас, глянцевая золотистая отделка. Доступный материал столешницы: орех бриар.

金属框架；缎面金饰面。桌面选用胡桃根。

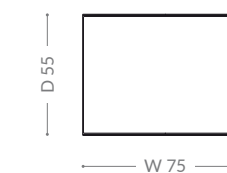
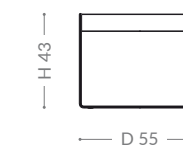
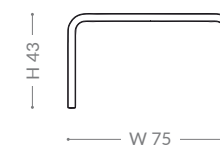

S O F A T A B L E S

DEA

TWIN SET

SOFA TABLES



As picture: Dea twin set
(1 table large + 1 table small)
In price list: Brilliant



Parti in metallo/Metal parts/Металлическая фурнитура/金属部件
SATIN GOLD

Piano/Top/Столешница/桌面
BZ 906-2023 LEATHER CARAMEL
71. WALNUT BRIAR ROOT

Struttura in metallo, finitura disponibile oro satin. Piano disponibile in piuma di noce per tavolino grande; in pelle per tavolino piccolo.

Metal frame; available in satin gold finishing. Top available: walnut briar root for large table, leather for small table.

Металлический каркас, глянцевая золотистая отделка. Столешница из ореха бриар для большого стола, из кожи для маленького стола.

金属框架；缎面金饰面。桌面选用：大桌胡桃根，小桌皮革。

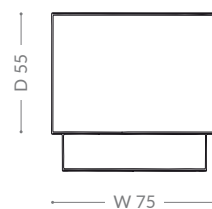
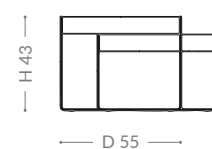
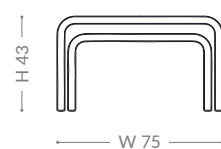

ESEDRA

SIDE TABLE



As picture: Esedra side table
In price list: Brilliant

Lucidatura/Finishing/Отделка/饰面
70. CANALETTO WALNUT MATT



Piano/Top/Столешница/桌面
54. GREY

SOFA TABLES

Struttura in essenza di noce canaletto. Piano disponibile in legno laccato, marmo o legno rivestito in pelle.

Solid wood canaletto walnut frame. Top available in lacquered wood, marble or leather covered wood.

Каркас из массива ореха каналетто. Доступна столешница из лакированной древесины, мрамора или древесины с кожаной обивкой.

卡纳莱托胡桃木实木框架。桌面可选用漆木、大理石或皮革木材。

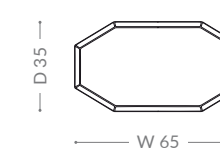
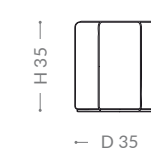
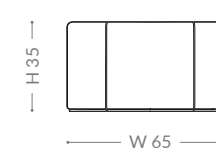

ESEDRA

CENTRAL TABLE SET



SOFA TABLES

As picture: Esedra central table set
In price list: Ambition+Brilliant+Precious stone



Lucidatura/Finishing/Отделка/饰面
70. CANALETTO WALNUT MATT

Piano/Top/Столешница/桌面
54. GREY
BRONZE AMANI
BZ 906-2006 LEATHER TAUPE



Struttura in essenza di noce canaletto. Piano disponibile in legno laccato, marmo o legno rivestito in pelle.

Solid wood canaletto walnut frame. Top available in lacquered wood, marble or leather covered wood.

Каркас из массива ореха каналетто. Доступна столешница из лакированной древесины, мрамора или древесины с кожаной обивкой.

卡纳莱托胡桃木实木框架。桌面可选用漆木、大理石或皮革木材。

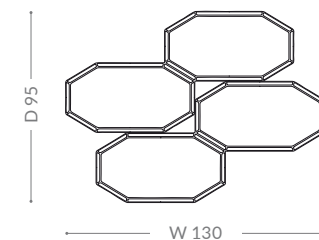
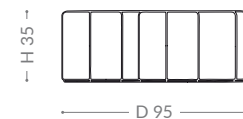
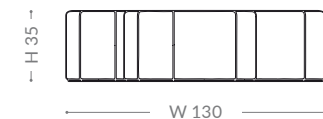

EXPERIA

CENTRAL TABLE



As picture: Experia central table
In price list: Brilliant

Lucidatura/Finishing/Отделка/饰面
69. CANALETTO WALNUT
57. CHOCOLATE

Marmo/Marble/Мрамор/大理石
ROSSO LEPANTO

Struttura in legno massello. Piedini in noce canaletto; piano in marmo.

Solid wood frame. Canaletto walnut wooden feet; marble top.

Каркас из массива дерева. Деревянные ножки из ореха каналетто, столешница из мрамора.

实木框架。胡桃木桌脚；大理石桌面。

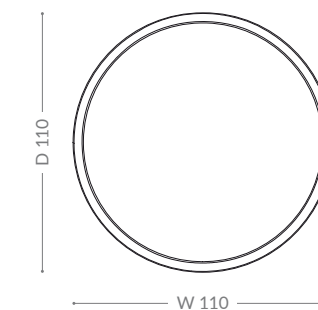
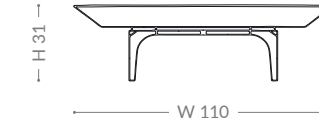

SOFA TABLES

FLY

CENTRAL TABLE



SOFA TABLES



As picture: Fly central table
In price list: Brilliant

Lucidatura/Finishing/Отделка/饰面
54. GREY
63. WHITENED CANALETTO WALNUT

Struttura in legno massello sagomato. Piano disponibile in ebano makassar o noce canaletto.

Solid shaped wood frame. Top available in makassar ebony or canaletto walnut veneer.

Резной каркас из массива дерева. Доступна столешница из шпона макассарского эбена или ореха каналетто.

实木型材框架。桌面可选望加锡乌木或卡纳莱托胡桃木饰面板。

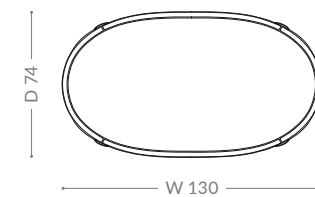
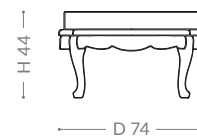
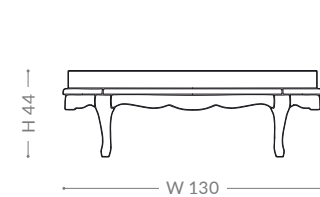

FLY

SIDE TABLE



As picture: Fly side table
In price list: Brilliant

Lucidatura/Finishing/Отделка/饰面
57. CHOCOLATE
65. MAKASSAR

Struttura in legno massello sagomato. Piano disponibile in ebano makassar o noce canaletto.

Solid shaped wood frame. Top available in makassar ebony or canaletto walnut veneer.

Резной каркас из массива дерева. Доступна столешница из шпона макассарского эбена или ореха каналетто.

实木型材框架。桌面可选望加锡乌木或卡纳莱托胡桃木饰面板。

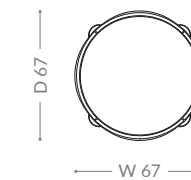
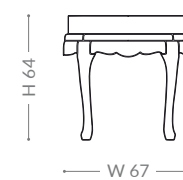

SOFA TABLES

GREY

TABLE SET

S O F A T A B L E S



As picture: Grey table set
(Grey pouf + Dea side table)
In price list: Brilliant

Pouf/Pouf/Пуф/沙发脚凳
BZ 906-2005 LEATHER OASI



Lucidatura/Finishing/Отделка/饰面
71. WALNUT BRIAR ROOT

Parti in metallo/Metal parts/Металлическая фурнитура/金属部件
SATIN GOLD

Panchetta con struttura in legno massello; realizzata in pelle ricamata. Imbottitura in poliuretano a quote differenziate. Tavolino con struttura in metallo, finitura disponibile oro satin. Piano disponibile in piuma di noce.

Small bench; solid wooden structure. Quilted leather. Multiple densities polyurethane foam padding. Metal frame small table, available in satin gold finishing. Top available in walnut briar root.

Небольшая скамья, конструкция из массива дерева. Стеганая кожа. Набивка из пенополиуретана разной плотности. Маленький столик с металлическим каркасом, золотистая глянцевая отделка. Доступный материал столешницы: орех бриар.

小凳; 实木结构。绗缝皮革。多重密度聚氨酯泡沫填充。金属框架小桌，缎面金色饰面。桌面为胡桃根质地。

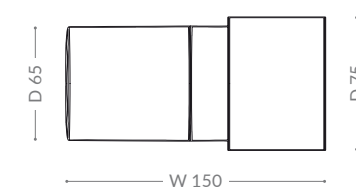
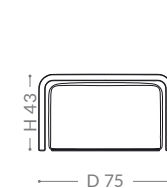
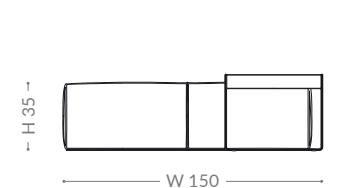

HECTOR

SIDE TABLE



As picture: Hector side table square 78
In price list: Prime

Lucidatura/Finishing/Отделка/饰面
85. CHOCOLATE MATT
70. CANALETTO WALNUT MATT

Base tavolino in legno massello. Piano in multistrati di legno, disponibile in noce canaletto o ebano makassar.

Solid wood base. Plywood top, available in makassar ebony or canaletto veneer.

Основа из массива дерева. Столешница из фанеры, доступна из шпона макассарского эбена и ореха каналетто.

实木底座。胶合板桌面，可选望加锡乌木或卡纳莱托胡桃木饰面板。

HECTOR side table square 78

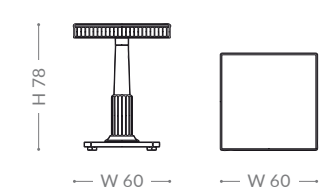

HECTOR side table round 78

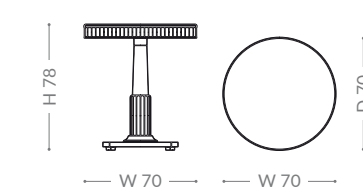

HECTOR side table square 65

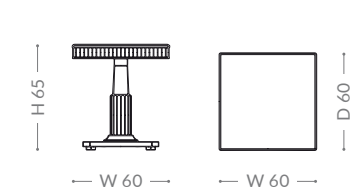

HECTOR side table round 65

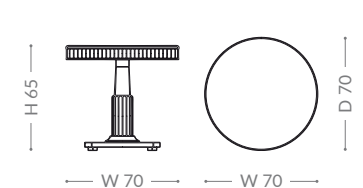

S O F A T A B L E S

MUMFORD

CENTRAL TABLE



SOFA TABLES

As picture: Mumford central table
In price list: Brilliant

Lucidatura/Finishing/Отделка/饰面
57. CHOCOLATE

Parti in metallo/Metal parts/Металлическая фурнитура/金属部件
TITANIUM

Decorazione/Decoration/Декоративный элемент/装饰
BZ 904-4632 LEATHER SAND

Struttura in metallo. Gambe laterali in legno di faggio con decorazioni in ottone. Base rivestita in pelle ricamata; piano in vetro.

Metal frame. Beechwood legs with brass decoration. Quilted leather base; glass top.

Металлический каркас. Ножки из бука украшены элементами из латуни. Основа из стеганой кожи, стеклянная столешница.

金属框架。黄铜装饰山毛榉桌脚。绗缝皮革底座；玻璃桌面。

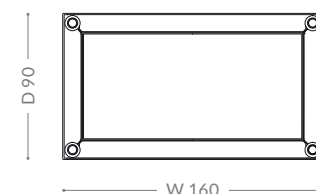
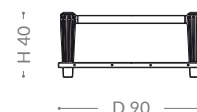
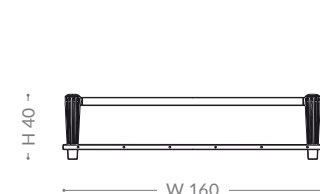

MUMFORD

SIDE TABLE

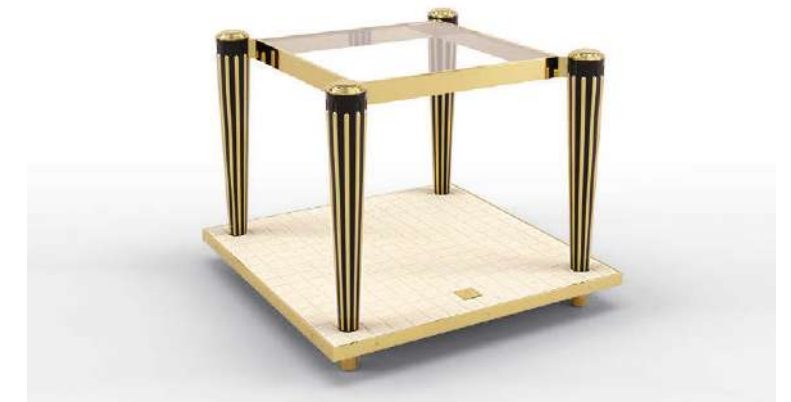

SOFA TABLES

As picture: Mumford side table
In price list: Brilliant

Lucidatura/Finishing/Отделка/饰面
57. CHOCOLATE

Parti in metallo/Metal parts/Металлическая фурнитура/金属部件
GOLD

Decorazione/Decoration/Декоративный элемент/装饰
BZ 901-332 LEATHER BUTTER

Struttura in metallo. Gambe laterali in legno di faggio con decorazioni in ottone. Base rivestita in pelle ricamata; piano in vetro.

Metal frame. Beechwood legs with brass decoration. Quilted leather base; glass top.

Металлический каркас. Ножки из бука украшены элементами из латуни. Основа из стеганой кожи, стеклянная столешница.

金属框架。黄铜装饰山毛榉桌脚。绗缝皮革底座；玻璃桌面。

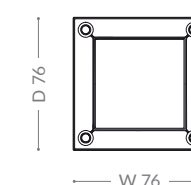
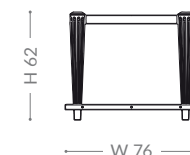

NEW LINE

RECTANGULAR CENTRAL TABLE

SOFA TABLES



As picture: New Line rectangular central table
In price list: Precious stone



Lucidatura/Finishing/Отделка/饰面
70. CANALETTO WALNUT MATT

Marmo/Marble/Мрамор/大理石
FUSION GREEN



Struttura in noce canaletto massello. Piano disponibile in essenza (noce canaletto), marmo o legno rivestito in pelle.

Solid wood canaletto walnut frame. Top available in wood veneer (canaletto walnut), marble or leather covered wood.

Каркас из массива ореха кана-летто. Доступна столешница из деревянного шпона (орех каналетто), мрамора или древе-сины с кожаной обивкой.

卡纳莱托胡桃木实木框架。桌面可选用木制饰面板（卡纳莱托胡桃木）、大理石或皮革木材。

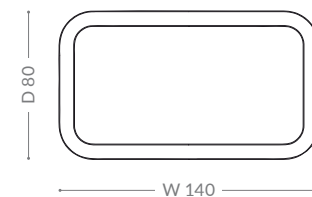
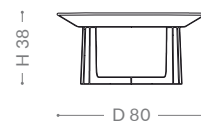
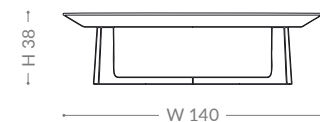

NEW LINE

SQUARE CENTRAL TABLE

SOFA TABLES



As picture: New Line square central table
In price list: Ambition

Lucidatura/Finishing/Отделка/饰面
93. WENGÉ MATT

Materiale/Material/Материал/
材料
BZ 906-2023 LEATHER CARAMEL

Struttura in noce canaletto massello. Piano disponibile in essenza (noce canaletto), marmo o legno rivestito in pelle.

Solid wood canaletto walnut frame. Top available in wood veneer (canaletto walnut), marble or leather covered wood.

Каркас из массива ореха кана-летто. Доступна столешница из деревянного шпона (орех каналетто), мрамора или древе-сины с кожаной обивкой.

卡纳莱托胡桃木实木框架。桌面可选用木制饰面板（卡纳莱托胡桃木）、大理石或皮革木材。

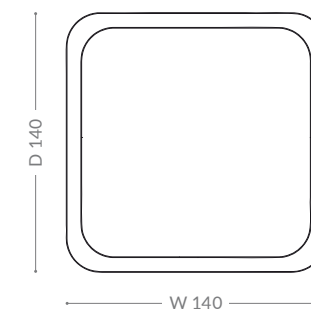
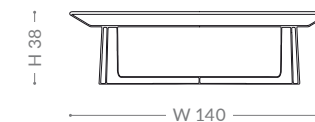

NEW LINE

SIDE TABLE

S O F A T A B L E S



As picture: New Line side table
In price list: Ambition/Brilliant



Lucidatura/Finishing/Отделка/饰面
69. CANALETTO WALNUT



Materiale/Material/Материал/
材料
BZ 906-2030 LEATHER BURGUNDY

Struttura in noce canaletto massello. Piano disponibile in essenza (noce canaletto), marmo o legno rivestito in pelle.

Solid wood canaletto walnut frame. Top available in wood veneer (canaletto walnut), marble or leather covered wood.

Каркас из массива ореха каналетто. Доступна столешница из деревянного шпона (орех каналетто), мрамора или древесины с кожаной обивкой.

卡纳莱托胡桃木实木框架。桌面可选用木制饰面板（卡纳莱托胡桃木）、大理石或皮革木材。

NEW LINE

SIDE TABLE



As picture: New Line side table
In price list: Precious stone



Lucidatura/Finishing/Отделка/饰面
70. CANALETTO WALNUT MATT



Marmo/Marble/Мрамор/大理石
MACAUBAS GIOTTO

S O F A T A B L E S

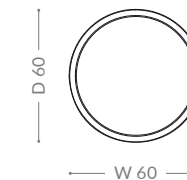
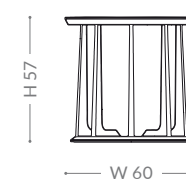

OLIVER

CENTRAL TABLE



SOFA TABLES

As picture: Oliver central table
In price list: Brilliant



Lucidatura/Finishing/Отделка/饰面
65. MAKASSAR

Parti in metallo/Metal parts/Металлическая фурнитура/金属部件
61. DIAMOND GOLD

Struttura in acciaio; piano disponibile in noce canaletto o ebano makassar.

Steel frame. Top available in canaletto walnut or makassar ebony veneer.

Стальной каркас. Доступна столешница из шпона ореха каналетто или макассарского эбена.

钢制框架。桌面可选卡纳莱托胡桃木或望加锡乌木饰面板。

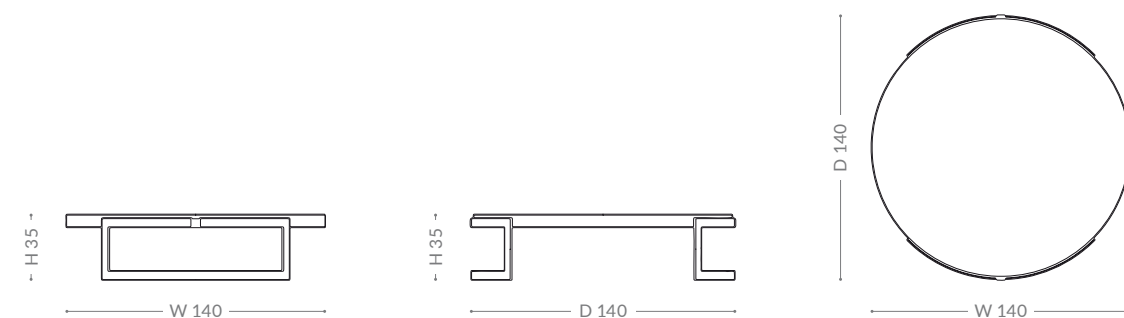

OLIVER

SIDE TABLE



As picture: Oliver side table
In price list: Brilliant



Lucidatura/Finishing/Отделка/饰面
63. WHITENED CANALETTO WALNUT

Parti in metallo/Metal parts/Металлическая фурнитура/金属部件
61. DIAMOND GOLD

Struttura in acciaio; piano disponibile in noce canaletto o ebano makassar.

Steel frame. Top available in canaletto walnut or makassar ebony veneer.

Стальной каркас. Доступна столешница из шпона ореха каналетто или макассарского эбена.

钢制框架。桌面可选卡纳莱托胡桃木或望加锡乌木饰面板。

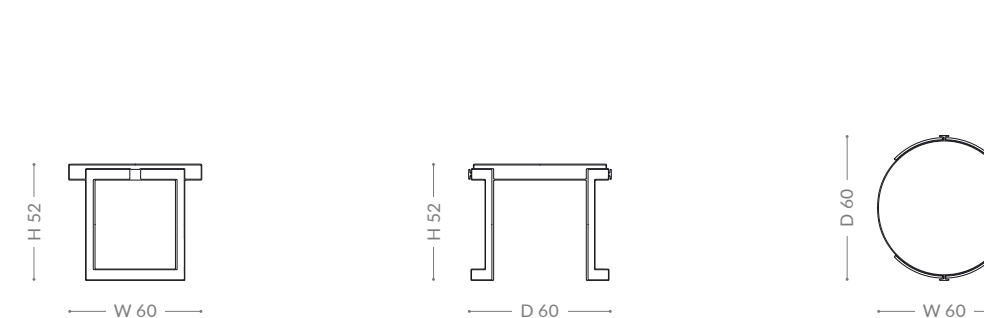

SOFA TABLES

OLIVER

COURTESY TABLE

SOFA TABLES



As picture: Oliver courtesy table
In price list: Brilliant

Struttura in acciaio; piano disponibile in noce canaletto o ebano makassar.

Steel frame. Top available in canaletto walnut or makassar ebony veneer.



Lucidatura/Finishing/Отделка/饰面
64. CANALETTO WALNUT

Стальной каркас. Доступна столешница из шпона ореха каналетто или макассарского эбена.



Parti in metallo/Metal parts/Металлическая фурнитура/金属部件
54. GREY

钢制框架。桌面可选卡纳莱托胡桃木或望加锡乌木饰面板。

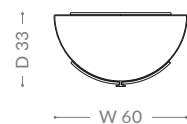
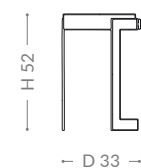
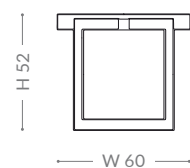

OTTO

CENTRAL TABLE



As picture: Otto central table
In price list: Brilliant

Struttura realizzata in legno massello, multistrati di legno e MDF. Piano in noce canaletto.

Lucidatura/Finishing/Отделка/饰面
57. CHOCOLATE
64. CANALETTO WALNUT

Solid wood frame, plywood and MDF. Canaletto walnut wooden top.



SOFA TABLES

Каркас из массива дерева, фанера и МДФ. Деревянная столешница из ореха каналетто.

实木框架，胶合板和密度板。卡纳莱托胡桃木桌面。

OTTO

CENTRAL TABLE

S O F A T A B L E S



As picture: Otto central table
In price list: Prime

Lucidatura/Finishing/Отделка/饰面
100. GREY MATT
73. CANALETTO WALNUT MATT

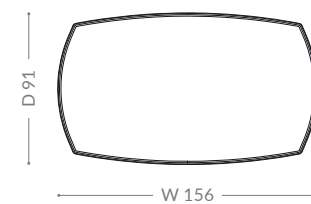
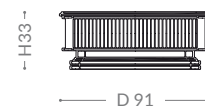
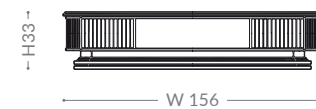

RUPERT

CENTRAL TABLE

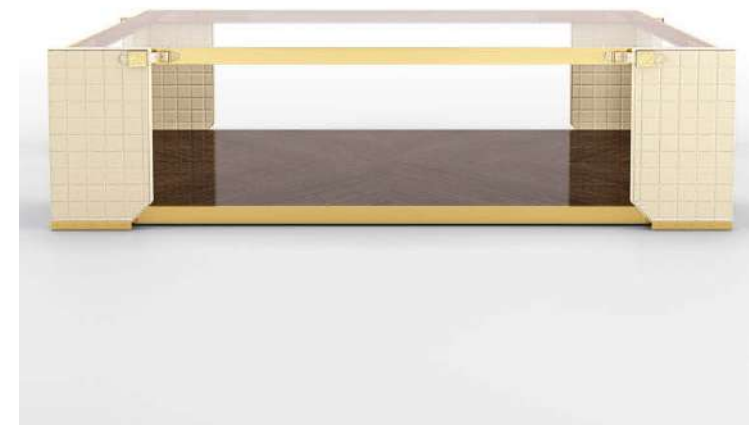

As picture: Rupert central table
In price list: Brilliant

Lucidatura/Finishing/Отделка/饰面
65. EBANO MAKASSAR

Struttura in metallo. Gambe decorate con pelle ricamata. Base disponibile in ebano makassar o eucalipto fris . Piano in vetro.

Metal frame. Quilted leather legs. Base available in makassar ebony or eucalyptus fris  veneer. Glass top.

Parti in metallo/Metal parts/Металлическая фурнитура/金属部件
GOLD

Металлический каркас. Ножки из стеганой кожи. Доступна столешница из шпона макаassarского эбен или эвкалипта. Стекланная столешница.

Decorazione/Decoration/Декоративный элемент/装饰
BZ 901-332 LEATHER BUTTER

金属框架。绗缝皮革桌脚。底座可选望加锡乌木或尤加利木饰面板。玻璃桌面。

S O F A T A B L E S

RUPERT

CENTRAL TABLE



As picture: Rupert central table
In price list: Brilliant

Lucidatura/Finishing/Отделка/饰面
68. EUCALYPTUS FRISÉ



Parti in metallo/Metal parts/Металлическая фурнитура/金属部件
TITANIUM

Decorazione/Decoration/Декоративный элемент/装饰
BZ 901-632 LEATHER LIGHT BROWN

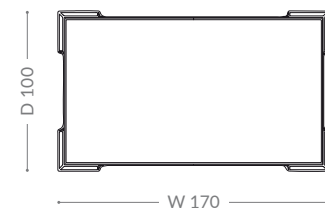
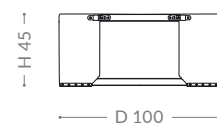
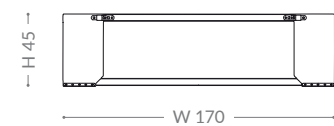

RUPERT

ROUND TABLE



As picture: Rupert round table
In price list: Brilliant

Lucidatura/Finishing/Отделка/饰面
68. EUCALYPTUS FRISÉ



Parti in metallo/Metal parts/Металлическая фурнитура/金属部件
TITANIUM

Decorazione/Decoration/Декоративный элемент/装饰
BZ 901-632 LEATHER LIGHT BROWN

Struttura in metallo. Gambe decorate con pelle ricamata. Base disponibile in ebano makassar o eucalipto frisé. Piano in vetro.

Metal frame. Quilted leather legs. Base available in makassar ebony or eucalyptus frisé veneer. Glass top.

Металлический каркас. Ножки из стеганой кожи. Доступна столешница из шпона макассарского эбена или эвкалипта. Стеклопанель столешница.

金属框架。绗缝皮革桌脚。底座可选望加锡乌木或尤加利木饰面板。玻璃桌面。

RUPERT

ROUND TABLE

SOFA TABLES



As picture: Rupert round table
In price list: Brilliant

Lucidatura/Finishing/Отделка/饰面
65. MAKASSAR



Parti in metallo/Metal parts/Металлическая фурнитура/金属部件
GOLD

Decorazione/Decoration/Декоративный элемент/装饰
BZ 901-332 LEATHER BUTTER

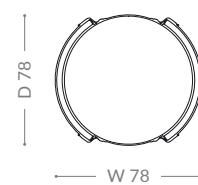
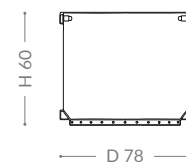
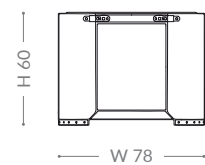

STAN

CENTRAL TABLE



As picture: Stan central table
In price list: Brilliant

Lucidatura/Finishing/Отделка/饰面
94. TAUPE

Struttura in acciaio. Base e piano in multistrati di legno. Disponibile laccato.

Steel frame. Plywood base and top. Available in lacquered finishing.

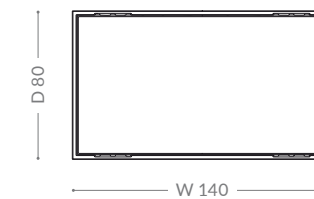
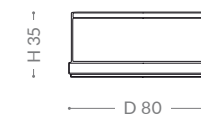
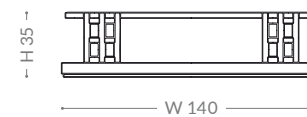

SOFA TABLES

Стальной каркас. Основа и столешница из фанеры. Лаковая отделка.

钢制框架。胶合板底座和桌面。喷漆饰面。

STAN

COURTESY TABLE

SOFA TABLES



As picture: Stan courtesy table
In price list: Brilliant

Lucidatura/Finishing/Отделка/饰面
51. SAND

Struttura in acciaio. Base e piano in multistrati di legno. Disponibile laccato.

Steel frame. Plywood base and top. Available in lacquered finishing.

Стальной каркас. Основа и столешница из фанеры. Лаковая отделка.

钢制框架。胶合板底座和桌面。喷漆饰面。

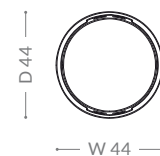
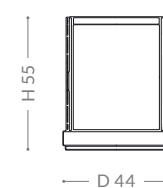
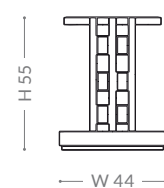

STAN

SIDE TABLE



SOFA TABLES

As picture: Stan side table
In price list: Brilliant

Lucidatura/Finishing/Отделка/饰面
96. BURGUNDY

Struttura in acciaio. Base e piano in multistrati di legno. Disponibile laccato.

Steel frame. Plywood base and top. Available in lacquered finishing.

Стальной каркас. Основа и столешница из фанеры. Лаковая отделка.

钢制框架。胶合板底座和桌面。喷漆饰面。

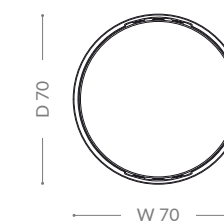
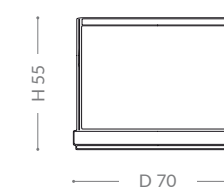
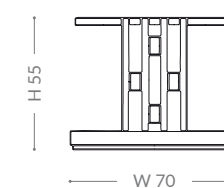

TRITON

CENTRAL TABLE



Base in metallo placcato oro; disponibile con piano in legno laccato, in essenza (ebano makassar, noce canaletto, erable grigio), in essenza con decoro "Wave" o in marmo.

Gold plated metal base; top available in lacquered wood, in wood veneer (makassar ebony, canaletto walnut, grey erable), wood veneer with "Wave" decoration or marble.

Позолоченная металлическая основа, доступна столешница из лакированной древесины, деревянного шпона (макаassarский эбен, орех каналетто, серый клен), деревянного шпона с отделкой «волна» или из мрамора.

镀金金属底座；桌面可选漆木、实木（望加锡乌木、卡纳莱托胡桃木、灰雀眼木）、“波纹”装饰实木饰面或大理石。

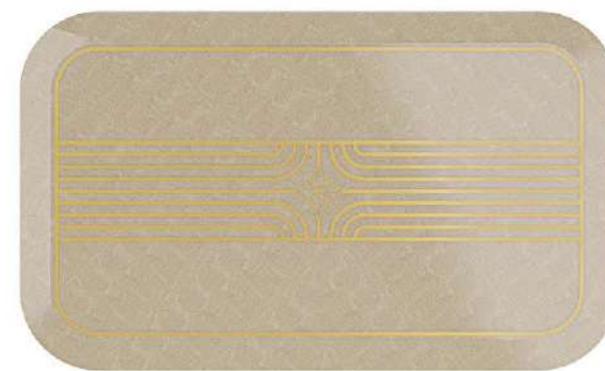

As picture: Triton central table
In price list: Brilliant

Lucidatura/Finishing/Отделка/饰面
65. MAKASSAR
Parti in metallo/Metal parts/Металлическая фурнитура/金属部件
GOLD

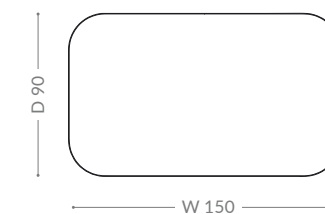
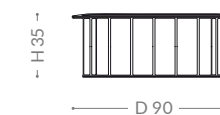
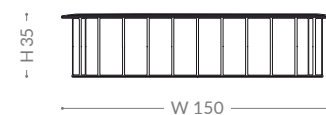

As picture: Triton central table
In price list: Brilliant/Wave decoration

Lucidatura/Finishing/Отделка/饰面
74. ERABLE GREY

Decorazione/Decoration/
Декоративный элемент/装饰
WAVE GOLD

Parti in metallo/Metal parts/Металлическая фурнитура/金属部件
GOLD

TRITON

SQUARE TABLE

S O F A T A B L E S



As picture: Triton square table
In price list: Brilliant

Lucidatura/Finishing/Отделка/饰面
65. MAKASSAR

Parti in metallo/Metal parts/Металлическая фурнитура/金属部件
GOLD

Base in metallo placcato oro; disponibile con piano in legno laccato, in essenza (ebano makassar e noce canaletto) o in marmo.

Gold plated metal base; top available in lacquered wood, in wood veneer (makassar ebony, canaletto walnut) or marble.

Позолоченная металлическая основа, доступна столешница из лакированной древесины, деревянного шпона (макassarский эбен, орех каналетто) или мрамора.

镀金金属底座；桌面可选漆木、实木饰面（望加锡乌木、卡纳莱托胡桃木）或大理石。

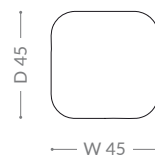
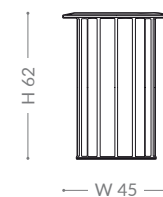

TRITON

ROUND TABLE 45



As picture: Triton round table 45
In price list: Brilliant

Lucidatura/Finishing/Отделка/饰面
69. CANALETTO WALNUT

Parti in metallo/Metal parts/Металлическая фурнитура/金属部件
GOLD

Base in metallo placcato oro; disponibile con piano in legno laccato, in essenza (ebano makassar e noce canaletto) o in marmo.

Gold plated metal base; top available in lacquered wood, in wood veneer (makassar ebony, canaletto walnut) or marble.

Позолоченная металлическая основа, доступна столешница из лакированной древесины, деревянного шпона (макassarский эбен, орех каналетто) или мрамора.

镀金金属底座；桌面可选漆木、实木饰面（望加锡乌木、卡纳莱托胡桃木）或大理石。

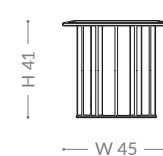

S O F A T A B L E S

TRITON

ROUND TABLE 60

S O F A T A B L E S



As picture: Triton round table 60
In price list: Precious stone



Marmo/Marble/Мрамор/大理石
EMPERADOR DARK



Parti in metallo/Metal parts/Металлическая фурнитура/金属部件
GOLD

Base in metallo placcato oro; disponibile con piano in legno laccato, in essenza (ebano makassar e noce canaletto) o in marmo.

Gold plated metal base; top available in lacquered wood, in wood veneer (makassar ebony, canaletto walnut) or marble.

Позолоченная металлическая основа, доступна столешница из лакированной древесины, деревянного шпона (макassarский эбен, орех каналетто) или мрамора.

镀金金属底座；桌面可选漆木、实木饰面（望加锡乌木、卡纳莱托胡桃木）或大理石。

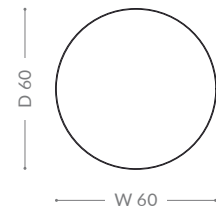
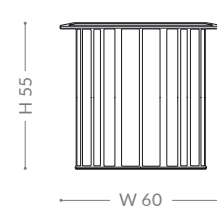

TRITON

COURTESY TABLE



As picture: Triton courtesy table
In price list: Brilliant

Lucidatura/Finishing/Отделка/饰面
54. GREY



Parti in metallo/Metal parts/Металлическая фурнитура/金属部件
GOLD



Base in metallo placcato oro; disponibile con piano in legno laccato o in marmo.

Gold plated metal base; top available in lacquered wood or marble.

Позолоченная металлическая основа, доступна столешница из лакированной древесины или мрамора.

镀金金属底座；桌面可选用漆木或大理石。

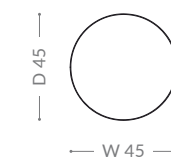
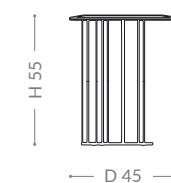
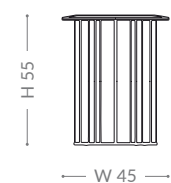

S O F A T A B L E S

TULIP

ROUND TABLE

SOFA TABLES



As picture: Tulip round table
In price list: Prime



Piano/Top/Столешница/桌面
BRONZE GLASS



Parti in metallo/Metal parts/Металлическая фурнитура/金属部件
SATIN GOLD

Struttura in metallo; finitura disponibile oro satin. Piano in vetro bronzo (taglio brillante).

Metal frame; available in satin gold finishing. Bronze glass top (diamond beveled edge).

Металлический каркас, золотистая глянцевая отделка. Столешница из бронзового стекла (с фасетированным краем).

金属框架；缎面金色饰面。青铜色玻璃桌面（菱形斜边）。

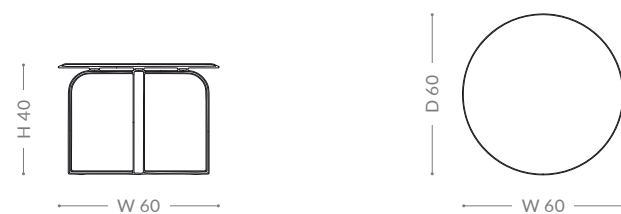

TULIP

SIDE TABLE 35+45



As picture: Tulip side table 35+45
In price list: Prime

Lucidatura/Finishing/Отделка/饰面
93. WENGÉ MATT



Parti in metallo/Metal parts/Металлическая фурнитура/金属部件
SATIN TITANIUM

Struttura in metallo, finitura disponibile titanio satin. Piano disponibile in noce canaletto.

Metal frame; available in satin titanium finishing. Top available in canaletto walnut wood.

Металлический каркас, глянцевая титановая отделка. Деревянная столешница из ореха каналетто.

金属框架；缎面钛合金饰面。选用卡纳莱托胡桃木桌面。

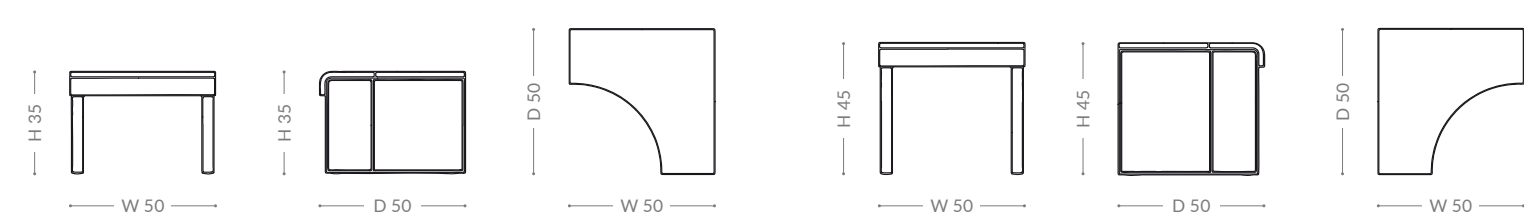

SOFA TABLES

TULIP

TRIS SET

SOFA TABLES



As picture: Tulip tris table
(Tulip round table+Tulip side table 35+Tulip side table 45)
In price list: Brilliant

Struttura in metallo; finitura satin. Piano in vetro bronzo (taglio brillante) per tavolino rotondo; piano in noce canaletto per tavolini laterali.

Metal frame, satin finishing. Bronze glass top (diamond beveled edge) for round table; canaletto walnut wooden top for side tables.



Piano/Top/Столешница/桌面
BRONZE GLASS (round table)
69. CANALETTO WALNUT (side tables)

Металлический каркас, глянцевая отделка. Столешница из бронзового стекла (с фацетированным краем) для круглого столика; столешница из ореха каналетто для приставных столов.

Parti in metallo/Metal parts/Металлическая фурнитура/金属部件
SATIN GOLD (round table)
SATIN TITANIUM (side table)

金属框架，缎面饰面。圆桌为青铜色玻璃桌面（带有菱形斜边）；茶几为卡纳莱托胡桃木桌面。

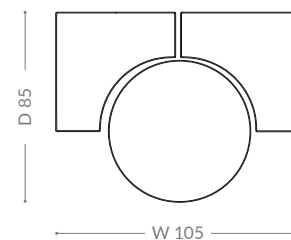
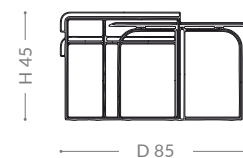
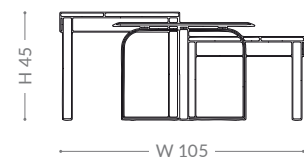

WAVE

CENTRAL TABLE



As picture: Wave central table
In price list: Prime

Struttura in essenza di noce canaletto. Piano in legno laccato.

Lucidatura/Finishing/Отделка/饰面
93. WENGÉ MATT
100. GREY MATT

Canaletto walnut wooden frame. Lacquered wooden top.



SOFA TABLES

Каркас из древесины ореха каналетто. Столешница из лакированной древесины.

卡纳莱托胡桃木框架。漆木桌面。

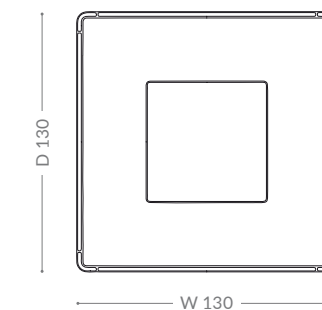
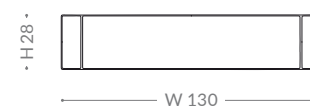

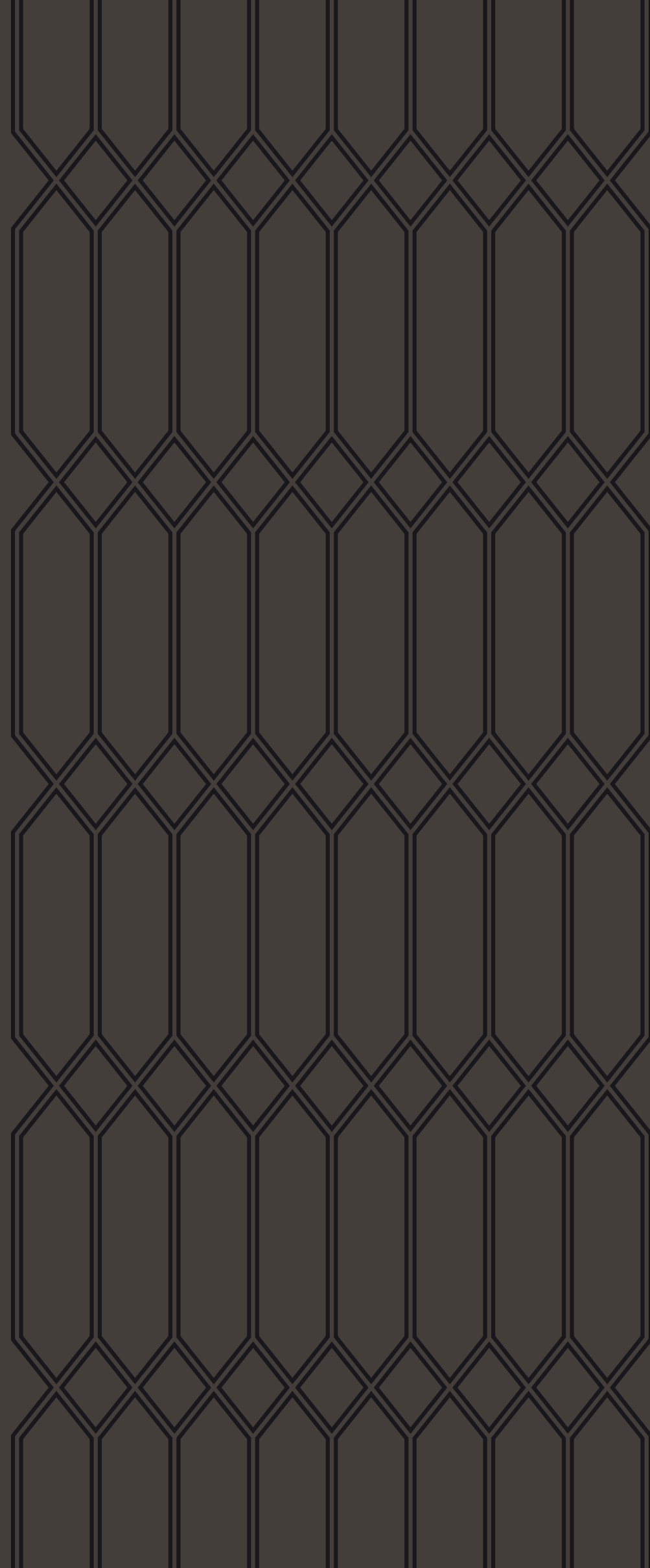

ZB

DINING TABLES



BOSTON

RECTANGULAR DINING TABLE



Struttura in legno massello. Base unica in legno con decori in ottone. Piano disponibile in noce canaletto o ebano makassar, con inserto in marmo o onice. Decorazioni perimetrali in metallo.

Solid wood frame. Single wooden base with brass decoration. Top available in canaletto walnut or makassar ebony veneer, with marble or onyx inlay. Top edge metal profile.

Каркас из массива дерева. Деревянная основа с одной ножкой и отделкой из латуни. Доступна столешница из шпона макассарского эбена или ореха каналетто со вставкой из мрамора или оникса. Металлический профиль верхней кромки.

实木框架。黄铜装饰木制单底座。桌面可选用望加锡乌木或卡纳莱托胡桃木饰面板（镶大理石或缟玛瑙）。金属型材桌边。

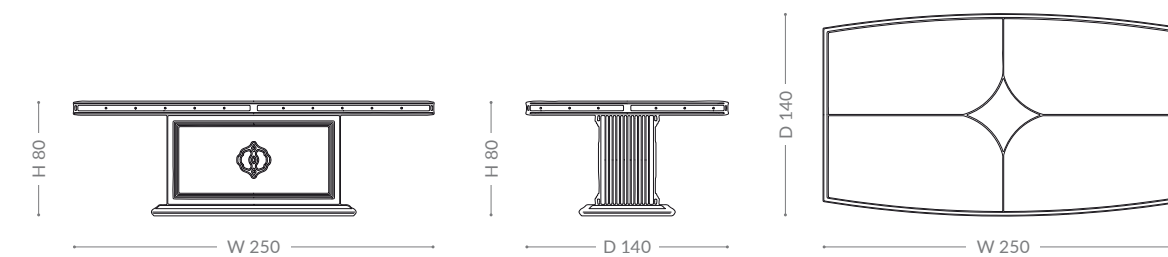

BOSTON
rectangular cm 250

DINING TABLES

As picture: Boston rectangular dining table
In price list: Brilliant

Lucidatura/Finishing/Отделка/饰面
94. TAUPE - 98. WENGÉ
61. DIAMOND GOLD

Marmo/Marble/Мрамор/大理石
BRONZE AMANI

Parti in metallo/Metal parts/Металлическая фурнитура/金属部件
GOLD

BOSTON WIDE

RECTANGULAR DINING TABLE

Struttura in legno massello. Due basi in legno con decori in ottone. Piano disponibile in noce canaletto o ebano makassar, con inserto in marmo o onice. Decorazioni perimetrali in metallo.

Solid wood frame. Two wooden bases with brass decoration. Top available in canaletto walnut or makassar ebony veneer, with marble or onyx inlay. Top edge metal profile.

Каркас из массива дерева. Две деревянные основы с отделкой из латуни. Доступна столешница из шпона макаassarского эбена или ореха каналетто со вставкой из мрамора или оникса. Металлический профиль верхней кромки.

实木框架。黄铜装饰木制双底座。桌面可选加锡乌木或卡纳莱托胡桃木饰面板（镶大理石或缟玛瑙）。桌面边缘金属型材。

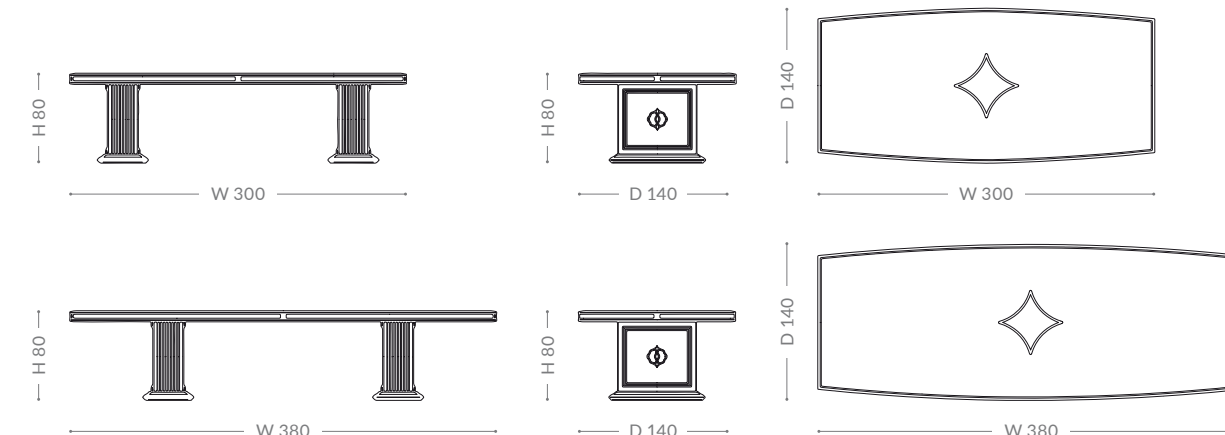

BOSTON WIDE rectangular cm 300

BOSTON WIDE rectangular cm 380

DINING TABLES

As picture: Boston Wide rectangular dining table cm 380
In price list: Brilliant

Lucidatura/Finishing/Отделка/饰面
57. CHOCOLATE
61. DIAMOND GOLD - 65. MAKASSAR

Marmo/Marble/Мрамор/大理石
ONYX HONEY

Parti in metallo/Metal parts/Металлическая фурнитура/金属部件
GOLD

BOSTON

ROUND DINING TABLE



Struttura in legno massello. Base in legno con decori in ottone. Piano disponibile in noce canaletto o ebano makassar, con inserto in marmo o onice. Decorazioni perimetrali in metallo. "Lazy Susan" su richiesta.

Solid wood frame. Wooden base with brass decoration. Top available in canaletto walnut or makassar ebony veneer, with marble or onyx inlay. Top edge metal profile. "Lazy Susan" on request.

Каркас из массива дерева. Деревянная основа с отделкой из латуни. Доступна столешница из шпона макаassarского эбена или ореха каналетто со вставкой из мрамора или оникса. Металлический профиль верхней кромки. Вращающаяся подставка по запросу.

实木框架。黄铜装饰木制底座。桌面可选加锡乌木或卡纳莱托胡桃木饰面板（镶大理石或玛瑙）。桌面边缘金属型材。可根据要求定制“餐桌转盘”。

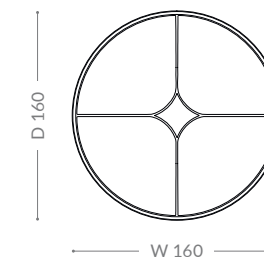
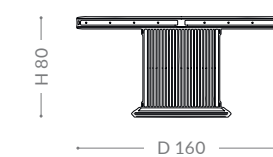
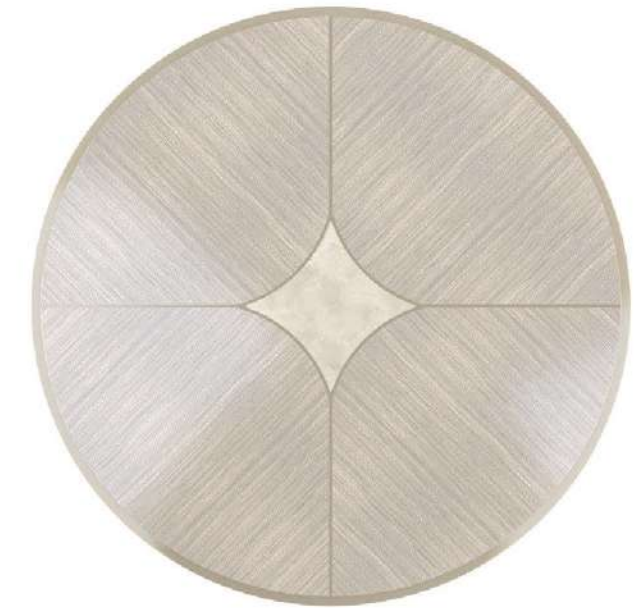

BOSTON round cm 160

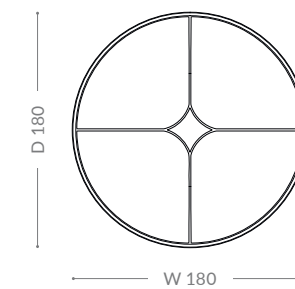
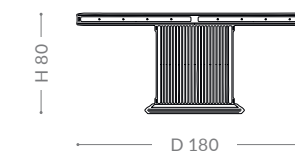
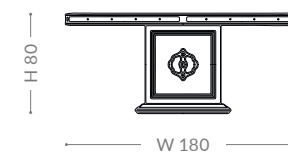

BOSTON round cm 180

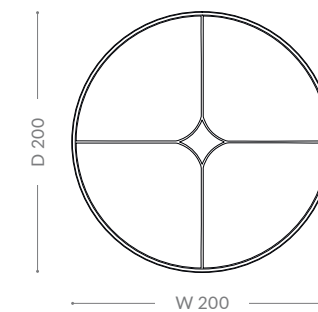
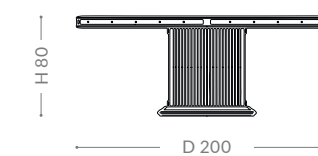
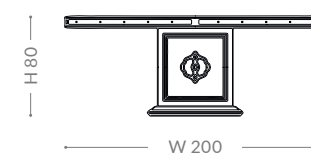

BOSTON round cm 200

DINING TABLES

As picture: Boston round dining table cm 180
In price list: Brilliant/Lazy Susan on request

Lucidatura/Finishing/Отделка/饰面
53. DOVE GREY
63. WHITENED CANALETTO WALNUT

Marmo/Marble/Мрамор/大理石
ONYX WHITE

Parti in metallo/Metal parts/Металлическая фурнитура/金属部件
TITANIUM

GILLON

EXTENSIBLE DINING TABLE

Struttura in metallo satinato e legno noce canaletto massello. Piano disponibile in essenza di noce canaletto o marmo. Il tavolo è fornito con 2 allunghe da cm 50.

Satin metal and solid canaletto walnut frame. Top available in canaletto walnut veneer or marble. With two cm 50 length extensions.

Каркас из массива дерева. Каркас из глянцевого металла и массива ореха каналетто. Доступна столешница из шпона ореха каналетто или из мрамора. С двумя выдвижными поверхностями длиной 50 см.

缎面金属及卡纳莱托胡桃木实木框架。桌面可选卡纳莱托胡桃木饰面板或大理石。两个50 cm 长延长桌面。

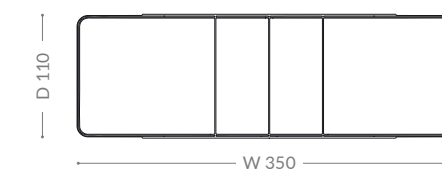
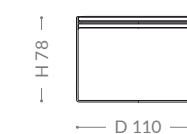
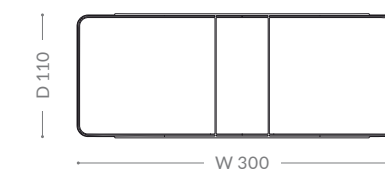
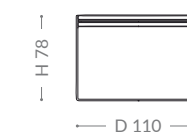
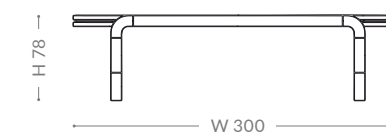
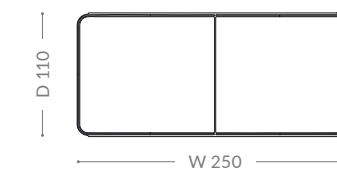
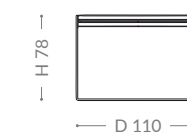
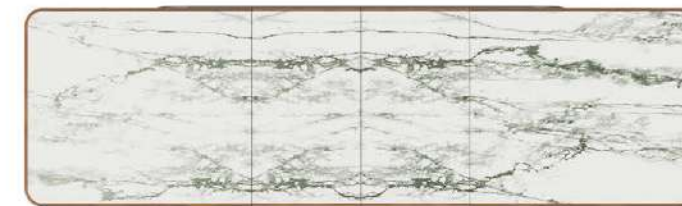
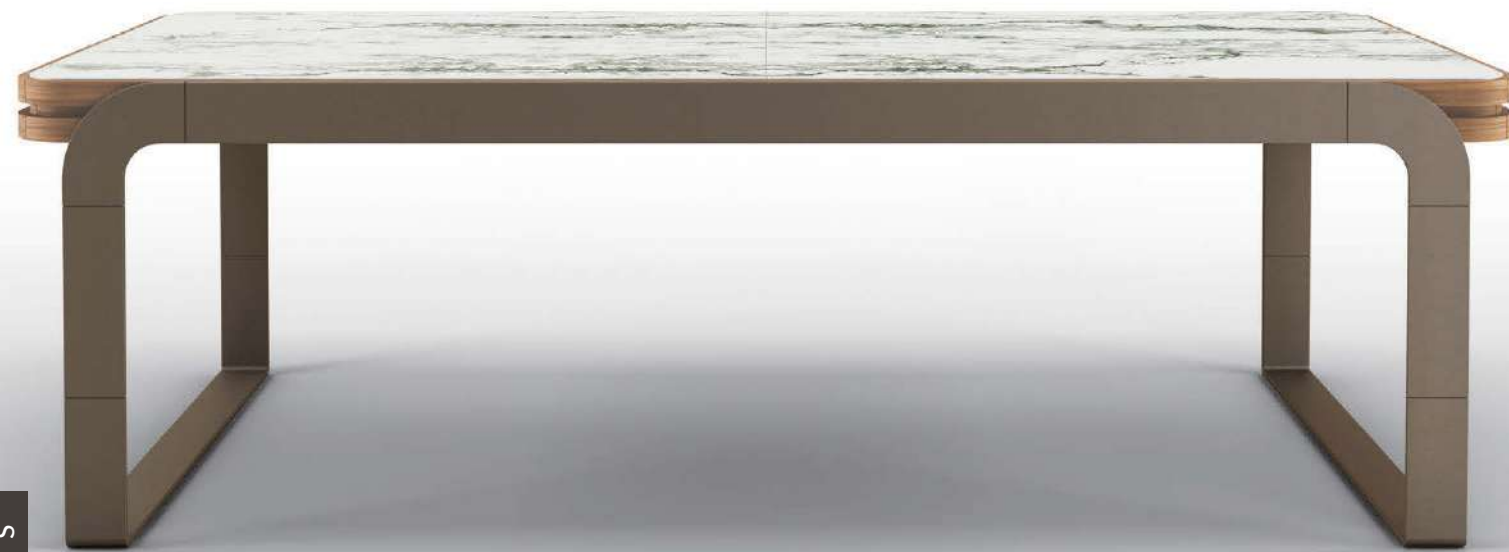

GILLON
extensible cm 250/300/350

DINING TABLES

As picture: Gillon extensible dining table
In price list: Prime/Precious stone

Lucidatura/Finishing/Отделка/饰面
70. CANALETTO WALNUT MATT

Marmo/Marble/Мрамор/大理石
IRISH CALACATTA MATT

Parti in metallo/Metal parts/Металлическая фурнитура/金属部件
SATIN TITANIUM

MANHATTAN

RECTANGULAR DINING TABLE



DINING TABLES

As picture: Manhattan rectangular dining table cm 280
In price list: Brilliant

Lucidatura/Finishing/Отделка/饰面
58. BLACK
63. WHITENED CANALETTO WALNUT

Struttura in legno massello.
Piano disponibile in noce
canaletto decorato. Disponibile
con allunghe.

Solid wood frame. Top
available in decorated
canaletto walnut veneer.
Available with length
extensions.

Каркас из массива дерева.
Доступна столешница с
отделкой из шпона ореха
каналетто. Доступна с
выдвижными поверхностями.

实木框架。桌面可选卡纳莱托
胡桃木饰面板，可选延长桌
面。

As picture: Manhattan
extensible cm 280/330/380

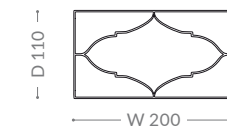
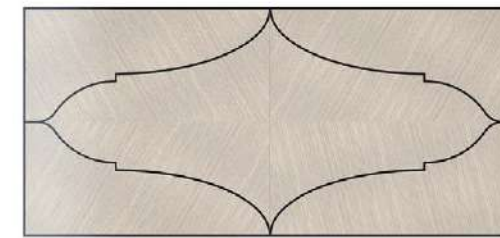

MANHATTAN
rectangular cm 200

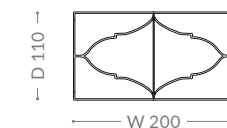

MANHATTAN
rectangular
extensible cm 200/250

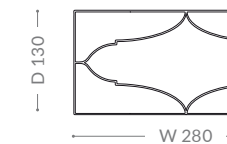
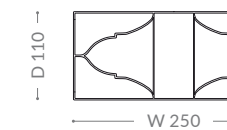
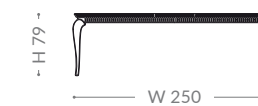

MANHATTAN
rectangular cm 280

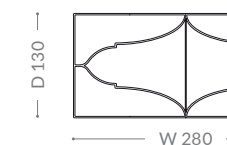

MANHATTAN
rectangular
extensible cm 280/330/380

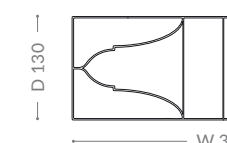
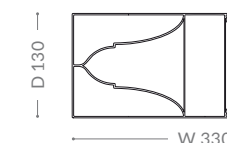

METROPOLIS

ELLIPTICAL DINING TABLE



Struttura in legno massello. Base unica in legno con decori in ottone. Piano disponibile in noce canaletto o ebano makassar, con decoro laccato.

Solid wood frame. Wooden single base with brass decoration. Top available in canaletto walnut or makassar ebony veneer, with lacquered decoration.

Каркас из массива дерева. Деревянная основа с одной ножкой и отделкой из латуни. Доступна столешница из шпона макассарского эбена или ореха каналетто с лаковой отделкой.

实木框架。黄铜装饰木制单底座。桌面可选涂漆装饰的望加锡乌木或卡纳莱托胡桃木饰面板。

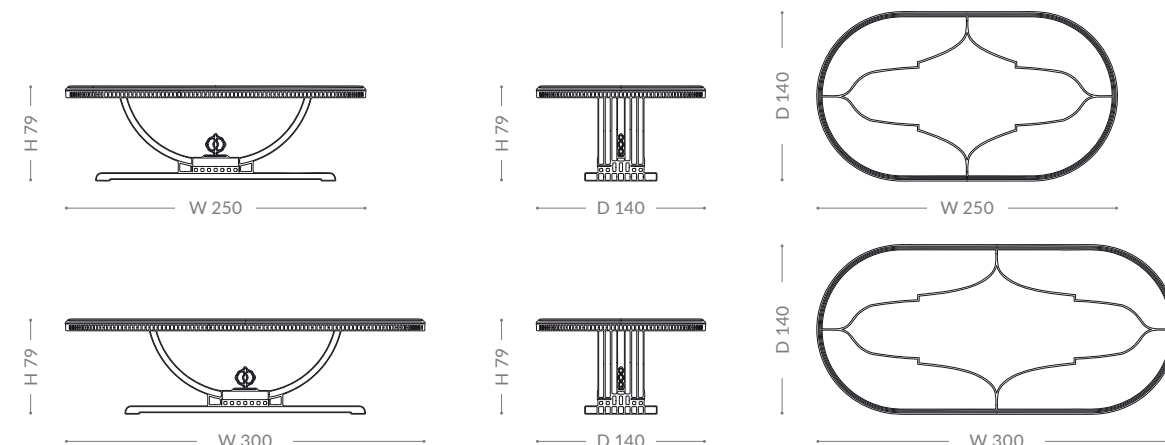

METROPOLIS
elliptical cm 250

METROPOLIS
elliptical cm 300

As picture: Metropolis elliptical dining table cm 300
In price list: Brilliant

Lucidatura/Finishing/Отделка/饰面
51. SAND
63. WHITENED CANALETTO WALNUT
88. DIAMOND TITANIUM

Parti in metallo/Metal parts/Металлическая фурнитура/金属部件
88. DIAMOND TITANIUM

METROPOLIS WIDE

ELLIPTICAL DINING TABLE

Struttura in legno massello. Due basi in legno con decori in ottone. Piano disponibile in noce canaletto o ebano makassar, con decoro laccato.

Solid wood frame. Two wooden bases with brass decoration. Top available in canaletto walnut or makassar ebony veneer, with lacquered decoration.

Каркас из массива дерева. Две деревянные основы с отделкой из латуни. Доступна столешница из шпона макассарского эбано или ореха каналетто с лаковой отделкой.

实木框架。黄铜装饰木制双底座。桌面可选涂漆装饰的望加锡乌木或卡纳莱托胡桃木饰面板。

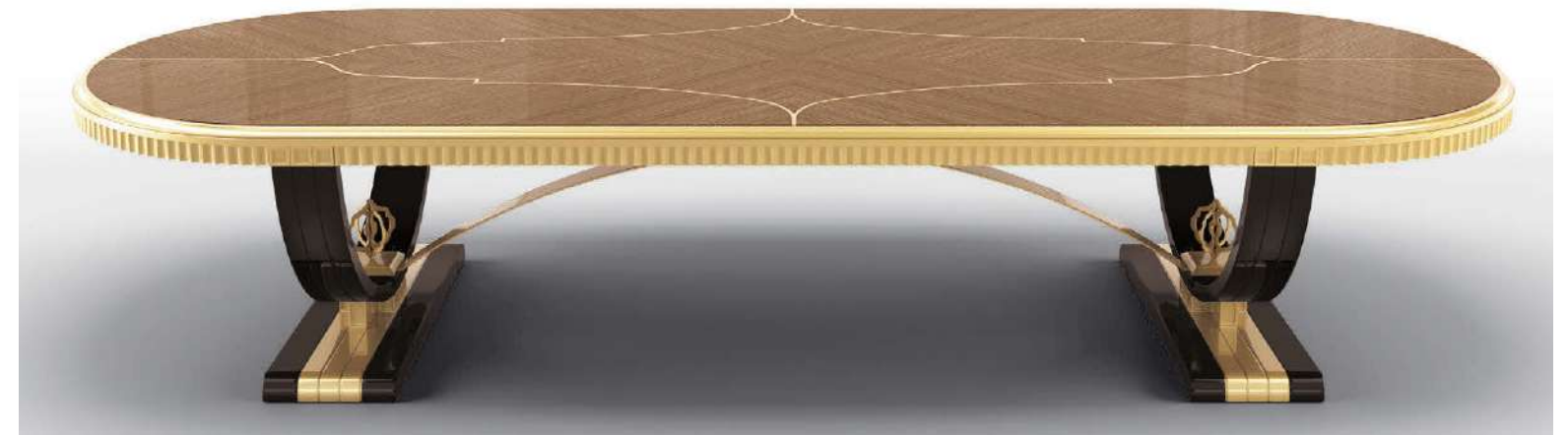

DINING TABLES

As picture: Metropolis Wide elliptical dining table cm 400
In price list: Brilliant

Lucidatura/Finishing/Отделка/饰面
57. CHOCOLATE
64. CANALETTO WALNUT
61. DIAMOND GOLD

Parti in metallo/Metal parts/Металлическая фурнитура/金属部件
61. DIAMOND GOLD

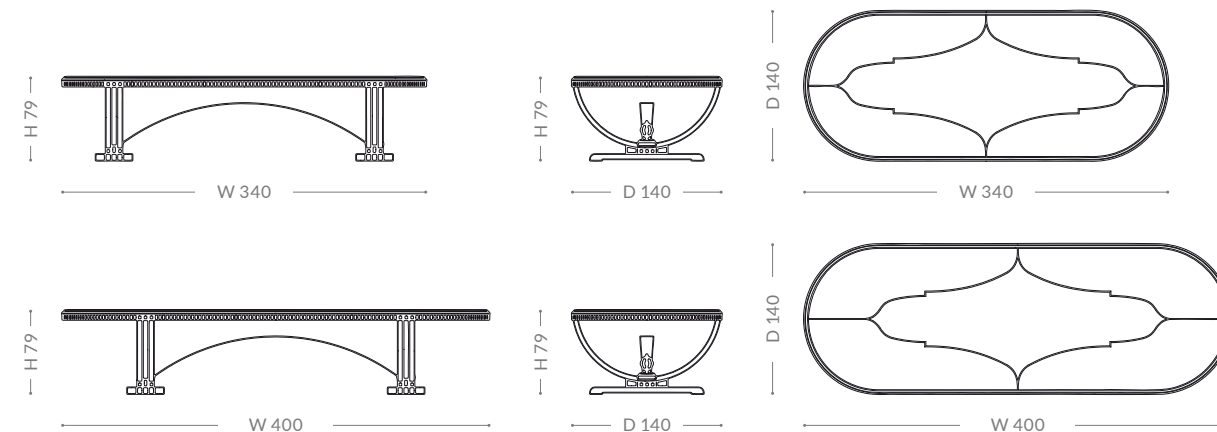

METROPOLIS WIDE elliptical cm 340

METROPOLIS WIDE elliptical cm 400

METROPOLIS

ROUND DINING TABLE

Struttura in legno massello. Base in legno con decori in ottone. Piano disponibile in noce canaletto o ebano makassar, con decorazione laccata. "Lazy Susan" su richiesta.

Solid wood frame. Wooden base with brass decoration. Top available in canaletto walnut or makassar ebony veneer, with lacquered decoration. "Lazy Susan" on request.

Каркас из массива дерева. Деревянная основа с отделкой из латуни. Доступна столешница из шпона макассарского эбена или ореха каналетто с лаковой отделкой. Вращающаяся подставка по запросу.

实木框架。黄铜装饰木制底座。桌面可选涂漆装饰的望加锡乌木或卡纳莱托胡桃木饰面板。可根据要求定制“餐桌转盘”。

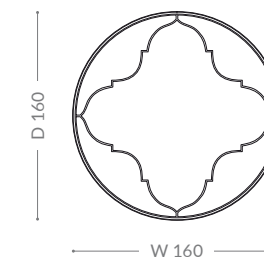
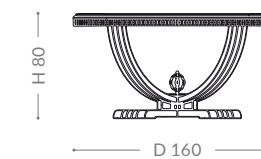
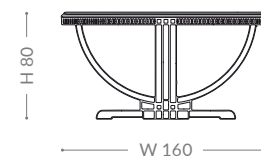

METROPOLIS round cm 160

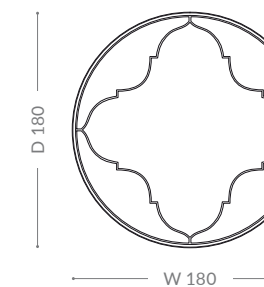
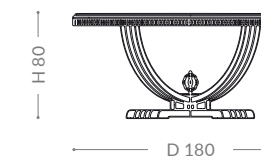
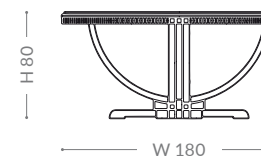

METROPOLIS round cm 180

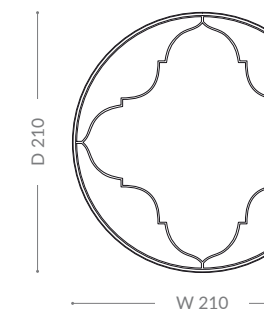
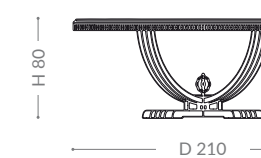
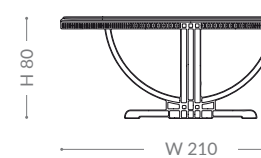

METROPOLIS round cm 210

As picture: Metropolis round dining table cm 180
In price list: Brilliant/Lazy Susan on request

Lucidatura/Finishing/Отделка/饰面
53. DOVE GREY
63. WHITENED CANALETTO WALNUT

Parti in metallo/Metal parts/Металлическая фурнитура/金属部件
53. DOVE GREY

MILLENIUM

ROUND DINING TABLE



As picture: Millemium round dining table cm 180
In price list: Brilliant/Lazy Susan on request

Lucidatura/Finishing/Отделка/饰面
57. CHOCOLATE
65. MAKASSAR

Parti in metallo/Metal parts/Металлическая фурнитура/金属部件
GOLD

Materiale/Material/Материал/材料
BZ 906-2030 LEATHER BURGUNDY

Struttura in metallo e legno laccato. Base decorata in pelle ricamata. Piano disponibile in essenza di ebano makassar. "Lazy Susan" disponibile su richiesta.

Metal and lacquered wooden frame. Quilted leather base. Top available in makassar ebony veneer. "Lazy Susan" on request.

Каркас из металла и древесины. Стеганая кожаная основа. Столешница из шпона макассарского эбена. Вращающаяся подставка по запросу.

金属和漆木框架。绗缝皮革底座。望加锡乌木桌面饰面板。可根据要求定制“餐桌转盘”。

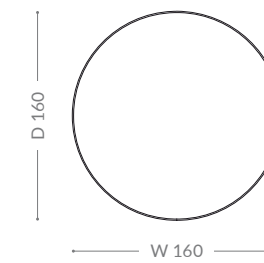
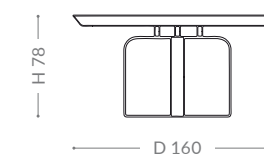
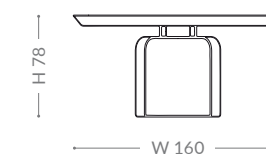

MILLENIUM
round cm 160

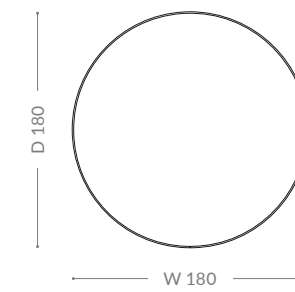
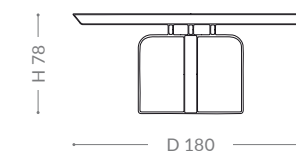
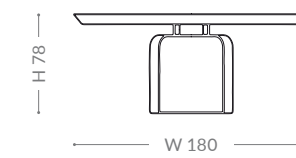

MILLENIUM
round cm 180

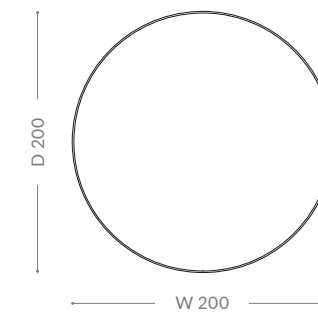
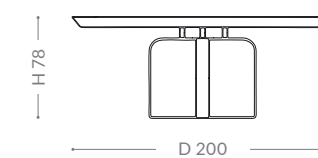
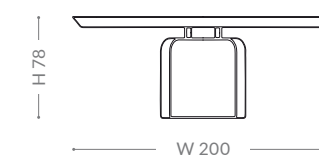

MILLENIUM
round cm 200

MILLENIUM

RECTANGULAR DINING TABLE

Struttura in metallo e legno laccato. Base decorata in pelle ricamata. Piano disponibile in essenza di ebano makassar.

Metal and lacquered wood frame. Quilted leather base. Top available in makassar ebony veneer.

Каркас из металла и лакированной древесины. Стеганая кожаная основа. Столешница из шпона макассарского эбена.

金属和漆木框架。绗缝皮革底座。桌面为望加锡乌木饰面。

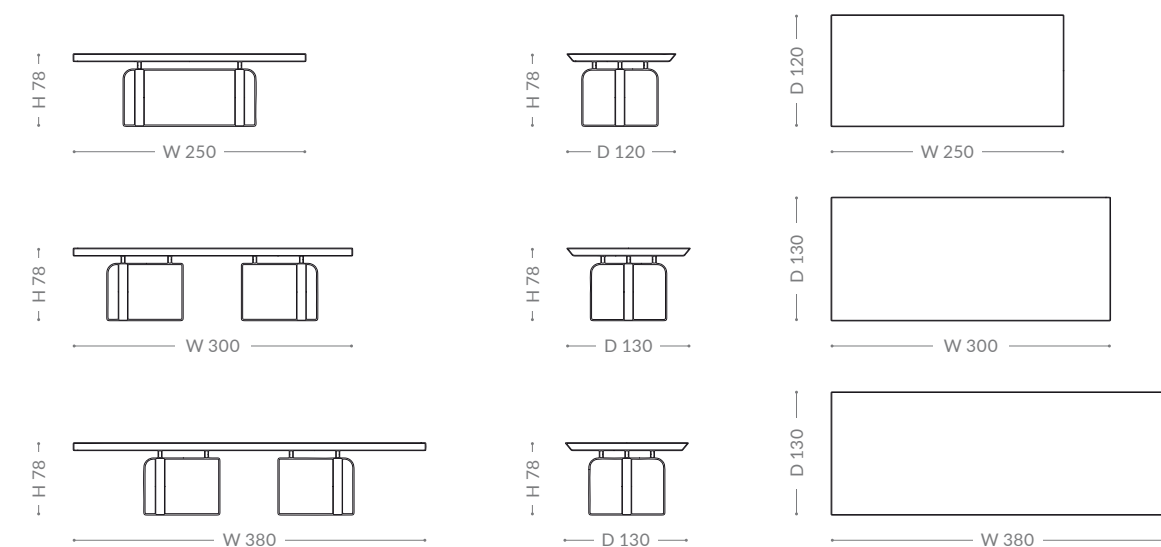

DINING TABLES

As picture: Millemium rectangular dining table cm 300
In price list: Brilliant

Lucidatura/Finishing/Отделка/饰面
57. CHOCOLATE
65. MAKASSAR

Parti in metallo/Metal parts/Металлическая фурнитура/金属部件
GOLD

Materiale/Material/Материал/材料
BZ 905-5234 LEATHER BEIGE

MILLENIUM
rectangular cm 380

OMEGA

CRYSTAL RECTANGULAR DINING TABLE



Struttura in legno e metallo.
Base decorata in pelle
ricamata. Piano disponibile
in vetro color bronzo con
lavorazione a brillante sul
perimetro.

Metal and wooden frame.
Quilted leather base. Top
available in bronze glass with
diamond beveled edge.

Каркас из металла и
древесины. Стеганая
кожаная основа. Доступна
столешница из бронзового
стекла с фацетированным
краем.

金属木制框架。绗缝皮革底
座。桌面可选用青铜色菱形斜
边玻璃。

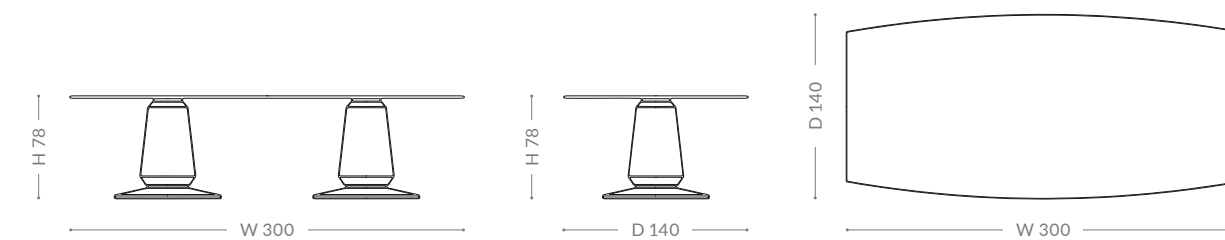

OMEGA
crystal rectangular cm 300

DINING TABLES

As picture: Omega crystal
rectangular dining table
In price list: Brilliant

Lucidatura/Finishing/Отделка/饰面
95. CARMEL

Parti in metallo/Metal parts/Метал-
лическая фурнитура/金属部件
GOLD

Materiale/Material/Материал/
材料
BZ 906-2023 LEATHER CARMEL

OMEGA

EBONY RECTANGULAR DINING TABLE

Struttura in legno e metallo.
Base decorata in pelle
ricamata. Piano disponibile in
essenza di ebano makassar.

Metal and wooden frame.
Quilted leather base. Top
available in makassar ebony
veneer.

Каркас из металла и
древесины. Стеганая
кожаная основа.
Столешница из шпона
макassarского эбена.

金属和木质框架。绗缝皮革底
座。桌面为望加锡乌木饰面。



DINING TABLES

As picture: Omega ebony rectangular dining table cm 380
In price list: Brilliant

Lucidatura/Finishing/Отделка/饰面
56. BROWN
65. MAKASSAR

Parti in metallo/Metal parts/Металлическая фурнитура/金属部件
TITANIUM

Materiale/Material/Материал/材料
BZ 906-2003 LEATHER DARK BROWN

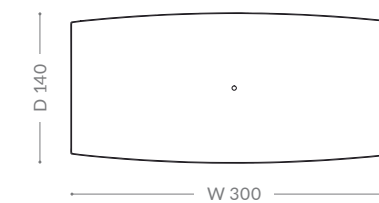
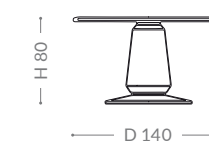
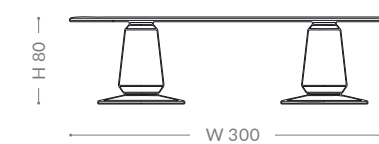

OMEGA
ebony rectangular cm 300

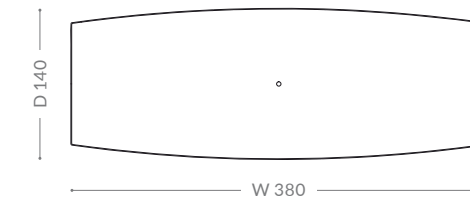
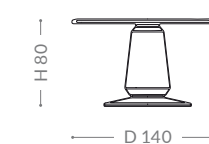
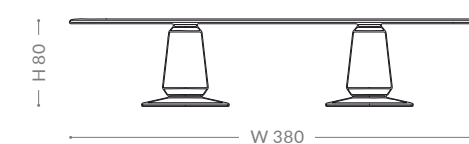

OMEGA
ebony rectangular cm 380

OMEGA

CRYSTAL ROUND DINING TABLE



Struttura in legno e metallo.
Base decorata in pelle
ricamata. Piano disponibile
in vetro color bronzo con
lavorazione a brillante sul
perimetro. "Lazy Susan"
disponibile su richiesta.

Metal and wooden frame.
Quilted leather base. Top
available in bronze glass with
diamond beveled edge.
"Lazy Susan" on request.

Каркас из металла и
древесины. Стеганая
кожаная основа. Доступна
столешница из бронзового
стекла с фацетированным
краем. Вращающаяся
подставка по запросу.

金属木制框架。绗缝皮革底
座。桌面可选用青铜色菱形斜
边玻璃。可根据要求定制“餐
桌转盘”。

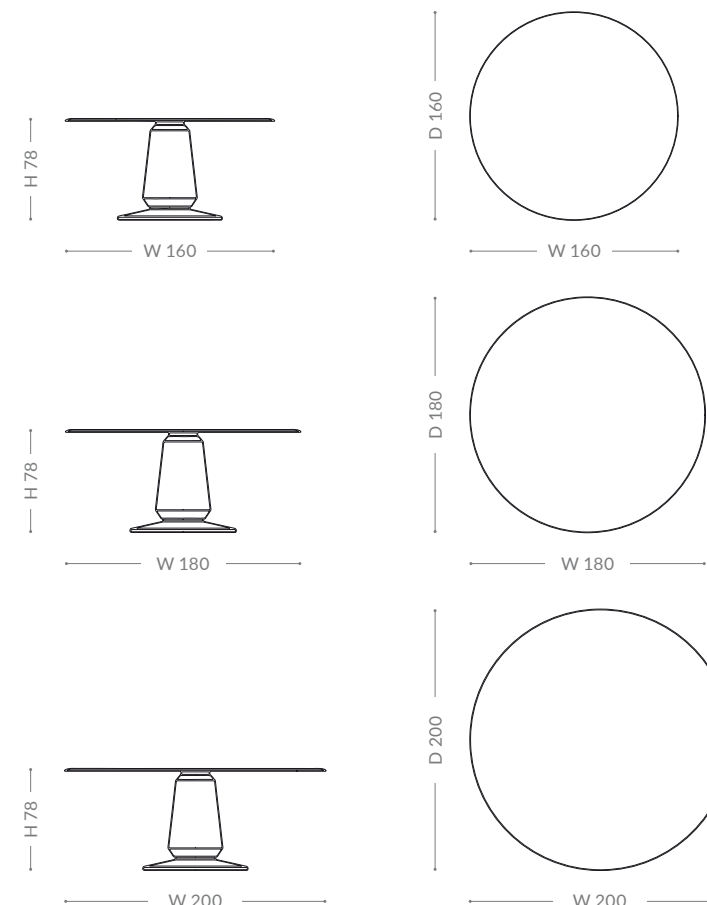

OMEGA
crystal round cm 160

OMEGA
crystal round cm 180

OMEGA
crystal round cm 200

DINING TABLES

As picture: Omega crystal
round dining table cm 180
In price list: Brilliant/Lazy
Susan on request

Lucidatura/Finishing/Отделка/饰面
57. CHOCOLATE
Lazy Susan
65. MAKASSAR

Parti in metallo/Metal parts/Метал-
лическая фурнитура/金属部件
GOLD

Materiale/Material/Материал/
材料
BZ 906-2030 LEATHER BURGUNDY

OMEGA

EBONY ROUND DINING TABLE



Struttura in legno e metallo.
Base decorata in pelle
ricamata. Piano disponibile in
essenza di ebano makassar.
"Lazy Susan" disponibile su
richiesta.

Metal and wooden frame.
Quilted leather base. Top
available in makassar ebony
veneer. "Lazy Susan" on
request.

Каркас из металла и
древесины. Стеганая
кожаная основа.
Столешница из шпона
макassarского эбена.
Вращающаяся подставка по
запросу.

金属和木质框架。绗缝皮革底
座。桌面为望加锡乌木饰面
板。可根据要求定制“餐桌转
盘”。

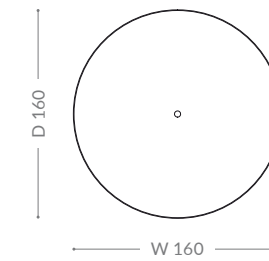
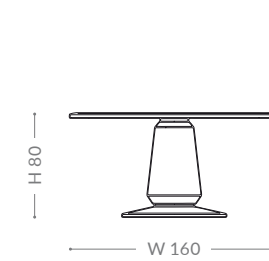

OMEGA
ebony round cm 160

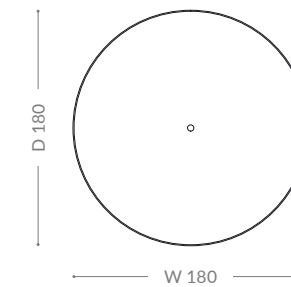
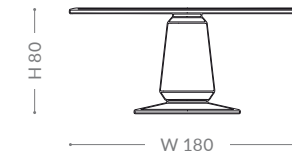

OMEGA
ebony round cm 180

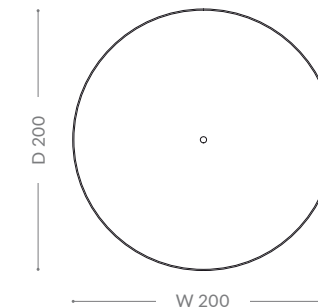

OMEGA
ebony round cm 200

DINING TABLES

As picture: Omega ebony
round dining table cm 180
In price list: Brilliant/Lazy
Susan on request

Lucidatura/Finishing/Отделка/饰面
65. MAKASSAR
54. GREY

Parti in metallo/Metal parts/Метал-
лическая фурнитура/金属部件
TITANIUM

Materiale/Material/Материал/
材料
BZ 906-2005 LEATHER OASI

ORION

ROUND DINING TABLE



Struttura in legno e metallo;
gambe in noce canaletto.
Piano disponibile in vetro
spessore mm 15. "Lazy Susan"
in legno laccato disponibile su
richiesta.

Wooden and metal frame;
canaletto walnut wooden legs.
Glass top mm 15 thick. Lac-
quered wooden "Lazy Susan"
on request.

Каркас из древесины и
металла, деревянные ножки
из ореха каналетто. Сте-
клянная столешница тол-
щиной 15 мм. Лакированная
деревянная вращающаяся
подставка по запросу.

木制金属框架；卡纳莱托胡桃
木桌腿。15mm 玻璃桌面。
可根据要求定制漆木“餐桌转
盘”。

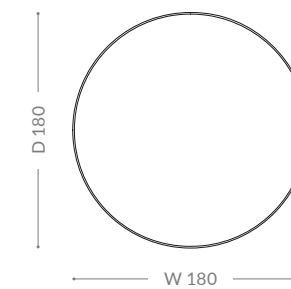
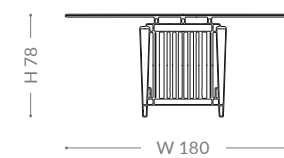

ORION
round cm 180

DINING TABLES

As picture: Orion round dining table
In price list: Brilliant/Lazy Susan on request

Lucidatura/Finishing/Отделка/饰面
54. GREY
Lazy Susan
69. CANALETTO WALNUT

Piano/Top/Столешница/桌面
EXTRA-WHITE GLASS

Parti in metallo/Metal parts/Металлическая фурнитура/金属部件
TITANIUM

ORION

RECTANGULAR DINING TABLE

Struttura in legno e metallo;
gambe in noce canaletto.
Piano disponibile in vetro
spessore mm 15.

Wooden and metal frame;
canaletto walnut wooden
legs. Glass top mm 15 thick
available.

Каркас из древесины и
металла, деревянные
ножки из ореха каналетто.
Стекло столешница
толщиной 15 мм.

木质和金属框架；卡纳莱托胡
桃木桌腿，15mm 厚玻璃桌
面。



DINING TABLES

As picture: Orion rectangu-
lar dining table cm 300
In price list: Brilliant

Lucidatura/Finishing/Отделка/饰面
69. CANALETTO WALNUT
51. SAND

Piano/Top/Столешница/桌面
EXTRA-WHITE GLASS

Parti in metallo/Metal parts/Метал-
лическая фурнитура/金属部件
GOLD

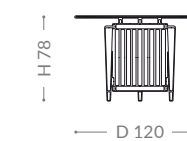
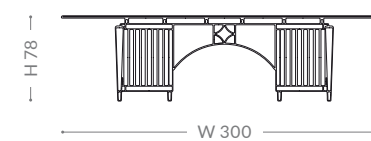

ORION
rectangular cm 300

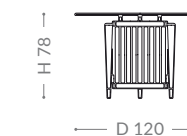
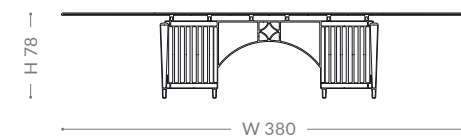

ORION
rectangular cm 380

PETRUS

RECTANGULAR DINING TABLE



Struttura e basamento in noce canaletto massello e metallo satinato. Piano disponibile in essenza di noce canaletto o marmo.

Satin metal and solid canaletto walnut frame and base. Top available in canaletto veneer or marble.

Каркас и основа из глянцевого металла и массива ореха каналетто. Доступна столешница из шпона ореха каналетто или из мрамора.

缎面金属及卡纳莱托胡桃木实木框架和底座。桌面可选用卡纳莱托胡桃木饰面板或大理石。



DINING TABLES

As picture: Petrus rectangular dining table cm 280
In price list: Prime/Precious stone

Lucidatura/Finishing/Отделка/饰面
93. WENGÉ MATT

Parti in metallo/Metal parts/Металлическая фурнитура/金属部件
SATIN GOLD

Marmo/Marble/Мрамор/大理石
CALACATTA CROMA-ARISTON

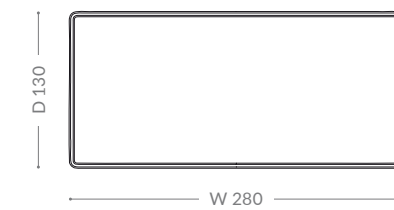
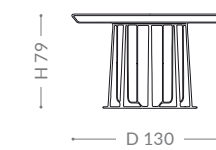
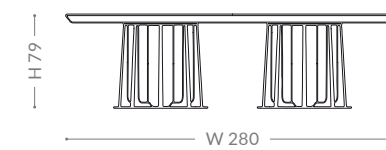

PETRUS
rectangular cm 280

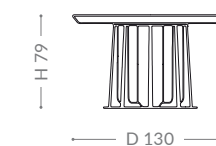
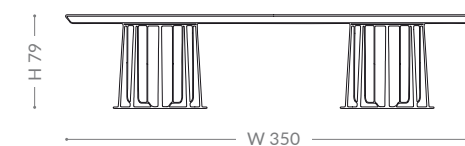

PETRUS
rectangular cm 350

PETRUS

ROUND DINING TABLE



Struttura e basamento in noce canaletto massello e metallo satinato. Piano disponibile in essenza di noce canaletto o marmo. "Lazy Susan" disponibile su richiesta.

Satin metal and solid canaletto walnut frame and base. Top available in canaletto walnut veneer or marble. "Lazy Susan" on request.

Каркас и основа из глянцевого металла и массива ореха каналетто. Доступна столешница из шпона ореха каналетто или из мрамора. Вращающаяся подставка по запросу.

缎面金属及卡纳莱托胡桃木实木框架和底座。桌面可选卡纳莱托胡桃木饰面板或大理石。可根据要求定制“餐桌转盘”。



As picture: Petrus round dining table cm 180
In price list: Brilliant/Lazy Susan on request

Lucidatura/Finishing/Отделка/饰面
69. CANALETTO WALNUT

Parti in metallo/Metal parts/Металлическая фурнитура/金属部件
SATIN GOLD

PETRUS

ROUND DINING TABLE

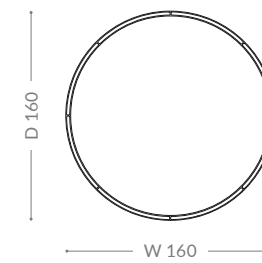
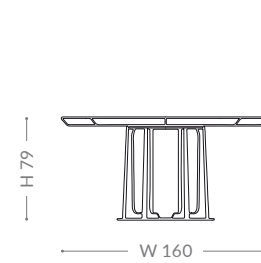

PETRUS
round cm 160

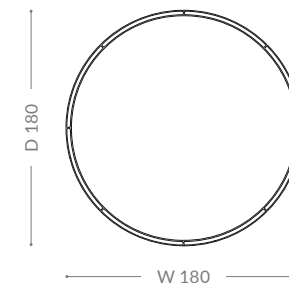
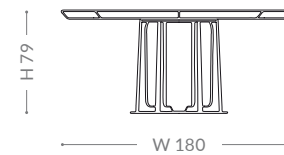

PETRUS
round cm 180

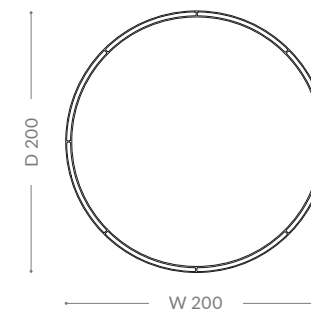
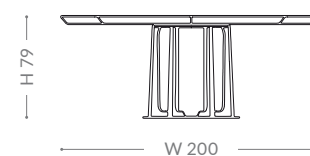

PETRUS
round cm 200

DINING TABLES

As picture: Petrus round dining table cm 200
In price list: Prime/Precious stone

Lucidatura/Finishing/Отделка/饰面
70. CANALETTO WALNUT MATT

Parti in metallo/Metal parts/Металлическая фурнитура/金属部件
SATIN TITANIUM

Marmo/Marble/Мрамор/大理石
MACAUBAS GIOTTO

WANDA

RECTANGULAR DINING TABLE



DINING TABLES

As picture: Wanda extensible rectangular dining table cm 250
In price list: Prime

Lucidatura/Finishing/Отделка/饰面
85. CHOCOLATE MATT
70. CANALETTO WALNUT MATT

Parti in metallo/Metal parts/Металлическая фурнитура/金属部件
HAMMERED GOLD

Struttura in metallo martellato e legno massello. Piano disponibile in essenza di noce canaletto. Disponibile con allunghe.

Hammered metal and solid wood frame. Top available in canaletto veneer. Available with length extensions.

Каркас из кованого металла и массива дерева. Доступна столешница из шпона ореха каналетто. Доступна с выдвигаемыми поверхностями.

锤制金属和实木框架。桌面可选用卡纳莱托胡桃木饰面板，可选延长桌面。

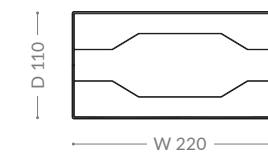
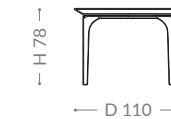
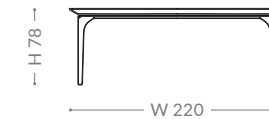

WANDA rectangular cm 220

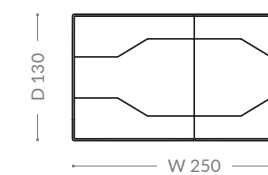
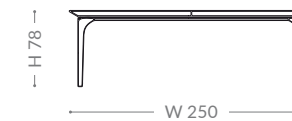

WANDA rectangular extensible cm 250/300/350

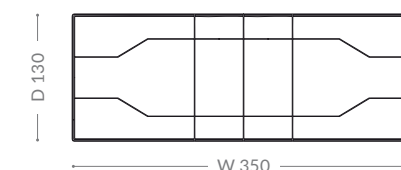
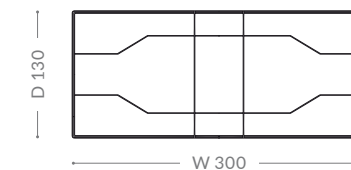
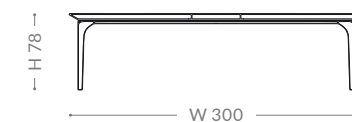

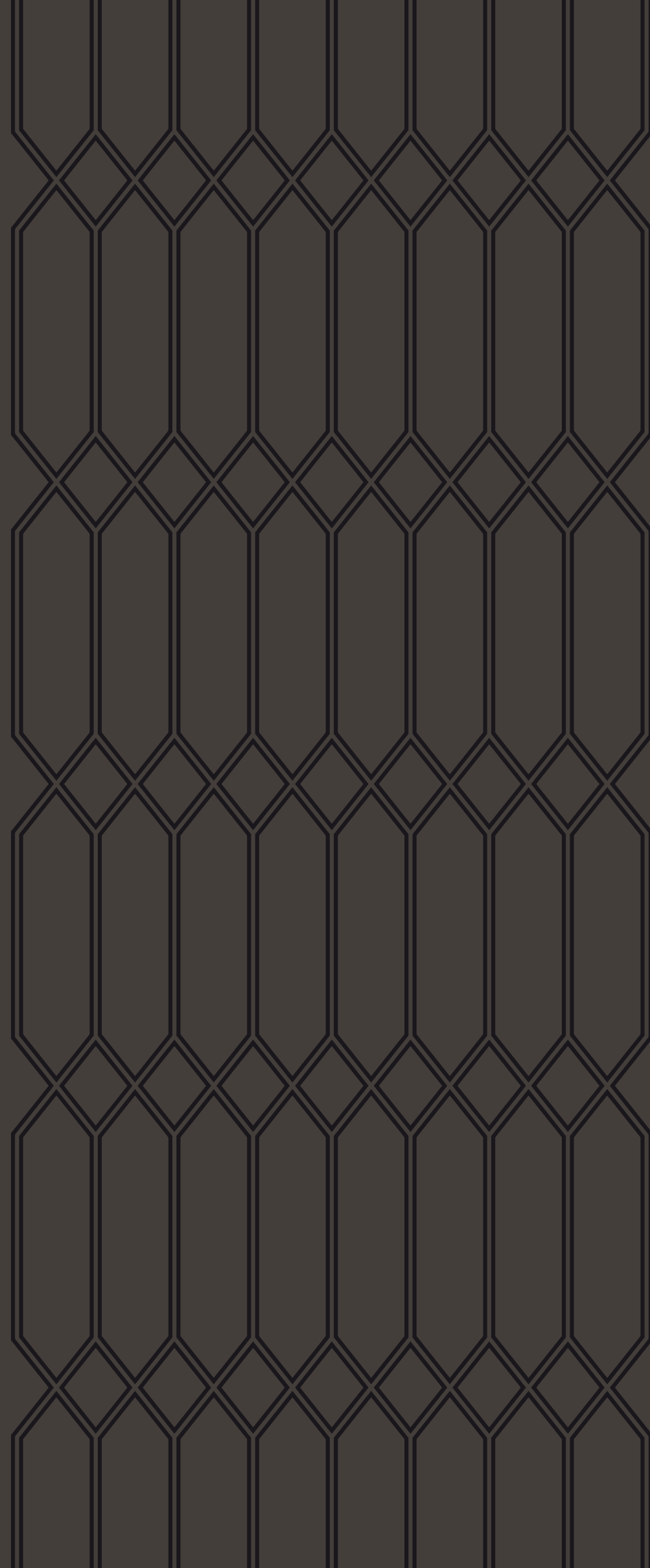

ZB

DINING CHAIRS



ARISTON

DINING CHAIR

DINING CHAIRS



As picture: Ariston dining chair
In price list: Ambition



Sedia/Chair/Стул/椅子
BZ 905-5234 LEATHER BEIGE

Parti in metallo/Metal parts/Металлическая фурнитура/金属部件
GOLD

Struttura in metallo; seduta e schienale in legno con imbottitura in poliuretano a quote differenziate. Parte esterna decorata con ricamo.

Metal frame; wooden backrest and seating, with multiple densities polyurethane foam padding.

Металлическая рама; деревянная спинка и сиденье с набивкой из пенополиуретана разной плотности. Стеганая внешняя часть корпуса.

金属框架; 木质靠背和座位, 内部填充多种密度的聚氨酯泡沫垫料。外侧部分绗缝。

ARISTON

DINING CHAIR



As picture: Ariston dining chair
In price list: Ambition



Sedia/Chair/Стул/椅子
BZ 906-2003 LEATHER DARK BROWN

Parti in metallo/Metal parts/Металлическая фурнитура/金属部件
TITANIUM

DINING CHAIRS

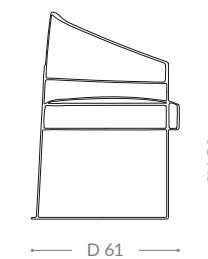
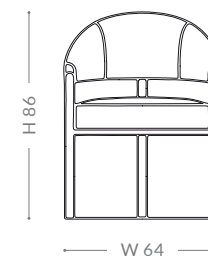

CAPRICE

DINING ARMCHAIR

DINING CHAIRS



As picture: Caprice dining armchair
In price list: Exclusive

Sedia/Chair/Стул/椅子
BZ 214-01 VELVET CARVED CARAMEL
BZ 906-2023 LEATHER CARAMEL



Lucidatura/Finishing/Отделка/饰面
85. CHOCOLATE MATT

Parti in metallo/Metal parts/Металлическая фурнитура/金属部件
GOLD

Struttura in legno massello e multistrati di legno. Guscio in pelle ricamata. Imbottitura in poliuretano a quote differenziate.

Solid wood and plywood frame. Quilted shell. Multiple densities polyurethane foam padding.

Рама из массива дерева и фанеры. Стеганая обшивка. Набивка из пенополиуретана разной плотности.

实木和胶合板框架。外部裱缝装饰。内部填充多种密度的聚氨酯泡沫垫料。

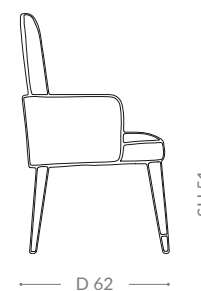
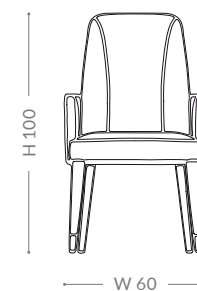

CAPRICE

DINING CHAIR



As picture: Caprice dining chair
In price list: Exclusive

Sedia/Chair/Стул/椅子
BZ 214-01 VELVET CARVED CARAMEL
BZ 906-2023 LEATHER CARAMEL



Lucidatura/Finishing/Отделка/饰面
85. CHOCOLATE MATT

Parti in metallo/Metal parts/Металлическая фурнитура/金属部件
GOLD

Struttura in legno massello e multistrati di legno. Guscio in pelle ricamata. Imbottitura in poliuretano a quote differenziate.

Solid wood and plywood frame. Quilted shell. Multiple densities polyurethane foam padding.

Рама из массива дерева и фанеры. Стеганая обшивка. Набивка из пенополиуретана разной плотности.

实木和胶合板框架。外部裱缝装饰。内部填充多种密度的聚氨酯泡沫垫料。

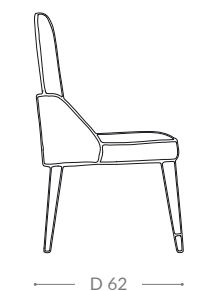
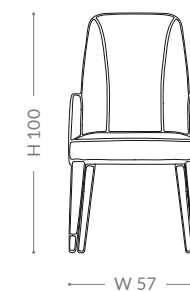

DINING CHAIRS

CELINE

DINING ARMCHAIR

DINING CHAIRS



As picture: Celine dining armchair
In price list: Ambition/Brilliant

Sedia/Chair/Стул/椅子
BZ 906-2005 LEATHER OASI



Lucidatura/Finishing/Отделка/饰面
57. CHOCOLATE

Parti in metallo/Metal parts/Металлическая фурнитура/金属部件
GOLD

Struttura in legno massello. Schienale e parte esterna ricamati. Imbottitura in poliuretano a quote differenziate.

Solid wood frame. Quilted backrest and outer body. Multiple densities polyurethane foam padding.

Рама из массива дерева. Стеганая спинка и внешняя часть каркаса. Набивка из пенополиуретана разной плотности.

实木框架。靠背和外部点缀绗缝装饰。内部填充多种密度的聚氨酯泡沫垫料。

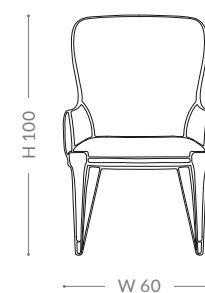

CELINE

DINING CHAIR

DINING CHAIRS



As picture: Celine dining chair
In price list: Ambition/Brilliant

Sedia/Chair/Стул/椅子
BZ 906-2005 LEATHER OASI



Lucidatura/Finishing/Отделка/饰面
57. CHOCOLATE

Parti in metallo/Metal parts/Металлическая фурнитура/金属部件
GOLD

Struttura in legno massello. Schienale e parte esterna ricamati. Imbottitura in poliuretano a quote differenziate.

Solid wood frame. Quilted backrest and outer body. Multiple densities polyurethane foam padding.

Рама из массива дерева. Стеганая спинка и внешняя часть каркаса. Набивка из пенополиуретана разной плотности.

实木框架。靠背和外部点缀绗缝装饰。内部填充多种密度的聚氨酯泡沫垫料。

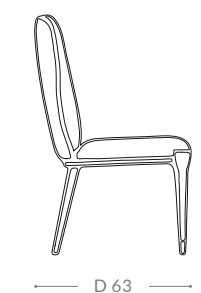
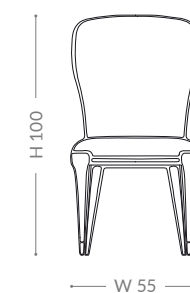

DILETTA

DINING ARMCHAIR

DINING CHAIRS



As picture: Diletta dining armchair
In price list: Ambition/Brilliant

Sedia/Chair/Стул/椅子
BZ 906-2005 LEATHER OASI



Lucidatura/Finishing/Отделка/饰面
54. GREY

Parti in metallo/Metal parts/Металлическая фурнитура/金属部件
GOLD

Struttura in legno massello e metallo. Gambe rivestite in pelle. Schienale sagomato con parte esterna e interna ricamati, finitura con borchie in pelle. Imbottitura in poliuretano a quote differenziate.

Solid wood and metal frame. Leather covered legs. Shaped backrest with quilted inner and outer body; finished with leather covered nails. Multiple densities polyurethane foam padding.

Рама из массива дерева и металла. Ножки, обтянутые кожей. Фигурная спинка со стеганой внутренней и передней частью каркаса; украшена декоративными гвоздями, обтянутыми кожей. Набивка из пенополиуретана разной плотности.

实木和金属框架。皮革椅腿。形状靠背，内外部均点缀缝装饰；饰面点缀皮革钉扣。内部填充多种密度的聚氨酯泡沫垫料。

DILETTA

DINING ARMCHAIR

DINING CHAIRS



As picture: Diletta dining armchair
In price list: Ambition/Brilliant

Sedia/Chair/Стул/椅子
BZ 906-2030 LEATHER BURGUNDY



Lucidatura/Finishing/Отделка/饰面
96. BURGUNDY

Parti in metallo/Metal parts/Металлическая фурнитура/金属部件
GOLD

DINING CHAIRS

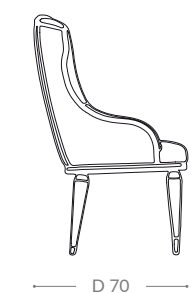
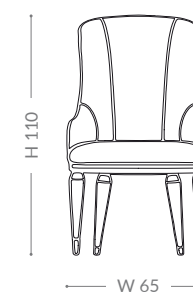

DILETTA

DINING CHAIR

DINING CHAIRS



As picture: Diletta dining chair
In price list: Ambition/Brilliant

Sedia/Chair/Стул/椅子
BZ 906-2030 LEATHER BURGUNDY



Lucidatura/Finishing/Отделка/饰面
96. BURGUNDY

Parti in metallo/Metal parts/Металлическая фурнитура/金属部件
GOLD

Struttura in legno massello e metallo. Gambe rivestite in pelle. Schienale sagomato con parte esterna e interna ricamati, finitura con borchie in pelle. Imbottitura in poliuretano a quote differenziate.

Solid wood and metal frame. Leather covered legs. Shaped backrest with quilted inner and outer body; finished with leather covered nails. Multiple densities polyurethane foam padding.

Рама из массива дерева и металла. Ножки, обтянутые кожей. Фигурная спинка со стеганой внутренней и передней частью каркаса; украшена декоративными гвоздями, обтянутыми кожей. Набивка из пенополиуретана разной плотности.

实木和金属框架。皮革椅腿。形状靠背，内外部均点缀缝线装饰；饰面点缀皮革钉扣。内部填充多种密度的聚氨酯泡沫垫料。

DILETTA

DINING CHAIR



As picture: Diletta dining chair
In price list: Ambition/Brilliant

Sedia/Chair/Стул/椅子
BZ 906-2005 LEATHER OASI



Lucidatura/Finishing/Отделка/饰面
54. GREY

Parti in metallo/Metal parts/Металлическая фурнитура/金属部件
GOLD

DINING CHAIRS

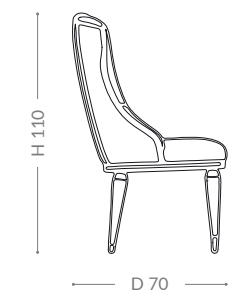
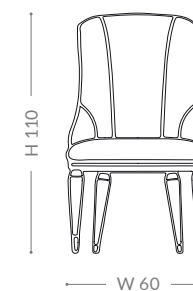

GRETA

DINING ARMCHAIR

DINING CHAIRS



As picture: Greta dining armchair
In price list: Prestige/Brilliant



Sedia/Chair/Стул/椅子
BZ 118-073 VELVET SAND
BZ 126-50 UNITO SAND/PEARL

Lucidatura/Finishing/Отделка/饰面
57. CHOCOLATE

Struttura in legno massello. Gambe, braccioli e schienale intagliati a mano; decorazione frontale e laterale in legno massello. Parte interna trapuntata a righe verticali. Imbottitura in poliuretano a quote differenziate.

Solid wood frame. Hand-carved legs, armrests and backrest; front and side solid wood decoration. Vertically decorated quilted inner body. Multiple densities polyurethane foam padding.

Рама из массива дерева. Ножки, подлокотники и спинка ручной работы; передняя и боковая отделка из массива дерева. Стеганая внутренняя часть каркаса с вертикальной отделкой. Набивка из пенополиуретана разной плотности.

实木框架。手工雕刻椅腿、扶手和靠背，正面和侧面点缀实木装饰。内里纵向褶皱装饰。内部填充多种密度的聚氨酯泡沫垫料。

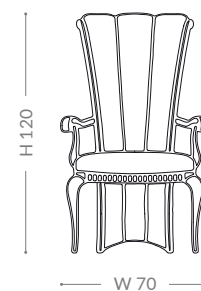

GRETA

DINING CHAIR



As picture: Greta dining chair
In price list: Prestige/Brilliant



Sedia/Chair/Стул/椅子
BZ 118-073 VELVET SAND
BZ 126-50 UNITO SAND/PEARL

Lucidatura/Finishing/Отделка/饰面
57. CHOCOLATE

Struttura in legno massello. Gambe e schienale intagliati a mano; decorazione frontale e laterale in legno massello. Parte interna trapuntata a righe verticali. Imbottitura in poliuretano a quote differenziate.

Solid wood frame. Hand-carved legs and backrest; front and side solid wood decoration. Vertically decorated quilted inner body. Multiple densities polyurethane foam padding.

Рама из массива дерева. Ножки и спинка ручной работы; передняя и боковая отделка из массива дерева. Стеганая внутренняя часть каркаса с вертикальной отделкой. Набивка из пенополиуретана разной плотности.

实木框架。手工雕刻椅腿和靠背，正面和侧面点缀实木装饰。内里纵向褶皱装饰。内部填充多种密度的聚氨酯泡沫垫料。

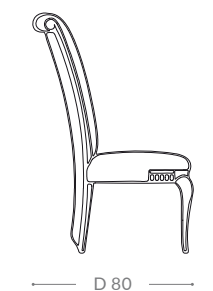
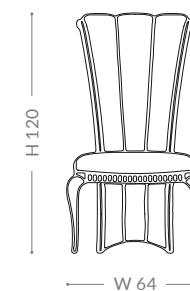

DINING CHAIRS

MARYBELL

DINING ARMCHAIR

DINING CHAIRS



As picture: Marybell dining armchair
In price list: Prestige



Sedia/Chair/Стул/椅子
BZ 191-004 JACQUARD BLUE

Lucidatura/Finishing/Отделка/饰面
70. CANALETTO WALNUT MATT

Struttura in noce canaletto massello sagomato. Decorazione *plissé* su parte esterna. Imbottitura in poliuretano a quote differenziate.

Solid canaletto walnut wooden frame. *Plissé* decoration outer body. Multiple densities polyurethane foam padding.

Рама из массива дерева цвета ореха каналетто. Внешняя часть каркаса с отделкой *плиссе*. Набивка из пенополиуретана разной плотности.

卡纳莱托胡桃木实木框架。外部褶皱装饰。内部填充多种密度的聚氨酯泡沫垫料。

MARYBELL

DINING ARMCHAIR



As picture: Marybell dining armchair
In price list: Brilliant

Sedia/Chair/Стул/椅子
BZ 217-101 VELVET DOVE GREY



Lucidatura/Finishing/Отделка/饰面
69. CANALETTO WALNUT

DINING CHAIRS

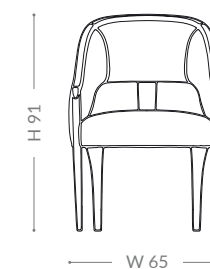

OPHELIA

DINING ARMCHAIR

DINING CHAIRS



As picture: Ophelia dining armchair
In price list: Ambition/Brilliant

Sedia/Chair/Стул/椅子
BZ 901-332 LEATHER BUTTER



Lucidatura/Finishing/Отделка/饰面
50. IVORY

Parti in metallo/Metal parts/Металлическая фурнитура/金属部件
GOLD

Struttura in legno massello. Gambe frontali in legno di faggio con decorazioni in ottone. Parte interna ricamata; schienale con decorazione a corsetto. Imbottitura in poliuretano a quote differenziate.

Solid wood frame. Beechwood front legs with brass decoration. Quilted inner body; outer body with corset decoration. Multiple densities polyurethane foam padding.

Рама из массива дерева. Передние ножки из бука с латунной отделкой. Стеганая внутренняя часть каркаса; отделка «корсет» внешнего каркаса. Набивка из пенополиуретана разной плотности.

实木框架。山毛榉质地前腿点缀黄铜装饰内里衍缝装饰，外部交叉系带装饰。内部填充多种密度的聚氨酯泡沫垫料。

OPHELIA

DINING ARMCHAIR



As picture: Ophelia dining armchair
In price list: Ambition

Sedia/Chair/Стул/椅子
BZ 905-5141 LEATHER DARK GREY



Lucidatura/Finishing/Отделка/饰面
86. BLACK MATT

Parti in metallo/Metal parts/Металлическая фурнитура/金属部件
CROMO

DINING CHAIRS

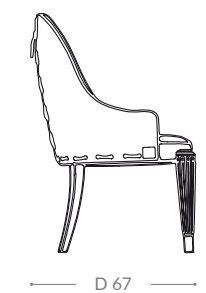
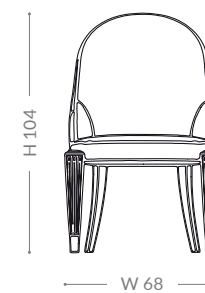

OPHELIA

DINING CHAIR

DINING CHAIRS



As picture: Ophelia dining chair
In price list: Ambition

Sedia/Chair/Стул/椅子
BZ 905-5141 LEATHER DARK GREY



Lucidatura/Finishing/Отделка/饰面
86. BLACK MATT

Parti in metallo/Metal parts/Металлическая фурнитура/金属部件
CROMO

Struttura in legno massello. Gambe frontali in legno di faggio con decorazioni in ottone. Parte interna ricamata; schienale con decorazione a corsetto. Imbottitura in poliuretano a quote differenziate.

Solid wood frame. Beechwood front legs with brass decoration. Quilted inner body; outer body with corset decoration. Multiple densities polyurethane foam padding.

Рама из массива дерева. Передние ножки из бука с латунной отделкой. Стеганая внутренняя часть каркаса; отделка «корсет» внешнего каркаса. Набивка из пенополиуретана разной плотности.

实木框架。山毛榉质地前腿点缀黄铜装饰内里褶皱装饰，外部交叉系带装饰。内部填充多种密度的聚氨酯泡沫垫料。

OPHELIA

DINING CHAIR



As picture: Ophelia dining chair
In price list: Ambition/Brilliant

Sedia/Chair/Стул/椅子
BZ 901-335 LEATHER RED



Lucidatura/Finishing/Отделка/饰面
57. CHOCOLATE

Parti in metallo/Metal parts/Металлическая фурнитура/金属部件
GOLD

DINING CHAIRS

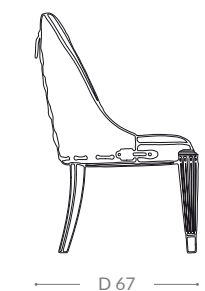
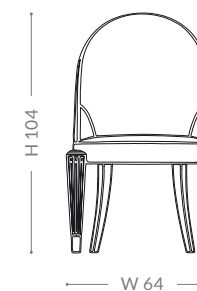

OPIUM

DINING ARMCHAIR

DINING CHAIRS



As picture: Opium dining armchair
In price list: Ambition/Brilliant

Sedia/Chair/Стул/椅子
BZ 901-622 LEATHER BEIGE

Lucidatura/Finishing/Отделка/饰面
57. CHOCOLATE
65. MAKASSAR

Parti in metallo/Metal parts/Металлическая фурнитура/金属部件
GOLD

Struttura in legno massello e multistrati di legno. Inserto ricamato su schiena e seduta. Imbottiture in poliuretano a quote differenziate. Disponibile in essenza di ebano makassar.

Solid wood and plywood frame. Quilted backrest and seating. Multiple densities polyurethane foam padding. Available in makassar ebony veneer.

Рама из массива дерева и фанеры. Стеганая спинка и сиденье. Набивка из пенополиуретана разной плотности. Доступный материал: шпон макассарского эбена.

实木和胶合板框架。座椅面和靠背衍缝装饰。内部填充多种密度的聚氨酯泡沫垫料。孟加锡乌木饰板面。

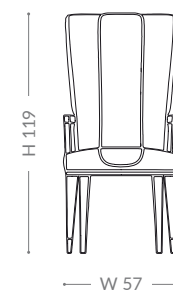

OPIUM

DINING CHAIR

DINING CHAIRS



As picture: Opium dining chair
In price list: Ambition/Brilliant

Sedia/Chair/Стул/椅子
BZ 901-622 LEATHER BEIGE

Lucidatura/Finishing/Отделка/饰面
57. CHOCOLATE
65. MAKASSAR

Parti in metallo/Metal parts/Металлическая фурнитура/金属部件
GOLD

Struttura in legno massello e multistrati di legno. Inserto ricamato su schiena e seduta. Imbottiture in poliuretano a quote differenziate. Disponibile in essenza di ebano makassar.

Solid wood and plywood frame. Quilted backrest and seating. Multiple densities polyurethane foam padding. Available in makassar ebony veneer.

Рама из массива дерева и фанеры. Стеганая спинка и сиденье. Набивка из пенополиуретана разной плотности. Доступный материал: шпон макассарского эбена.

实木和胶合板框架。座椅面和靠背衍缝装饰。内部填充多种密度的聚氨酯泡沫垫料。孟加锡乌木饰板面。

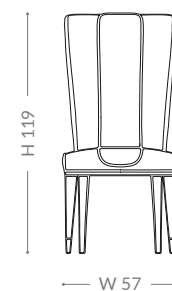

SUNRISE

DINING ARMCHAIR

DINING CHAIRS



As picture: Sunrise dining armchair
In price list: Ambition

Sedia/Chair/Стул/椅子
BZ 906-2005 LEATHER OASI

Lucidatura/Finishing/Отделка/饰面
70. CANALETTO WALNUT MATT
85. CHOCOLATE MATT

Struttura in legno massello. Gambe frontali in noce canaletto. Schienale e seduta decorata con ricamo. Imbottitura in poliuretano a quote differenziate.

Solid wood frame. Canaletto walnut wooden front legs. Quilted backrest and seating. Multiple densities polyurethane foam padding.

Рама из массива дерева. Деревянные передние ножки цвета ореха каналетто. Стеганая спинка и сиденье. Набивка из пенополиуретана разной плотности.

实木框架。前腿为卡纳莱托胡桃木。座椅面和靠背衍缝装饰。内部填充多种密度的聚氨酯泡沫垫料。

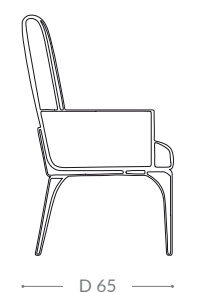
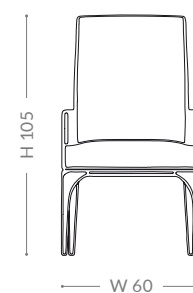

SUNRISE

DINING CHAIR



DINING CHAIRS

As picture: Sunrise dining chair
In price list: Ambition

Sedia/Chair/Стул/椅子
BZ 906-2005 LEATHER OASI

Lucidatura/Finishing/Отделка/饰面
70. CANALETTO WALNUT MATT
85. CHOCOLATE MATT

Struttura in legno massello. Gambe frontali in noce canaletto. Schienale e seduta decorata con ricamo. Imbottitura in poliuretano a quote differenziate.

Solid wood frame. Canaletto walnut wooden front legs. Quilted backrest and seating. Multiple densities polyurethane foam padding.

Рама из массива дерева. Деревянные передние ножки цвета ореха каналетто. Стеганая спинка и сиденье. Набивка из пенополиуретана разной плотности.

实木框架。前腿为卡纳莱托胡桃木。座椅面和靠背衍缝装饰。内部填充多种密度的聚氨酯泡沫垫料。

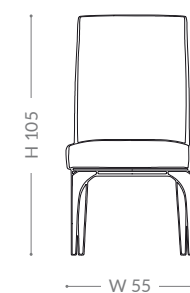

VERSAILLE

DINING ARMCHAIR

DINING CHAIRS



As picture: Versailles dining armchair
In price list: Prestige/Brilliant

Sedia/Chair/Стул/椅子
BZ 906-2006 LEATHER TAUPE
BZ 215-05 JACQUARD SANDSTONE

Lucidatura/Finishing/Отделка/饰面
54. GREY

Struttura in legno massello.
Parte esterna in pelle ricamata.
Imbottiture in poliuretano a
quote differenziate.

Solid wood frame. Quilted
leather outer body. Multiple
densities polyurethane foam
padding.

Рама из массива дерева.
Внешняя часть каркаса из
стеганой кожи. Набивка из
пенополиуретана разной
плотности.

实木框架。外部为衿缝皮革。
内部填充多种密度的聚氨酯泡
沫垫料。

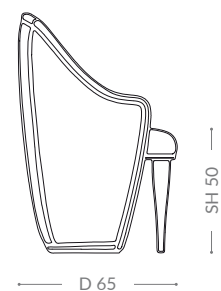
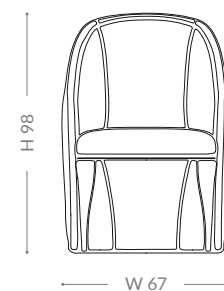

VERSAILLE

DINING CHAIR



DINING CHAIRS

As picture: Versailles dining chair
In price list: Prestige/Brilliant

Sedia/Chair/Стул/椅子
BZ 906-2006 LEATHER TAUPE
BZ 215-05 JACQUARD SANDSTONE

Lucidatura/Finishing/Отделка/饰面
54. GREY

Struttura in legno massello.
Parte esterna in pelle ricamata.
Imbottiture in poliuretano a
quote differenziate.

Solid wood frame. Quilted
leather outer body. Multiple
densities polyurethane foam
padding.

Рама из массива дерева.
Внешняя часть каркаса из
стеганой кожи. Набивка из
пенополиуретана разной
плотности.

实木框架。外部为衿缝皮革。
内部填充多种密度的聚氨酯泡
沫垫料。

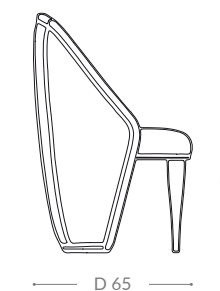
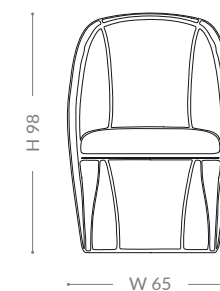

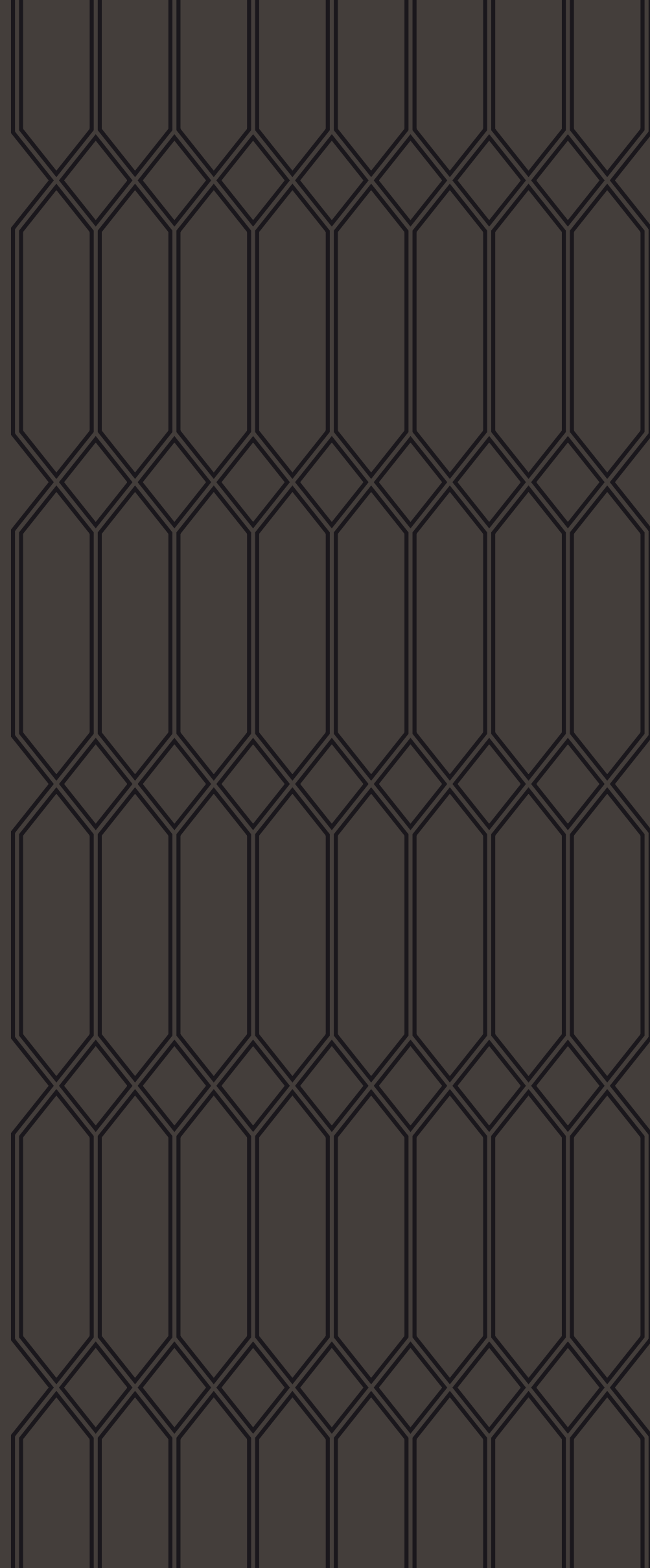

ZB

BAR COUNTERS
AND STOOLS



DIONISO

BAR COUNTER



Struttura in multistrati di legno e MDF. Decorazione frontale con profili di metallo e specchio. Illuminazione LED.

Plywood and MDF wooden frame. Mirror and metal vertical rods. LED lighting.

Деревянная рама из МДФ и фанеры. Зеркальные и металлические вертикальные панели. Светодиодное освещение.

胶合板和中密度纤维板木制框架。镜面和金属纵向装饰柱。LED 照明。

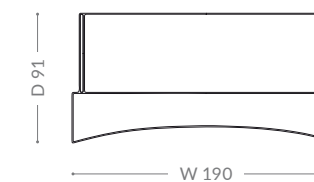
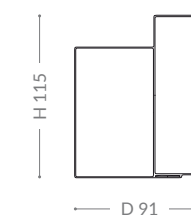
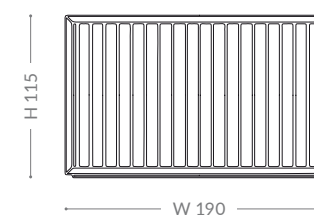

BAR COUNTERS

As picture: **Dioniso bar counter**
In price list: Prime

Lucidatura/Finishing/Отделка/饰面
86. BLACK MATT

Parti in metallo/Metal parts/Металлическая фурнитура/金属部件
TITANIUM

Decorazione/Decoration/Декоративный элемент/装饰
MIRROR EXTRA WHITE

LEGEND

BAR COUNTER

Struttura in multistrati di legno e MDF. Piano in marmo. Decorazione frontale in pelle ricamata. Colonne decorative in legno e metallo. Illuminazione LED.

Plywood and MDF wooden frame. Marble top. Frontal leather quilted decoration. Metal and wooden decorative columns. LED lighting.

Деревянная рама из МДФ и фанеры. Мраморная столешница. Передняя отделка из стеганой кожи. Металлические и деревянные декоративные колонны. Светодиодное освещение.

胶合板和中密度纤维板木制框架。大理石台面。正面点缀绗缝装饰。金属和实木装饰柱。LED 照明。



BAR COUNTERS

As picture: Legend bar counter
In price list: Brilliant/Precious stone

Lucidatura/Finishing/Отделка/饰面
57. CHOCOLATE

Parti in metallo/Metal parts/Металлическая фурнитура/金属部件
GOLD

Marmo/Marble/Мрамор/大理石
EMPERADOR LIGHT
Materiale/Material/Материал/材料
BZ 904-4632 LEATHER SAND

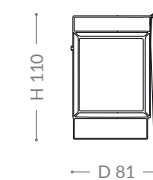
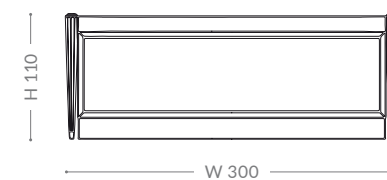

ARISTON

BAR STOOL

STOOLS



As picture: Ariston bar stool
In price list: Ambition

Sgabello bar/Bar stool/Барный стул/吧椅
BZ 905-5234 LEATHER BEIGE

Parti in metallo/Metal parts/Металлическая фурнитура/金属部件
GOLD

Struttura in metallo; seduta e schienale in legno con imbottitura in poliuretano a quote differenziate. Parte esterna decorata con ricamo.

Metal frame; wooden backrest and seating, with multiple densities polyurethane foam padding. Quilted outer body.

Металлическая рама; деревянная спинка и сиденье с набивкой из пенополиуретана разной плотности. Стеганая внешняя часть корпуса.

金属框架; 木质靠背和座位, 内部填充多种密度的聚氨酯泡沫垫料。外侧部分绗缝。

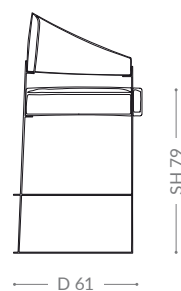

FLOWER

BAR STOOL

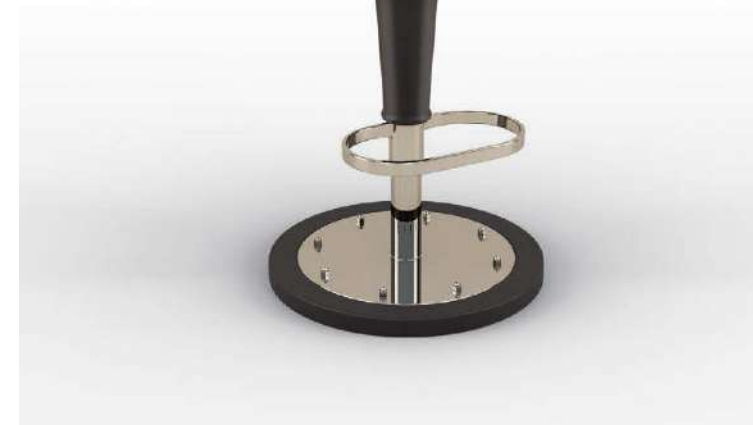

STOOLS

As picture: Flower bar stool
In price list: Ambition

Sgabello bar/Bar stool/Барный стул/吧椅
BZ 905-5141 LEATHER DARK GREY

Lucidatura/Finishing/Отделка/饰面
86. BLACK MATT

Parti in metallo/Metal parts/Металлическая фурнитура/金属部件
TITANIUM

Struttura in legno massello. Base centrale in metallo e legno di faggio. Seduta e schienale con decorazione a fasce trapuntate. Imbottitura in poliuretano a quote differenziate.

Solid wood frame. Metal and beechwood central base. Seating and backrest decorated with vertical piping. Multiple densities polyurethane foam padding.

Рама из массива дерева. Основа из металла и бука. Сиденье и спинка украшены вертикальной окантовкой. Набивка из пенополиуретана разной плотности.

实木框架。金属和山毛榉中央底座。座位和靠背点缀纵向滚边。内部填充多种密度的聚氨酯泡沫垫料。

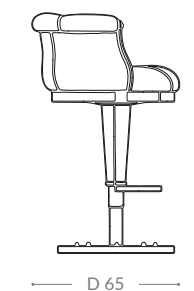
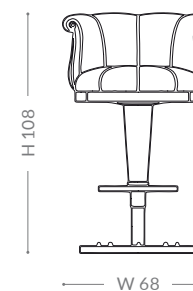

OPHELIA

BAR STOOL

S
T
O
O
L
S



As picture: Ophelia bar stool
In price list: Ambition/
Brilliant

Sgabello bar/Bar stool/Барный
стул/吧椅
BZ 904-4632 LEATHER SAND



Lucidatura/Finishing/Отделка/饰面
57. CHOCOLATE

Parti in metallo/Metal parts/Метал-
лическая фурнитура/金属部件
GOLD

Struttura in legno massello.
Base centrale in metallo
e legno di faggio con
decorazioni in ottone. Parte
interna ricamata; schienale
con decorazione a corsetto.
Imbottitura in poliuretano a
quote differenziate.

Solid wood frame. Metal and
beechwood central base with
brass decoration. Quilted
inner body; outer body corset
decoration. Multiple densities
polyurethane foam padding.

Рама из массива дерева.
Основа из металла и бука
с латунной отделкой.
Стеганая внутренняя часть
каркаса; отделка «корсет»
внешнего каркаса. Набивка
из пенополиуретана разной
плотности.

实木框架。金属和山毛榉中央
底座，饰以黄铜装饰。内里褶
缝装饰，外部交叉系带装饰。
内部填充多种密度的聚氨酯泡
沫垫料。

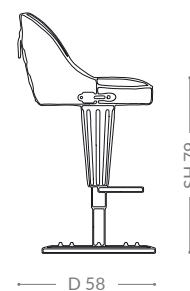
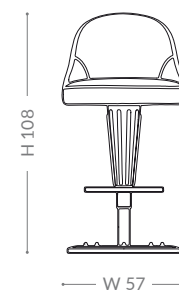

OPHELIA

BAR TABLE

B
A
R
T
A
B
L
E



As picture: Ophelia bar table
In price list: Brilliant

Lucidatura/Finishing/Отделка/饰面
57. CHOCOLATE
65. MAKASSAR

Parti in metallo/Metal parts/Метал-
лическая фурнитура/金属部件
GOLD



Struttura in metallo e legno
con decorazioni in ottone.
Piano disponibile in legno
laccato, noce canaletto e
ebano makassar.

Metal and wood frame with
brass decoration. Top available
in lacquered wood, canaletto
walnut or makassar ebony.

Рама из металла и древесины с
латунной отделкой. Доступно
сиденье из следующих
материалов: лакированная
древесина, орех каналетто или
макассарский эбен.

金属和实木框架，饰以黄铜装
饰。台面质地可选漆木、卡纳
莱托核桃木或孟加锡乌木。

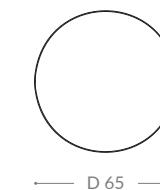
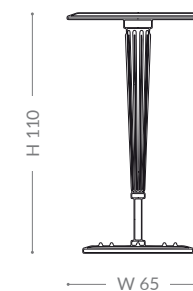

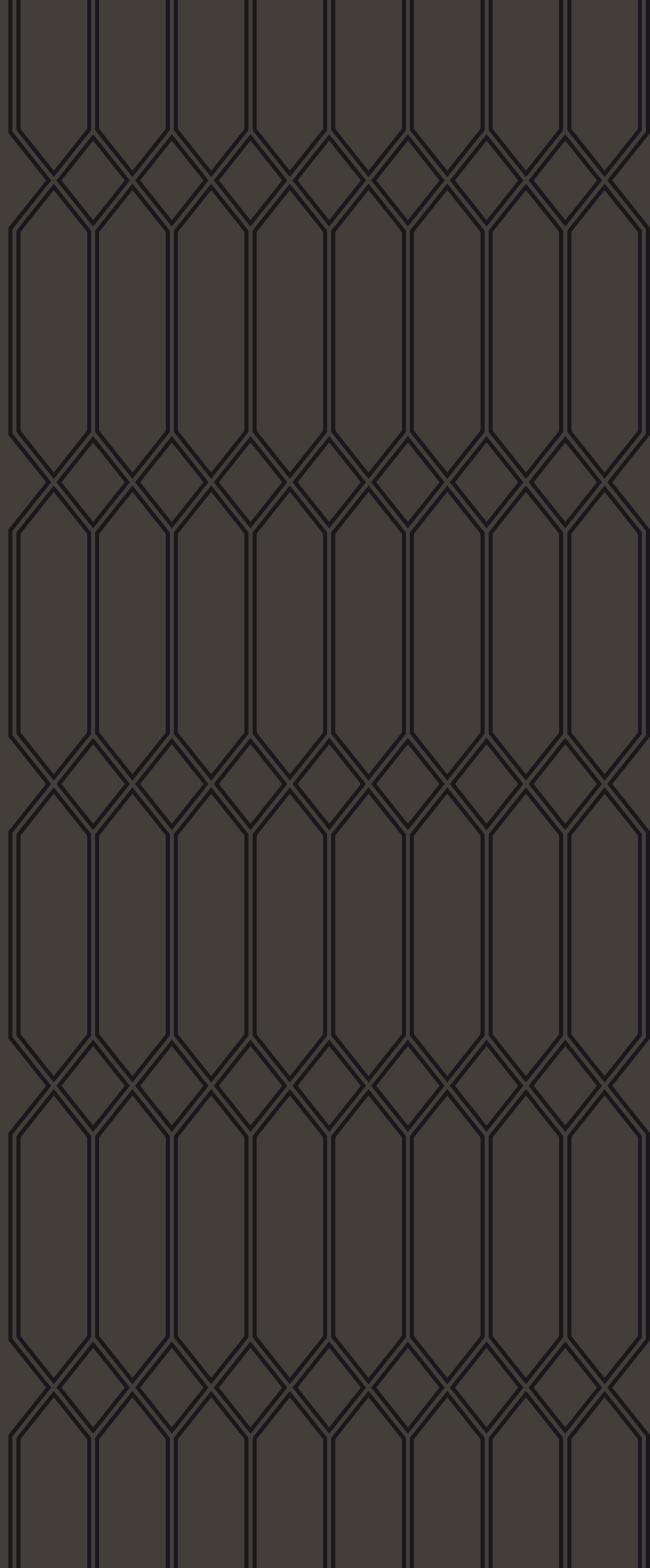

ZB

SUMMARY



SOFAS



AMAZON SOFA
Vol. 1 - pag. 22



AMBASSADOR SOFA
Vol. 1 - pag. 24



AMBASSADOR MODULAR SOFA
Vol. 1 - pag. 26



BABYLON SOFA
Vol. 1 - pag. 30



GATSBY SOFA
Vol. 1 - pag. 56



GIASONE SOFA
Vol. 1 - pag. 58



GIASONE MODULAR SOFA
Vol. 1 - pag. 61



GORDON SOFA
Vol. 1 - pag. 64



BARRYMORE SOFA
Vol. 1 - pag. 32



BARRYMORE MODULAR SOFA
Vol. 1 - pag. 34



BAUHAUS SOFA
Vol. 1 - pag. 36



BAUHAUS SOFA
Vol. 1 - pag. 38



GORDON MODULAR SOFA
Vol. 1 - pag. 67



HARMONY SOFA
Vol. 1 - pag. 70



HEMINGWAY SOFA
Vol. 1 - pag. 72



IPAZIA SOFA
Vol. 1 - pag. 74



CLUB SOFA
Vol. 1 - pag. 40



COCÒ SOFA
Vol. 1 - pag. 42



DAVIS SOFA
Vol. 1 - pag. 44



DAVIS MODULAR SOFA
Vol. 1 - pag. 46



KING SOFA
Vol. 1 - pag. 76



LEGEND SOFA
Vol. 1 - pag. 78



LEGEND SOFA
Vol. 1 - pag. 80



POSEIDON SOFA
Vol. 1 - pag. 82



EMPERADOR SOFA
Vol. 1 - pag. 48



EMPERADOR SOFA
Vol. 1 - pag. 50



FLY SOFA
Vol. 1 - pag. 52



GATSBY SOFA
Vol. 1 - pag. 54



POSEIDON SOFA
Vol. 1 - pag. 84



VERTIGO SOFA
Vol. 1 - pag. 86



VERTIGO SOFA
Vol. 1 - pag. 88



WAVE SOFA
Vol. 1 - pag. 90



WAVE MODULAR SOFA
Vol. 1 - pag. 93



CLUB WIDE ARMCHAIR
Vol. 1 - pag. 114



DAVIS ARMCHAIR
Vol. 1 - pag. 116



DAVIS SMALL ARMCHAIR
Vol. 1 - pag. 118



FLOWER ARMCHAIR
Vol. 1 - pag. 120

ARMCHAIRS



FLY ARMCHAIR
Vol. 1 - pag. 122



IPAZIA ARMCHAIR
Vol. 1 - pag. 124



IPAZIA ARMCHAIR
Vol. 1 - pag. 126



KING ARMCHAIR
Vol. 1 - pag. 128



ARDEA ARMCHAIR
Vol. 1 - pag. 98



ARDEA ARMCHAIR
Vol. 1 - pag. 100



ARIEL ARMCHAIR
Vol. 1 - pag. 102



AURORA ARMCHAIR
Vol. 1 - pag. 104



LEGEND ARMCHAIR
Vol. 1 - pag. 130



LEGEND ARMCHAIR
Vol. 1 - pag. 132



LOPEZ ARMCHAIR
Vol. 1 - pag. 134



MARYLOU ARMCHAIR
Vol. 1 - pag. 136



BAUHAUS ARMCHAIR
Vol. 1 - pag. 106



BEVERLY ARMCHAIR
Vol. 1 - pag. 108



BEVERLY ARMCHAIR
Vol. 1 - pag. 110



CLUB ARMCHAIR
Vol. 1 - pag. 112



MARYLOU ARMCHAIR
Vol. 1 - pag. 138



PANDORA ARMCHAIR
Vol. 1 - pag. 140



PANDORA ARMCHAIR
Vol. 1 - pag. 142



WALLY ARMCHAIR
Vol. 1 - pag. 144

DORMEUSE



COLETTE DORMEUSE
Vol. 1 - pag. 148



GERRIT DORMEUSE
Vol. 1 - pag. 150



GORDON DORMEUSE
Vol. 1 - pag. 152



LEGEND DORMEUSE
Vol. 1 - pag. 154

POUFS



ADAM POUF
Vol. 1 - pag. 158



BELLE POUF
Vol. 1 - pag. 159



FLY POUF
Vol. 1 - pag. 160



FLY CAPITONNÉ POUF
Vol. 1 - pag. 161



KIMBERLY POUF
Vol. 1 - pag. 162



MOON WALT POUF
Vol. 1 - pag. 163

SOFA TABLES



ALCESTE SIDE TABLE
Vol. 1 - pag. 166



CLUB CENTRAL TABLE
Vol. 1 - pag. 167



CLUB SIDE TABLE
Vol. 1 - pag. 168



DEA SIDE TABLE
Vol. 1 - pag. 169



DEA TWIN SET
Vol. 1 - pag. 170



ESEDRA SIDE TABLE
Vol. 1 - pag. 171



ESEDRA CENTRAL TABLE SET
Vol. 1 - pag. 172



EXPERIA CENTRAL TABLE
Vol. 1 - pag. 173



FLY CENTRAL TABLE
Vol. 1 - pag. 174



FLY SIDE TABLE
Vol. 1 - pag. 175



GREY TABLE SET
Vol. 1 - pag. 176



HECTOR SIDE TABLE
Vol. 1 - pag. 177



MUMFORD CENTRAL TABLE
Vol. 1 - pag. 178



MUMFORD SIDE TABLE
Vol. 1 - pag. 179



NEW LINE RECTANGULAR CENTRAL TABLE
Vol. 1 - pag. 180



NEW LINE SQUARE CENTRAL TABLE
Vol. 1 - pag. 181



NEW LINE SIDE TABLE
Vol. 1 - pag. 182



NEW LINE SIDE TABLE
Vol. 1 - pag. 183



OLIVER CENTRAL TABLE
Vol. 1 - pag. 184



OLIVER SIDE TABLE
Vol. 1 - pag. 185



TRITON ROUND TABLE 45
Vol. 1 - pag. 199



TRITON ROUND TABLE 60
Vol. 1 - pag. 200



TRITON COURTESY TABLE
Vol. 1 - pag. 201



TULIP ROUND TABLE
Vol. 1 - pag. 202



OLIVER COURTESY TABLE
Vol. 1 - pag. 186



OTTO CENTRAL TABLE
Vol. 1 - pag. 187



OTTO CENTRAL TABLE
Vol. 1 - pag. 188



RUPERT CENTRAL TABLE
Vol. 1 - pag. 189



TULIP SIDE TABLE 35+45
Vol. 1 - pag. 203



TULIP TRIS SET
Vol. 1 - pag. 204



WAVE CENTRAL TABLE
Vol. 1 - pag. 205



RUPERT CENTRAL TABLE
Vol. 1 - pag. 190



RUPERT ROUND TABLE
Vol. 1 - pag. 191



RUPERT ROUND TABLE
Vol. 1 - pag. 192



STAN CENTRAL TABLE
Vol. 1 - pag. 193



STAN COURTESY TABLE
Vol. 1 - pag. 194



STAN SIDE TABLE
Vol. 1 - pag. 195



TRITON CENTRAL TABLE
Vol. 1 - pag. 196



TRITON SQUARE TABLE
Vol. 1 - pag. 198

DINING TABLES



BOSTON RECTANGULAR DINING TABLE
Vol. 1 - pag. 208



BOSTONWIDE RECTANGULAR DINING TABLE
Vol. 1 - pag. 210



BOSTON ROUND DINING TABLE
Vol. 1 - pag. 212



GILLON EXTENSIBLE DINING TABLE
Vol. 1 - pag. 214



PETRUS RECTANGULAR DINING TABLE
Vol. 1 - pag. 240



PETRUS ROUND DINING TABLE
Vol. 1 - pag. 242



PETRUS ROUND DINING TABLE
Vol. 1 - pag. 244



WANDA RECTANGULAR DINING TABLE
Vol. 1 - pag. 246



MANHATTAN RECTANGULAR DINING TABLE
Vol. 1 - pag. 216



METROPOLIS ELLIPTICAL DINING TABLE
Vol. 1 - pag. 218



METROPOLISWIDE ELLIPTICAL DINING TABLE
Vol. 1 - pag. 220



METROPOLIS ROUND DINING TABLE
Vol. 1 - pag. 222

DINING CHAIRS



MILLENIUM ROUND DINING TABLE
Vol. 1 - pag. 224



MILLENIUM RECTANGULAR DINING TABLE
Vol. 1 - pag. 226



OMEGA CRYSTAL RECTANGULAR DINING TABLE
Vol. 1 - pag. 228



OMEGA EBONY RECTANGULAR DINING TABLE
Vol. 1 - pag. 230



ARISTON DINING CHAIR
Vol. 1 - pag. 250



ARISTON DINING CHAIR
Vol. 1 - pag. 251



CAPRICE DINING ARMCHAIR
Vol. 1 - pag. 252



CAPRICE DINING CHAIR
Vol. 1 - pag. 253



OMEGA CRYSTAL ROUND DINING TABLE
Vol. 1 - pag. 232



OMEGA EBONY ROUND DINING TABLE
Vol. 1 - pag. 234



ORION ROUND DINING TABLE
Vol. 1 - pag. 236



ORION RECTANGULAR DINING TABLE
Vol. 1 - pag. 238



CELINE DINING ARMCHAIR
Vol. 1 - pag. 254



CELINE DINING CHAIR
Vol. 1 - pag. 255



DILETTA DINING ARMCHAIR
Vol. 1 - pag. 256



DILETTA DINING ARMCHAIR
Vol. 1 - pag. 257

BAR COUNTERS AND STOOLS



DILETTA DINING CHAIR
Vol. 1 - pag. 258



DILETTA DINING CHAIR
Vol. 1 - pag. 259



GRETA DINING ARMCHAIR
Vol. 1 - pag. 260



GRETA DINING CHAIR
Vol. 1 - pag. 261



DIONISO BAR COUNTER
Vol. 1 - pag. 276



LEGEND BAR COUNTER
Vol. 1 - pag. 278



ARISTON BAR STOOL
Vol. 1 - pag. 280



FLOWER BAR STOOL
Vol. 1 - pag. 281



MARYBELL DINING ARMCHAIR
Vol. 1 - pag. 262



MARYBELL DINING ARMCHAIR
Vol. 1 - pag. 263



OPHELIA DINING ARMCHAIR
Vol. 1 - pag. 264



OPHELIA DINING ARMCHAIR
Vol. 1 - pag. 265



OPHELIA BAR STOOL
Vol. 1 - pag. 282



OPHELIA BAR TABLE
Vol. 1 - pag. 283



OPHELIA DINING CHAIR
Vol. 1 - pag. 266



OPHELIA DINING CHAIR
Vol. 1 - pag. 267



OPIUM DINING ARMCHAIR
Vol. 1 - pag. 268



OPIUM DINING CHAIR
Vol. 1 - pag. 269



SUNRISE DINING ARMCHAIR
Vol. 1 - pag. 270



SUNRISE DINING CHAIR
Vol. 1 - pag. 271



VERSAILLE DINING ARMCHAIR
Vol. 1 - pag. 272



VERSAILLE DINING CHAIR
Vol. 1 - pag. 273

BEDS



APOLLO BED
Vol. 2 - pag. 22



BERNINI BED
Vol. 2 - pag. 24



BERNINI WIDE BED
Vol. 2 - pag. 26



BERNINI XYLO BED
Vol. 2 - pag. 28



BERNINI XYLO WIDE BED
Vol. 2 - pag. 30



CLEO BED
Vol. 2 - pag. 32



HERMES BED
Vol. 2 - pag. 34



HERMITAGE BED
Vol. 2 - pag. 36



HORIZON BED
Vol. 2 - pag. 38



JUNO BED
Vol. 2 - pag. 40



KING BED
Vol. 2 - pag. 42



MADISON BED
Vol. 2 - pag. 44



OCEAN BED
Vol. 2 - pag. 46



OVERWALL BED
Vol. 2 - pag. 48

BEDSIDE TABLES



BUSTER BEDSIDE TABLE
Vol. 2 - pag. 52



CLARK BEDSIDE TABLE
Vol. 2 - pag. 53



ELYPSE BEDSIDE TABLE
Vol. 2 - pag. 54



ELYPSE BEDSIDE TABLE
Vol. 2 - pag. 55



GLENN BEDSIDE TABLE
Vol. 2 - pag. 56



HERMES BEDSIDE TABLE
Vol. 2 - pag. 57



HORIZON BEDSIDE TABLE
Vol. 2 - pag. 58



OCEAN I BEDSIDE TABLE
Vol. 2 - pag. 59



OCEAN II BEDSIDE TABLE
Vol. 2 - pag. 60



REMINGTON BEDSIDE TABLE
Vol. 2 - pag. 61



STUART BEDSIDE TABLE
Vol. 2 - pag. 62



STUART BEDSIDE TABLE
Vol. 2 - pag. 63

CHEST OF DRAWERS



BUSTER CHEST OF DRAWERS
Vol. 2 - pag. 66



BUSTER CHEST OF DRAWERS
Vol. 2 - pag. 68



DEANNA CHEST OF DRAWERS
Vol. 2 - pag. 70



GLENN CHEST OF DRAWERS
Vol. 2 - pag. 72



REMINGTON CHEST OF DRAWERS
Vol. 2 - pag. 74

DRESSING TABLES



EMANUELLE DRESSING TABLE
Vol. 2 - pag. 78



KIMBERLY DRESSING TABLE
Vol. 2 - pag. 80



KIMBERLY POUF
Vol. 2 - pag. 81



MADEMOISELLE DRESSING TABLE
Vol. 2 - pag. 82



MADEMOISELLE CHAIR
Vol. 2 - pag. 84



VIVIEN DRESSING TABLE
Vol. 2 - pag. 86



MOON WALT POUF
Vol. 2 - pag. 87

BENCHES



ADAM BENCH
Vol. 2 - pag. 90



BLANGA BENCH 100
Vol. 2 - pag. 91



BLANGA BENCH 160
Vol. 2 - pag. 92



FAYR BENCH
Vol. 2 - pag. 93



FLY BENCH
Vol. 2 - pag. 94



GREY BENCH
Vol. 2 - pag. 95



HERMES BENCH
Vol. 2 - pag. 96



MOON WALT BENCH
Vol. 2 - pag. 97

CONSOLES



KIMBERLY CONSOLLE
Vol. 2 - pag. 100



KIMBERLY CONSOLLE SMALL
Vol. 2 - pag. 102



LUCINDA CONSOLLE
Vol. 2 - pag. 104



LUCINDA CONSOLLE
Vol. 2 - pag. 106



RANDOLPH CONSOLLE
Vol. 2 - pag. 108



SWING BACKSOFA CONSOLLE
Vol. 2 - pag. 110



SWING CONSOLLE LARGE
Vol. 2 - pag. 112



SWING CONSOLLE SMALL
Vol. 2 - pag. 114



WANDA CONSOLLE
Vol. 2 - pag. 116



WANDA CONSOLLE SMALL
Vol. 2 - pag. 118

SIDEBOARDS



CONCORDE SIDEBOARD
Vol. 2 - pag. 122



CONCORDE SIDEBOARD WIDE
Vol. 2 - pag. 124



DEANNA SIDEBOARD 9 DRAWERS
Vol. 2 - pag. 126



DEANNA SIDEBOARD 3 DRAWERS
Vol. 2 - pag. 128



DUKE SIDEBOARD
Vol. 2 - pag. 130



FIORILE SIDEBOARD
Vol. 2 - pag. 132



GLENN SIDEBOARD HIGH
Vol. 2 - pag. 134



GLENN SIDEBOARD LOW
Vol. 2 - pag. 136



REMINGTON SIDEBOARD
Vol. 2 - pag. 138

TV UNITS



CONCORDE TV FRAME
Vol. 2 - pag. 142



CONCORDE TV CABINET
Vol. 2 - pag. 144



DUCA TV FRAME
Vol. 2 - pag. 146



DUCA TV CABINET
Vol. 2 - pag. 148



DUKE TV FRAME
Vol. 2 - pag. 150

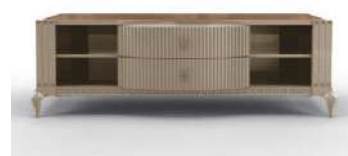

DUKE TV CABINET
Vol. 2 - pag. 152



FIORILE TV CABINET
Vol. 2 - pag. 154



REMINGTON TV FRAME
Vol. 2 - pag. 156



REMINGTON TV CABINET
Vol. 2 - pag. 158

DISPLAY CABINETS



CONCORDE DISPLAY CABINET
Vol. 2 - pag. 162



ESTELLE DISPLAY CABINET
Vol. 2 - pag. 164



ESTELLE DISPLAY CABINET
Vol. 2 - pag. 166



FRITZ DISPLAY CABINET
Vol. 2 - pag. 168



KIMBERLY DISPLAY CABINET
Vol. 2 - pag. 170



VENUS DISPLAY CABINET
Vol. 2 - pag. 172

BOOKSHELVES



CLARK BOOKSHELF
Vol. 2 - pag. 176



DAFNE BOOKSHELF
Vol. 2 - pag. 178



JADE BOOKSHELF
Vol. 2 - pag. 180



SIRIO BOOKSHELF
Vol. 2 - pag. 182

CABINETS



CONCORDE WARDROBE CABINET
Vol. 2 - pag. 186



CONCORDE WINE CABINET
Vol. 2 - pag. 188



DEDALO BACK SOFA CABINET
Vol. 2 - pag. 191



DEDALO CABINET
Vol. 2 - pag. 192



RICHELIEU BAR CABINET
Vol. 2 - pag. 206



RICHELIEU GAMING CABINET
Vol. 2 - pag. 208



VENUS CABINET
Vol. 2 - pag. 210



DEDALO DUAL UNIT
Vol. 2 - pag. 193



DEDALO FREE STANDING PARTITION 1
Vol. 2 - pag. 194



DEDALO FREE STANDING PARTITION 2
Vol. 2 - pag. 195



DEDALO LIBRARY
Vol. 2 - pag. 196

DESKS



DEDALO OFFICE COMPOSITION
Vol. 2 - pag. 197



DEDALO SIDEBOARD
Vol. 2 - pag. 198



DEDALO TV CABINET 1
Vol. 2 - pag. 199



DEDALO TV COMPOSITION 1
Vol. 2 - pag. 200



ASTORIA DESK
Vol. 2 - pag. 214



CLARK DESK
Vol. 2 - pag. 216



LEGEND DESK
Vol. 2 - pag. 218



SQUARE DESK
Vol. 2 - pag. 220



DEDALO TV COMPOSITION 2
Vol. 2 - pag. 201

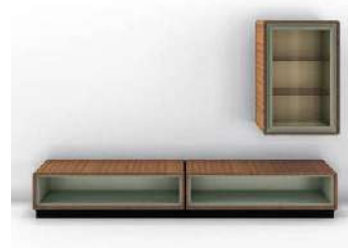

DEDALO TV COMPOSITION 3
Vol. 2 - pag. 202



DEDALO WALL COMPOSITION
Vol. 2 - pag. 203



FRITZ BAR CABINET
Vol. 2 - pag. 204

OFFICE CHAIRS



ATLANTIS OFFICE CHAIR
Vol. 2 - pag. 224



COMET FRONT DESK CHAIR
Vol. 2 - pag. 225



COMET OFFICE CHAIR
Vol. 2 - pag. 226



LONDON OFFICE CHAIR
Vol. 2 - pag. 227



REGENT FRONT DESK CHAIR
Vol. 2 - pag. 228



REGENT OFFICE CHAIR
Vol. 2 - pag. 229

MIRRORS

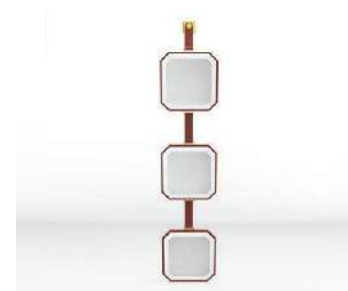

ARTEMIDE MIRROR
Vol. 2 - pag. 232



CONSTANCE MIRROR
Vol. 2 - pag. 233



ETIENNE MIRROR
Vol. 2 - pag. 234

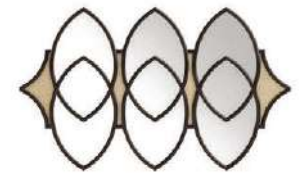

FLYNN MIRROR
Vol. 2 - pag. 235



IKE MIRROR
Vol. 2 - pag. 236



JUPITER MIRROR
Vol. 2 - pag. 237



OSIRIS RECTANGULAR MIRROR
Vol. 2 - pag. 238



OSIRIS ROUND MIRROR
Vol. 2 - pag. 239



SHIRLEY MIRROR
Vol. 2 - pag. 240



TWIN MIRROR
Vol. 2 - pag. 241

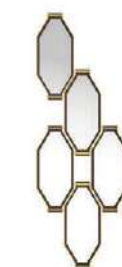

TWIN MIRRORS COMPOSITION 1
Vol. 2 - pag. 242



TWIN MIRRORS COMPOSITION 2
Vol. 2 - pag. 243

DECORATIONS



ARES PANELING
Vol. 2 - pag. 246



BAUHAUS COLUMN
Vol. 2 - pag. 248



CLUB COLUMN
Vol. 2 - pag. 249



EOLO SAIL
Vol. 2 - pag. 250



LEONE WOOD SCREEN
Vol. 2 - pag. 252



ODISSEY SCREEN
Vol. 2 - pag. 254

RUGS



AMBASSADOR RUG
Vol. 2 - pag. 258



ASTORIA RUG
Vol. 2 - pag. 259



CLUB CARVED RUG
Vol. 2 - pag. 260



OCEAN RUG
Vol. 2 - pag. 261



PETRUS RUG
Vol. 2 - pag. 262

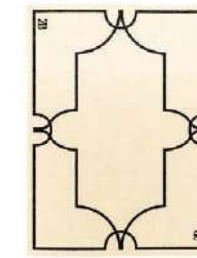

SHIRLEY RUG
Vol. 2 - pag. 263



VERTIGO RUG
Vol. 2 - pag. 264

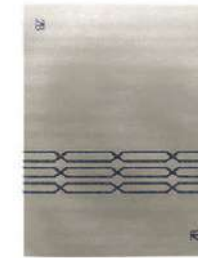

WAVE RUG
Vol. 2 - pag. 265

LIGHTINGS



ASTORIA TABLE LAMP
Vol. 2 - pag. 268



ASTORIA WALL LAMP
Vol. 2 - pag. 269



BERNINI TABLE LAMP
Vol. 2 - pag. 270



TWIN CHANDELIER
Vol. 2 - pag. 271



TWIN RECTANGULAR CHANDELIER
Vol. 2 - pag. 272



TWIN SUSPENSION LAMP
Vol. 2 - pag. 273



TWIN STANDING LAMP
Vol. 2 - pag. 274



TWIN TABLE LAMP
Vol. 2 - pag. 275



TWIN WALL LAMP
Vol. 2 - pag. 276



WAVE STANDING LAMP
Vol. 2 - pag. 277



WAVE TABLE LAMP
Vol. 2 - pag. 278

CONTACT US

BRUNO ZAMPA s.r.l.

Via Crosaron, 23
37053 Cerea
Verona - Italy
T. +39 0442 80594
F. +39 0442 329534

GALLERY

Via Calcara, 68/70
37053 Cerea
Verona - Italy

info@brunozampa.it
www.brunozampa.it

Produced by
©Bruno Zampa s.r.l. - All rights reserved

PHOTO Lighthug Design s.r.l. and Place Design e Rendering s.r.l.s.

GRAPHIC DESIGN Deepartweb s.r.l.

PRINTING Grafiche Stella s.r.l.

All products in this catalogue are 100% Made in Italy.

All colors of leather or fabric's covers, lacquered wood and rugs can't be considered as color references.

The dimensions of products are subject to change according to the instructions of the catalogue.

Any reproduction, representation or modification, in full or partly, is expressly prohibited.



www.brunozampa.it



LUXURY CRAFTED IN VERONA

THE PRODUCTS

2
VOLUME



ZB
Bruno Zampa
LUXURY CRAFTED IN VERONA

INDEX

VOL. 01

INTRODUCTION 4

SOFAS, ARMCHAIRS & COMPLEMENTS

SOFAS 20
ARMCHAIRS 96
DORMEUSE 146
POUFS 156
SOFA TABLES 164

TABLES & DINING CHAIRS

DINING TABLES 206
DINING CHAIRS 248
BAR COUNTERS AND STOOLS 274

SUMMARY 284

VOL. 02

INTRODUCTION 4

BEDS & COMPLEMENTS

BEDS 20
BEDSIDE TABLES 50
CHEST OF DRAWERS 64
DRESSING TABLES 76
BENCHES 88

CABINETS

CONSOLLES 98
SIDEBOARDS 120
TV UNITS 140
DISPLAY CABINETS 160
BOOKSHELVES 174
CABINETS 184

OFFICE

DESKS 214
OFFICE CHAIRS 222

OCCASIONALS & DECORATIONS

MIRRORS 230
DECORATIONS 244
RUGS 256
LIGHTINGS 266

SUMMARY 280

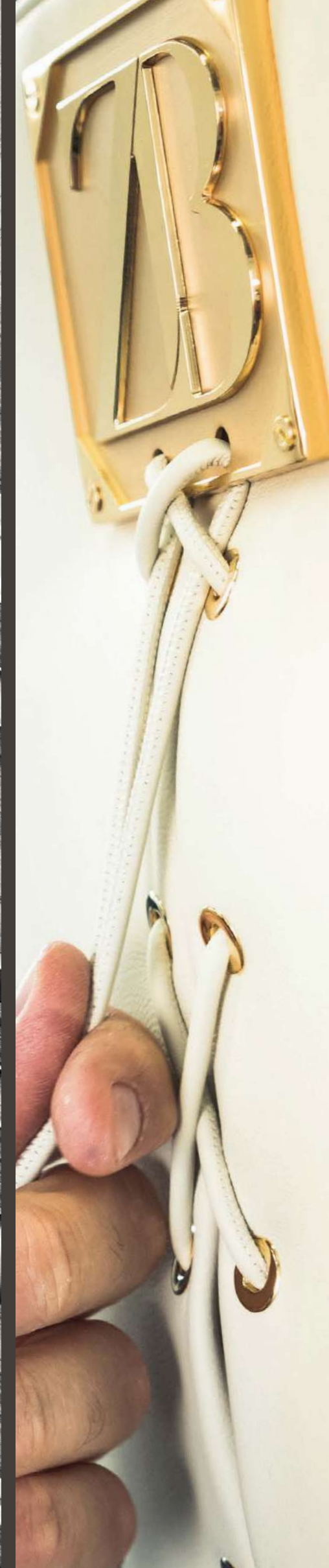

LUXURY CRAFTED IN VERONA

Luxury is crafted. Not made.
Luxury crafted by artisans is the most precious.
Artisans are not all the same.
That's why our craftsmanship is based exclusively in Verona.
To thrive on the heritage of Verona's art and lifestyle.

Il lusso è arte manuale. Non è semplicemente prodotto.
Il lusso realizzato dagli artigiani è il più prezioso.
Gli artigiani non sono tutti uguali.
Per questo la nostra maestria artigianale opera esclusivamente a
Verona. Città custode di un immenso patrimonio artistico e simbolo
di uno stile di vita esclusivo.

Люкс - это ручная работа, а не простой продукт.
Люкс реализован вручную мастерами и более ценен.
Все мастера не похожи друг на друга.
Именно поэтому наши мастера исключительно из Вероны.
Где рождается наследие искусства и образ жизни.

奢侈是匠心创造的艺术。而不仅仅是产品。
匠人所创造的奢侈是最珍贵的。
而匠人并非各个都一样。
我们只用维罗纳的匠人。
因为，这里有独特的生活与艺术底蕴。





Bruno Zampa

Founder, since 1960.



Ruben, craftsman in Bruno Zampa for 18 years.



Anna, final buffer, is checking all the smallest details in our polishing center.



Andrea, quality manager, is carrying out the last finishing touches.



A RELIABLE PARTNER FOR YOUR BUSINESS



Andrea Zampa,
General Manager,
is welcoming clients
in our Gallery.

Working with custom made luxury, one wishes to avoid problems or solve them efficiently. That's why Bruno Zampa grants:

- Budget safe approach
- Focus on custom made projects
- Company credibility, unchanged ownership since 1960
- Clever solutions for "impossible" requests
- Reliability beyond legal warranty

Nel settore del lusso e delle creazioni di alta gamma personalizzate, sono necessarie soluzioni efficienti.

Per questo Bruno Zampa garantisce:

- Rispetto del budget
- Focus su progetti personalizzati
- Solidità aziendale, sempre la stessa proprietà dal 1960
- Soluzioni efficaci per richieste "impossibili"
- Affidabilità oltre le garanzie legali

При работе с элитной продукцией, создаваемой по специальному заказу, каждый хотел бы избежать проблемных ситуаций и эффективно справиться с возникающими сложностями.

Поэтому Bruno Zampa предлагает:

- рациональный финансовый подход
- фокус на индивидуальном проекте
- надежность — руководство компании не менялось с 1960 г
- находчивые решения к твоим «невозможным» запросам
- ответственность и юридическую гарантию

选择高端定制，意味着全程无忧的高效解决方案。

这也正是 Bruno Zampa 向您做出的承诺：

- 符合您的预算设定
- 满足您的定制要求
- 卓越公司信誉，自 1960 年起从未易主
- 以最佳方案将“不可能”变为可能
- 以高于法律要求的标准，成为您的无忧选择





*Matteo De Stefani, architect,
designer of Bruno Zampa collections.*

CUSTOM
MADE
FURNITURE
FOR YOUR
DESIGN





Bruno Zampa is focused on custom made solutions:

- Extended product range, with 15.950 combinations in materials and finishing
- 43% of our overall production is customized and not in the standard range
- Our creative and technical staff is at customer's disposal to customize products and projects
- The appointed Project Manager will be the only interface to deal with

Bruno Zampa è focalizzata su soluzioni personalizzate:

- Ampia gamma disponibile, 15.950 combinazioni di materiali e finiture
- Il 43% della nostra produzione è su misura
- Il nostro staff creativo e tecnico è a disposizione per la personalizzazione di prodotti e progetti
- Il Project Manager assegnato sarà l'unico riferimento dall'avvio alla chiusura del progetto

Bruno Zampa — это индивидуальные решения:

- широкий ассортимент товаров, 15.950 сочетаний материалов и отделки мебели
- 43% нашей продукции нет в каталоге, так как она персонализирована
- Наш дизайнерский и технический персонал в твоём распоряжении, для того чтобы персонализировать модели и проекты
- У тебя будет проект-менеджер, который будет исключительно в твоём распоряжении

Bruno Zampa 专注于定制解决方案:

- 超细化产品分类, 15.950 种材料和饰面组合
- 43% 的产品都无法在目录中找到, 因为它们都是个人定制的
- 我们的创意团队和专业团队为你提供定制的产品和设计
- 你将会有你专属的项目经理

*Mattia, interior designer,
is creating the project's moodboard*

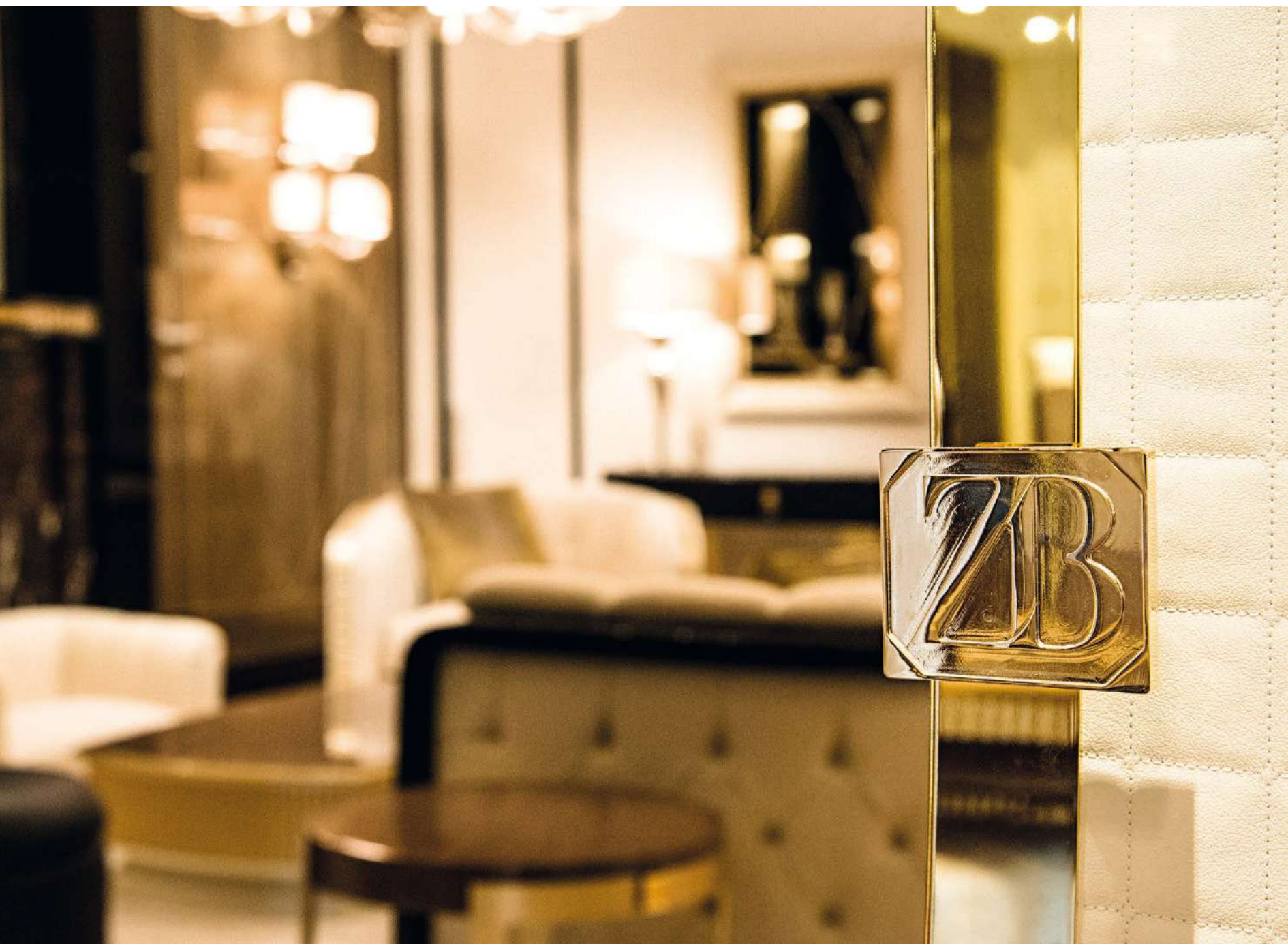

EXPERIENCE THE CRAFTSMANSHIP: COME TO THE VERONA HUB

Luxury cannot be told.
One has to touch it, smell
it and feel it. It can not be
imagined.
In our Verona HUB
customers will experience:
- Our luxury craftsmanship
at work in our 4 production
units: joinery, tailoring,
upholstery, polishing
- 11 projects in our 1.025 m²
Gallery
- The meeting with our
design team

Il lusso non può essere espresso
con parole.
Per comprenderlo è necessario
toccarlo e assaporarlo. Non può
essere semplicemente immaginato.
Nel nostro HUB i clienti possono
vedere e vivere:
- I nostri artigiani del lusso al
lavoro nelle 4 unità produttive:
 falegnameria, sartoria,
 tappezzeria, lucidatura
- 11 progetti ambientati nella
nostra galleria di 1.025 m²
- l'incontro con il nostro team di
progettazione

Роскошь невозможно выразить
словами.
Ее нужно прочувствовать:
прикоснуться к ней и ощутить
ее вкус. Не пытайтесь
представить ее.
В нашем центре в Вероне вас
ждет:
- наше мастерство изготовления
на деле: столярные работы,
подгонка, обивка и полировка
изделий
- 11 проектов в галерее
площадью 1025 м²
- знакомство с командой
дизайнеров

奢侈不可言之。
您必须触于手，嗅于鼻，感于心。
而非凭空想象。
在我们维罗纳的中心，您将体验到：
- 我们四个制作单位的精湛技艺：
细木工、剪裁、内饰和抛光
- 我们 1.025 平方米的展厅，呈现
11 个特色各异的项目
- 与我们的设计团队亲自会面沟通

APOLLO

BED

Struttura in legno massello e multistrati di legno. Testata e giroletto decorati in pelle ricamata. Dettagli in metallo. Imbottiture in poliuretano a quote differenziate. Rete a doghe in legno compresa. Dimensioni previste: queen e king size. Set letto disponibile su richiesta.

Solid wood and plywood structure. Quilted leather bed header and bed frame. Metal details. Multiple densities polyurethane foam padding. Wooden slat included. Available in queen and king size. Bed set available on request.

Каркас из массива дерева и фанеры. Изголовье и каркас кровати отделаны стеганой кожей. Металлические детали. Набивка из пенополиуретана разной плотности. С деревянными ламелями. Доступные размеры: Queen size и King size. Постельное белье можно приобрести по запросу.

实木和胶合板结构。绗缝皮革床头板和床架精细金属配饰。多重密度聚氨酯泡沫填充垫料。含实木板条。可选大号 and 超大号。可根据请求提供床套。



B
E
D
S

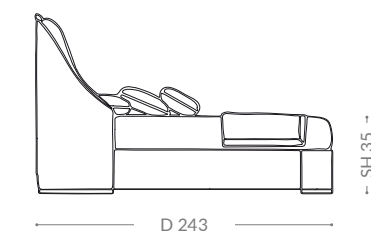
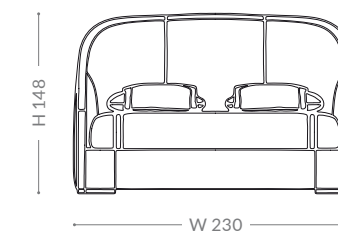

APOLLO King Size
(Recommended mattress cm 200x200)

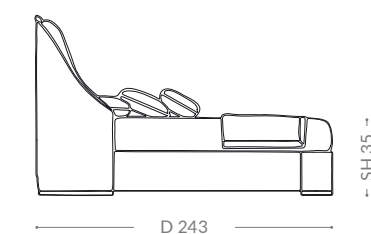
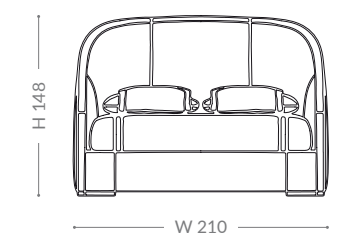

APOLLO Queen Size
(Recommended mattress cm 180x200)

As picture: Apollo bed
In price list: Ambition

Letto e sommier/Bed and sommier/
Кровать и каркас кровати/床和床垫
BZ 901-702 LEATHER DOVE GREY

Parti in metallo/Metal parts/Металлическая фурнитура/金属部件
GOLD
Trapunta/Quilt/Стеганое одеяло/被子
BZ 212-1078 SATIN MASTIC

Plaid/Plaid/Плед/格纹
BZ 215-05 JACQUARD SANDSTONE
Cuscini/Pillows/Подушки/抱枕
BZ 212-1078 SATIN MASTIC
BZ 215-05 JACQUARD SANDSTONE

BERNINI

BED

B
E
D
S

As picture: Bernini bed
In price list: Ambition

Lucidatura/Finishing/Отделка/饰面
80. IVORY MATT
Letto e sommier/Bed and sommier/
Кровать и каркас кровати/床和床垫
BZ 905-5072 LEATHER CHAMPAGNE

Trapunta/Quilt/Стеганое одеяло/被子
BZ 126-52 UNITO IVORY
Plaid/Plaid/Плед/格纹
BZ 184-901 PALMA BEIGE/IVORY

Cuscini/Pillows/Подушки/抱枕
BZ 126-52 UNITO IVORY
BZ 193-10 VELVET BEIGE
BZ 195-071 WAVE BEIGE

Struttura in legno massello e multistrati di legno. Testata decorata con lavorazione *capitoné* e fasce trapuntate. Base in legno di faggio laccata. Imbottiture in poliuretano a quote differenziate. Rete a doghe in legno compresa. Dimensioni previste: queen e king size. Set letto disponibile su richiesta.

Solid wood and plywood structure. Bed header quilted with *capitoné* and vertical bands decorations. Beechwood lacquered base. Multiple densities polyurethane foam padding. Wooden slat included. Available in queen and king size. Bed set available on request.

Каркас из массива дерева и фанеры. Изголовье кровати со стеганой отделкой в виде каретной стяжки и вертикальными полосами. Основа из лакированной древесины бука. Набивка из пенополиуретана разной плотности. С деревянными ламелями. Доступные размеры: Queen size и King size. Постельное белье можно приобрести по запросу.

实木和胶合板结构。加衬垫绗缝软包床头,点缀竖直带形装饰。山毛榉漆木床底板。多重密度聚氨酯泡沫填充垫料。含实木板条。可选大号 and 超大号。可根据请求提供床套。

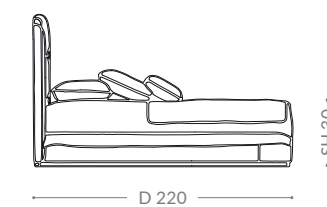
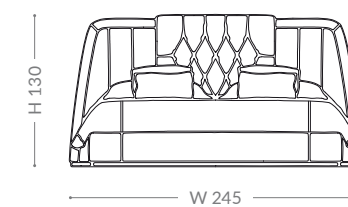

BERNINI King Size
(Recommended mattress cm 200x200)

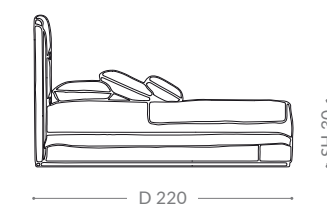
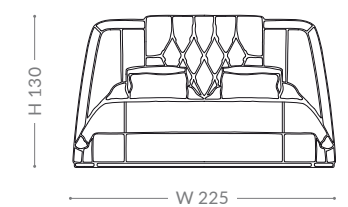

BERNINI Queen Size
(Recommended mattress cm 180x200)

BERNINI WIDE

BED

Struttura in legno massello e multistrati di legno. Testata in versione allargata per contenere i comodini, decorata con lavorazione *capitonné* e fasce trapuntate. Base in legno di faggio laccata. Imbottiture in poliuretano a quote differenziate. Rete a doghe in legno compresa. Dimensioni previste: king size. Set letto disponibile su richiesta.

Solid wood and plywood structure. Enlarged bed header to fit bedside tables; quilted with *capitonné* and vertical bands decorations. Beechwood lacquered base. Multiple densities polyurethane foam padding. Wooden slat included. Available in king size. Bed set available on request.

Каркас из массива дерева и фанеры. Увеличенное изголовье кровати позволяет устанавливать прикроватные тумбочки. Стеганая отделка в виде каретной стяжки и вертикальные полосы. Основа из лакированной древесины бука. Набивка из пенополиуретана разной плотности. С деревянными ламелями. Доступный размер: King size. Постельное белье можно приобрести по запросу.

实木和胶合板结构。放大床头板以便适合床边桌。床头板采用超大软垫绗缝，点缀垂直带形装饰。漆木山毛榉床底板。多重密度聚氨酯泡沫填充垫料。含实木板条。超大床尺寸。可根据请求提供床套。



B E D S

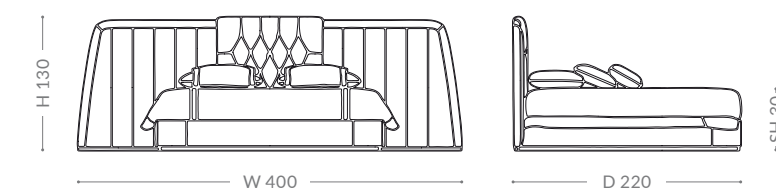

BERNINI WIDE King Size
(Recommended mattress cm 200x200)

As picture: Bernini Wide bed
In price list: Supreme

Lucidatura/Finishing/Отделка/饰面
86. BLACK MATT
Trapunta/Quilt/Стеганое одеяло/被子
BZ 212-0485 SATIN LIGHT GREY

Letto e sommier/Bed and sommier/
Кровать и каркас кровати/床和床垫
BZ 905-5141 LEATHER DARK GREY
BZ 902-N8401 NABUK DARK GREY

Cuscini/Pillows/Подушки/抱枕
BZ 212-0485 SATIN LIGHT GREY
BZ 192-003 CHEVRON GREY
BZ 202-37 VELVET LIGHT GREY

BERNINI XYLO

BED

Struttura in legno massello e multistrati di legno. Testata decorata con lavorazione *capitoné* e fasce trapuntate. Cornice testata e base in noce canaletto. Imbottiture in poliuretano a quote differenziate. Rete a doghe in legno compresa. Dimensioni previste: queen e king size. Set letto disponibile su richiesta.

Solid wood and plywood structure. Bed header quilted with *capitoné* and vertical bands decorations. Canaletto walnut wooden header profile and base. Multiple densities polyurethane foam padding. Wooden slat included. Available in queen and king size. Bed set available on request.

Каркас из массива дерева и фанеры. Изголовье кровати со стеганой отделкой в виде каретной стяжки и вертикальными полосами. Основа и профиль изголовья выполнены из ореха каналетто. Набивка из пенополиуретана разной плотности. С деревянными ламелями. Доступные размеры: Queen size и King size. Постельное белье можно приобрести по запросу.

实木和胶合板结构。加衬垫绗缝软包床头,点缀竖带形装饰。卡纳莱托胡桃木床头轮廓线和底板。多重密度聚氨酯泡沫填充垫料。含实木板条。可选大号 and 超大号。可根据请求提供床套。



B E D S

As picture: Bernini Xylo bed
In price list: Prestige

Lucidatura/Finishing/Отделка/饰面
70. CANALETTO WALNUT MATT
Letto e sommier/Bed and sommier/
Кровать и каркас кровати/床和床垫
BZ 211-0814 VELVET MELANGE BEIGE

Trapunta/Quilt/Стеганое одеяло/被子
BZ 212-1078 SATIN MASTIC
Plaid/Plaid/Плед/格纹
BZ 212-1497 SATIN CAMEL

Cuscini/Pillows/Подушки/抱枕
BZ 212-1078 SATIN MASTIC
BZ 214-01 VELVET CARVED CAMEL
BZ 211-0814 VELVET MELANGE BEIGE

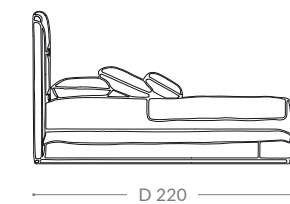
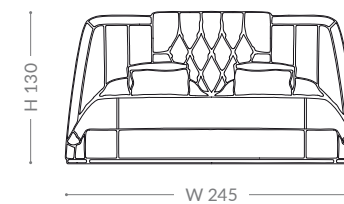

BERNINI XYLO King Size
(Recommended mattress cm 200x200)

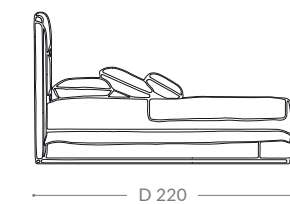
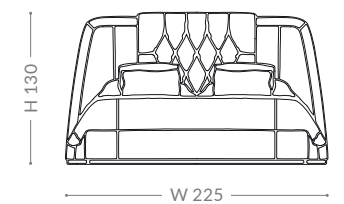

BERNINI XYLO Queen Size
(Recommended mattress cm 180x200)

BERNINI XYLO WIDE

BED



Struttura in legno massello e multistrati di legno. Testata, in versione allargata per contenere i comodini, decorata con lavorazione *capitonné* e fasce trapuntate. Cornice testata e base in noce canaletto. Imbottiture in poliuretano a quote differenziate. Rete a doghe in legno compresa. Dimensioni previste: king size. Set letto disponibile su richiesta.

Solid wood and plywood structure. Enlarged bed header to fit bedside tables; quilted with *capitonné* and vertical bands decorations. Canaletto walnut wooden header profile and base. Multiple densities polyurethane foam padding. Wooden slat included. Available in king size. Bed set available on request.

Каркас из массива дерева и фанеры. Увеличенное изголовье кровати позволяет устанавливать прикроватные тумбочки. Стеганая отделка в виде каретной стяжки и вертикальные полосы. Основа и профиль изголовья выполнены из ореха каналетто. Набивка из пенополиуретана разной плотности. С деревянными ламелями. Доступный размер: King size. Постельное белье можно приобрести по запросу.

实木和胶合板结构。放大床头板以便适合床边桌。床头板采用超大软垫绗缝，点缀竖直带形装饰。卡纳莱托胡桃木床头轮廓线和底板。多重密度聚氨酯泡沫填充垫料。含实木板条。超大床尺寸。可根据请求提供床套。

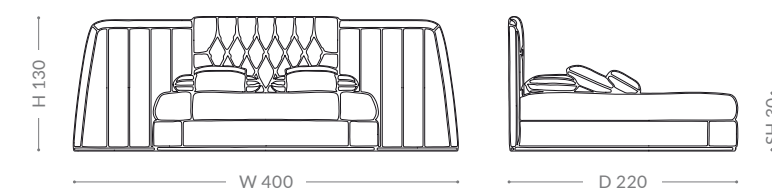

BERNINI XYLO WIDE King Size
(Recommended mattress cm 200x200)

B E D S

As picture: Bernini Xylo
Wide bed

In price list: Ambition/Brilliant

Lucidatura/Finishing/Отделка/饰面
69. CANALETTO WALNUT

Letto e sommier/Bed and sommier/
Кровать и каркас кровати/床和床垫
BZ 901-632 LEATHER LIGHT BROWN

Trapunta/Quilt/Стеганое одеяло/被子
BZ 126-50 UNITO SAND/PEARL

Cuscini/Pillows/Подушки/抱枕
BZ 126-50 UNITO SAND/PEARL
BZ 217-106 VELVET IVORY
BZ 183-901 RAILING WHITE/GOLD

CLEO

BED



Struttura in legno massello e multistrati di legno. Testata in versione allargata per contenere i comodini. Nicchie laterali disponibili in essenza di noce canaletto con luce a LED. Parte centrale composta da formelle imbottite in poliuretano a quote differenziate. Cornice perimetrale e giroletto realizzati in pelle. Rete a doghe in legno compressa. Dimensioni previste: queen e king size. Set letto disponibile su richiesta.

Solid wood and plywood structure. Enlarged bed header to fit bedside tables. Side recesses available in canaletto walnut veneer with LED lighting. Central panels padded in multiple densities polyurethane foam. Leather bed header profile and bed frame. Wooden slat included. Available in queen and king size. Bed set available on request.

Каркас из массива дерева и фанеры. Увеличенное изголовье кровати позволяет устанавливать прикроватные тумбочки. Боковые углубления из шпона ореха каналетто со светодиодной подсветкой. Набивка центральных панелей из пенополиуретана разной плотности. Каркас кровати и профиль изголовья обтянуты кожей. С деревянными ламелями. Доступные размеры: Queen size и King size. Постельное белье можно приобрести по запросу.

实木和胶合板结构。放大床头板以便适合床边桌。侧边的凹陷装饰为卡纳莱托胡桃木饰面板，配 LED 照明。中心床板内填充多种密度的聚氨酯泡沫垫料。皮革床头轮廓线条和床架。含实木板条。可选大号 and 超大号。可根据请求提供床套。

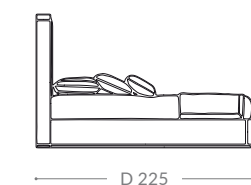
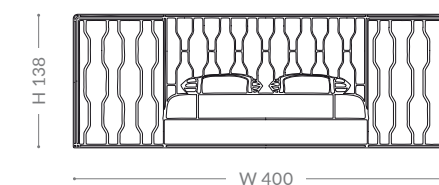

CLEO King Size
(Recommended mattress cm 200x200)

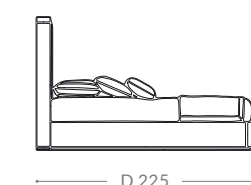
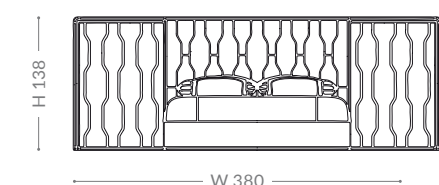

CLEO Queen Size
(Recommended mattress cm 180x200)

B E D S

As picture: Cleo bed
In price list: Exclusive/Brilliant

Lucidatura/Finishing/Отделка/饰面
69. CANALETTO WALNUT - 54. GREY
Letto e sommier/Bed and sommier/
Кровать и каркас кровати/床和床垫
BZ 203-009 BOUCLÉ BLUE
BZ 901-702 LEATHER DOVE GREY

Trapunta/Quilt/Стеганое одеяло/被子
BZ 212-1249 SATIN TAUPE
Plaid/Plaid/Плед/格纹
BZ 212-1078 SATIN MASTIC

Cuscini/Pillows/Подушки/抱枕
BZ 212-1249 SATIN TAUPE
BZ 212-1078 SATIN MASTIC
BZ 203-009 BOUCLÉ BLUE

HERMES

BED



Struttura in legno massello sagomato e multistrati di legno. Disponibile in essenza di legno palissandro. Testata e giroletto imbottiti in poliuretano a quote differenziate. Dettagli in ottone. Rete a doghe in legno compresa. Dimensioni previste: queen e king size. Set letto disponibile su richiesta.

Shaped solid wood and plywood structure. Available in palisander veneer. Bed header and bed frame padded in multiple densities polyurethane foam. Brass details. Wooden slat included. Available in queen and king size. Bed set available on request.

Фигурный каркас из массива дерева и фанеры. Материал: шпон палисандра. Навивка изголовья и каркаса кровати из пенополиуретана разной плотности. Латунные детали. С деревянными ламелями. Доступные размеры: Queen size и King size. Постельное белье можно приобрести по запросу.

实木型材和胶合板结构。花梨木饰面板。床头和床架内填充多种密度的聚氨酯泡沫垫料。黄铜细节装饰。含实木板条。可选大号 and 超大号。可根据请求提供床套。



B E D S

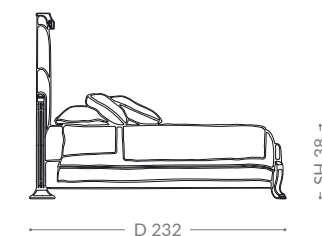
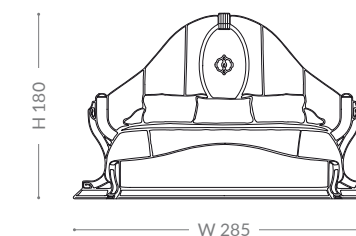

HERMES King Size
(Recommended mattress cm 200x200)

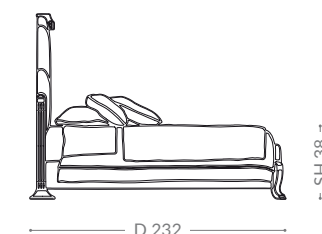
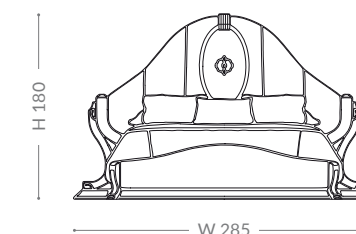

HERMES Queen Size
(Recommended mattress cm 180x200)

As picture: Hermes bed
In price list: Prime/Brilliant

Lucidatura/Finishing/Отделка/饰面
51. SAND - 66. PALISANDER
Parti in metallo/Metal parts/Металлическая фурнитура/金属部件
GOLD

Letto e sommier/Bed and sommier/
Кровать и каркас кровати/床和床垫
BZ 200-902 VELVET BEIGE
Trapunta/Quilt/Стеганое одеяло/被子
BZ 126-50 UNITO SAND/PEARL

Plaid/Plaid/Плед/格纹
BZ 172-901 IVORY FANS
Cuscini/Pillows/Подушки/抱枕
BZ 126-50 UNITO SAND/PEARL
BZ 171-901 MATELASSE IVORY
BZ 200-902 VELVET BEIGE

HERMITAGE

BED



Struttura in legno massello e multistrati di legno. Testata decorata con lavorazione *capitoné*. Applicazione laterale in legno laccato con inserto in specchio bronzo. Imbottiture in poliuretano a quote differenziate. Rete a doghe in legno compresa. Dimensioni previste: queen e king size. Set letto disponibile su richiesta.

Solid wood and plywood structure. *Capitoné* bed header. Side insert in lacquered wood, with bronze mirror inlay. Multiple densities polyurethane foam padding. Wooden slat included. Available in queen and king size. Bed set available on request.

Каркас из массива дерева и фанеры. Изголовье с отделкой в виде каретной стяжки. Боковые вставки из лакированной древесины с зеркальными элементами бронзового оттенка. Набивка из пенополиуретана разной плотности. С деревянными ламелями. Доступные размеры: Queen size и King size. Постельное белье можно приобрести по запросу.

实木和胶合板结构。加衬垫床头。侧面点缀漆木镶板，内嵌镜面黄铜。多重密度聚氨酯泡沫填充垫料。含实木板条。可选大号 and 超大号。可根据请求提供床套。

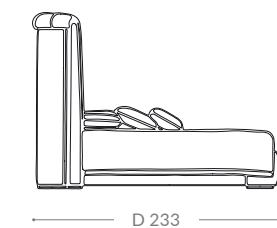
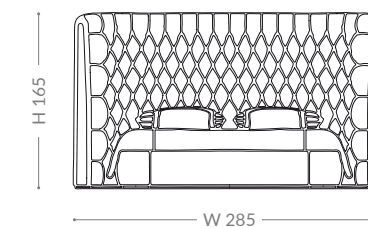

HERMITAGE King Size
(Recommended mattress cm 200x200)

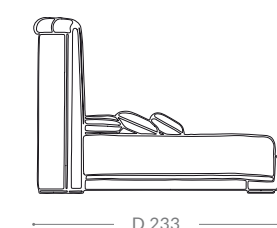
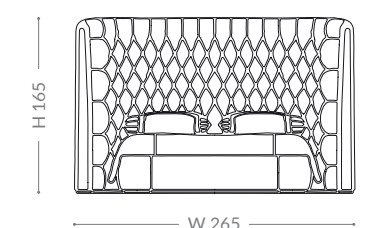

HERMITAGE Queen Size
(Recommended mattress cm 180x200)

B E D S

As picture: Hermitage bed
In price list: Prestige

Lucidatura/Finishing/Отделка/饰面
85. CHOCOLATE MATT
Parti in metallo/Metal parts/Металлическая фурнитура/金属部件
GOLD

Letto e sommier/Bed and sommier/
Кровать и каркас кровати/床和床垫
BZ 216-120 VELVET RHUBARB
Trapunta/Quilt/Стеганое одеяло/被子
BZ 212-1078 SATIN MASTIC

Cuscini/Pillows/Подушки/抱枕
BZ 212-1078 SATIN MASTIC
BZ 203-008 BOUCLÉ PLUM
BZ 216-120 VELVET RHUBARB

HORIZON

BED

Struttura in legno massello e multistrati di legno curvato. Testata decorata con ricamo. Piedini e profili in metallo satinato. Imbottiture in poliuretano a quote differenziate. Rete a doghe in legno compresa. Dimensioni previste: queen e king size. Set letto disponibile su richiesta.

Solid wood and curved plywood structure. Quilted bed header. Satin metal feet and base. Multiple densities polyurethane foam padding. Wooden slat included. Available in queen and king size. Bed set available on request.

Каркас из массива дерева и изогнутой фанеры. Стеганое изголовье. Ножки и основа из сатинированного металла. Набивка из пенополиуретана разной плотности. С деревянными ламелями. Доступные размеры: Queen size и King size. Постельное белье можно приобрести по запросу.

实木和曲面胶合板结构。绗缝床头。缎纹金属脚和把手。多重密度聚氨酯泡沫填充垫料。含实木板条。可选大号 and 超大号。可根据请求提供床套。



B E D S

As picture: Horizon bed
In price list: Supreme/Brilliant

Lucidatura/Finishing/Отделка/饰面
57. CHOCOLATE
85. CHOCOLATE MATT
Parti in metallo/Metal parts/Металлическая фурнитура/金属部件
SATIN GOLD

Letto e sommier/Bed and sommier/
Кровать и каркас кровати/床和床垫
BZ 902-N8405 NABUK DOVE GREY
Trapunta/Quilt/Стеганое одеяло/被子
BZ 212-1078 SATIN MASTIC

Cuscini/Pillows/Подушки/抱枕
BZ 212-1078 SATIN MASTIC
BZ 198-05 BOUCLÉ TWINE

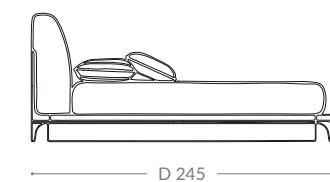
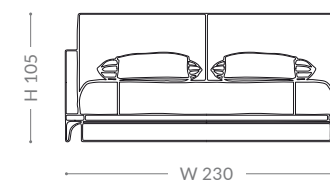

HORIZON King Size
(Recommended mattress cm 200x200)

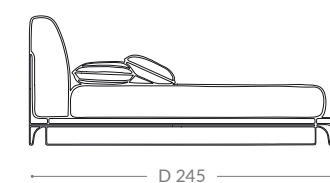
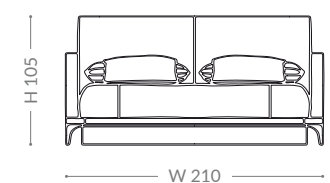

HORIZON Queen Size
(Recommended mattress cm 180x200)

JUNO

BED



Struttura in legno massello e multistrati di legno. Disponibile in essenza di ebano makassar. Pannello centrale decorato con lavorazione *capitoné*. Colonne decorative in legno con elementi verticali in ottone. Profili e dettagli in metallo. Imbottiture in poliuretano a quote differenziate. Rete a doghe in legno compresa. Dimensioni previste: queen e king size. Set letto disponibile su richiesta.

Solid wood and plywood structure. Available in makassar ebony veneer. *Capitoné* bed header central panel. Wooden decorative column, with brass decorations. Metal profiles and details. Multiple densities polyurethane foam padding. Wooden slat included. Available in queen and king size. Bed set available on request.

Каркас из массива дерева и фанеры. Материал: шпон макаassarского эбена. Центральная панель изголовья кровати с отделкой в виде каретной стяжки. Деревянные декоративные ножки-колонны с латунной отделкой. Металлические профили и детали. Навивка из пенополиуретана разной плотности. С деревянными ламелями. Доступные размеры: Queen size и King size. Постельное белье можно приобрести по запросу.

实木和胶合板结构。孟加锡乌木饰面板。床头中心床板点缀软垫绗缝木制装饰立柱，点缀黄铜装饰。金属轮廓线条及细节装饰。多重密度聚氨酯泡沫填充垫料。含实木板条。可选大号 and 超大号。可根据请求提供床套。

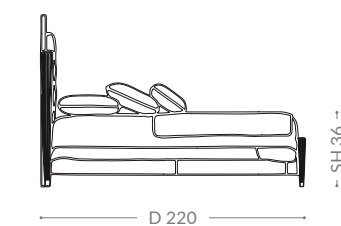
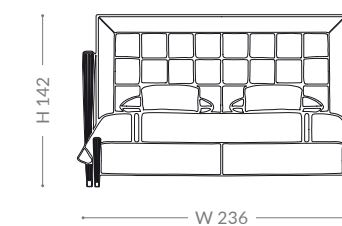

JUNO King Size
(Recommended mattress cm 200x200)

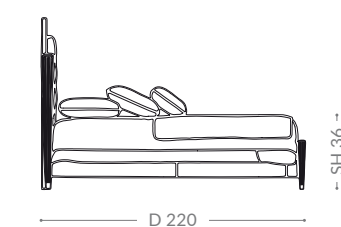
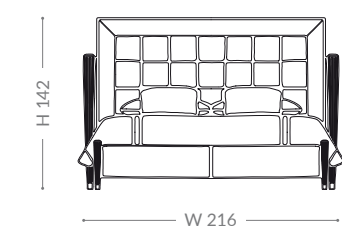

JUNO Queen Size
(Recommended mattress cm 180x200)

BEDS

As picture: Juno bed
In price list: Ambition/Brilliant

Lucidatura/Finishing/Отделка/饰面
65. MAKASSAR
57. CHOCOLATE
Parti in metallo/Metal parts/Металлическая фурнитура/金属部件
GOLD

Letto e sommier/Bed and sommier/
Кровать и каркас кровати/床和床垫
BZ 901-891 LEATHER IVORY
Trapunta/Quilt/Стеганое одеяло/被子
BZ 126-52 UNITO IVORY

Plaid/Plaid/Плед/格纹
BZ 194-070 STRIPE BEIGE
Cuscini/Pillows/Подушки/抱枕
BZ 126-52 UNITO IVORY
BZ 193-10 VELVET BEIGE
BZ 194-070 STRIPE BEIGE

KING

BED



As picture: King bed
In price list: Prestige

Parti in metallo/Metal parts/Металлическая фурнитура/金属部件
TITANIUM

Letto e sommier/Bed and sommier/Кровать и каркас кровати/床和床垫
BZ 118-094 VELVET GREY

Trapunta/Quilt/Стеганое одеяло/被子
BZ 126-51 UNITO GREY/PEARL
Cuscini/Pillows/Подушки/抱枕
BZ 126-51 UNITO GREY/PEARL
BZ 118-094 VELVET GREY

Struttura in legno massello e multistrati di legno. Testata decorata con lavorazione a trapunta. Piedini in fusione di ottone. Imbottiture in poliuretano a quote differenziate. Rete a doghe in legno compressa. Dimensioni previste: standard, queen e king size. Set letto disponibile su richiesta.

Solid wood and plywood structure. Quilted bed header. Cast brass feet. Multiple densities polyurethane foam padding. Wooden slat included. Available in standard, queen and king size. Bed set available on request.

Каркас из массива дерева и фанеры. Стеганое изголовье. Ножки из литейной латуни. Набивка из пенополиуретана разной плотности. С деревянными ламелями. Доступные размеры: стандартный, Queen size и King size. Постельное белье можно приобрести по запросу.

实木和胶合板结构。绗缝床头。铸黄铜床脚。多重密度聚氨酯泡沫填充垫料。含实木板条。可选标准、大号 and 超大号。可根据请求提供床套。

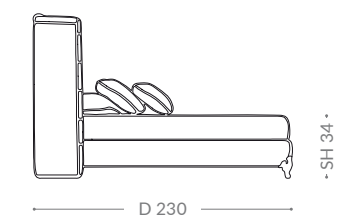
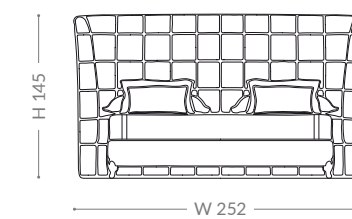

KING King Size
(Recommended mattress cm 200x200)

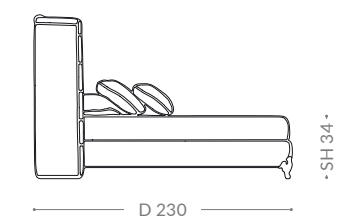
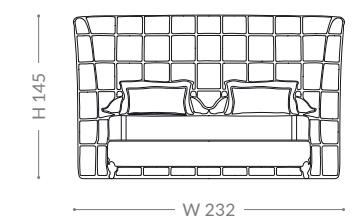

KING Queen Size
(Recommended mattress cm 180x200)

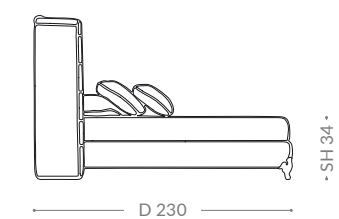
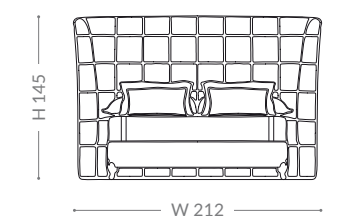

KING Standard Size
(Recommended mattress cm 160x200)

MADISON

BED



Struttura in legno massello; basamento in legno decorato. Selle copritestata in pelle ricamata con fibbia in ottone. Imbottiture in poliuretano espanso a quote differenziate. Rete a doghe in legno compressa. Dimensioni previste: standard, queen e king size. Set letto disponibile su richiesta.

Solid wood structure; wooden decorated base. Leather bed header covers, with brass buckle. Multiple densities polyurethane foam padding. Wooden slat included. Available in standard, queen and king size. Bed set available on request.

Каркас из массива дерева, деревянная основа с отделкой. Кожаные чехлы для изголовья кровати с застежкой из латуни. Набивка из пенополиуретана разной плотности. С деревянными ламелями. Доступные размеры: стандартный, Queen size и King size. Постельное белье можно приобрести по запросу.

实木结构，木饰床架。黄铜口装饰包皮床头多重密度聚氨酯泡沫填充垫料。含实木板条。可选标准、大号和超大号。可根据请求提供床套。

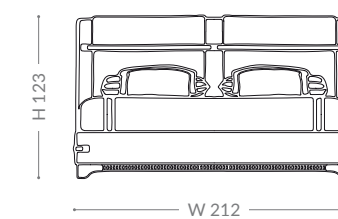

MADISON King Size
(Recommended mattress cm 200x200)

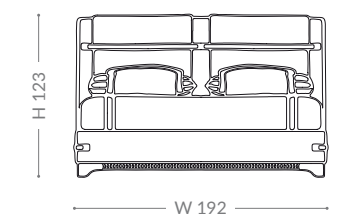

MADISON Queen Size
(Recommended mattress cm 180x200)

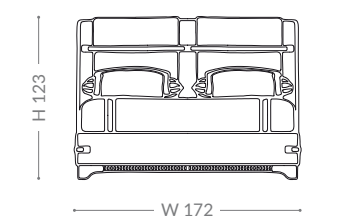

MADISON Standard Size
(Recommended mattress cm 160x200)

B E D S

As picture: Madison bed
In price list: Prestige/Brilliant

Lucidatura/Finishing/Отделка/饰面
54. GREY
Parti in metallo/Metal parts/Металлическая фурнитура/金属部件
DIAMOND TITANIUM

Letto e sommier/Bed and sommier/
Кровать и каркас кровати/床和床垫
BZ 216-222 VELVET LIGHT GREY
BZ 906-2006 LEATHER TAUPE
Трапунта/Quilt/Стеганое одеяло/被子
BZ 126-51 UNITO GREY/PEARL

Cuscini/Pillows/Подушки/抱枕
BZ 126-51 UNITO GREY/PEARL
BZ 214-03 VELVET CARVED BLUE
BZ 216-222 VELVET LIGHT GREY

OCEAN

BED



Struttura in legno massello e multistrati di legno. Testata decorata con lavorazione *capitoné*. Cornice testata in noce canaletto con applicazione in metallo satinato. Imbottiture in poliuretano a quote differenziate. Rete a doghe in legno compresa. Dimensioni previste: queen e king size. Set letto disponibile su richiesta.

Solid wood and plywood structure. *Capitoné* bed header. Canaletto walnut wooden bed header profile, with metal satin decoration. Multiple densities polyurethane foam padding. Wooden slat included. Available in queen and king size. Bed set available on request.

Каркас из массива дерева и фанеры. Изголовье с отделкой в виде каретной стяжки. Профиль изголовья выполнен из древесины ореха каналетто и украшен сатинованным металлом. Набивка из пенополиуретана разной плотности. С деревянными ламелями. Доступные размеры: Queen size и King size. Постельное белье можно приобрести по запросу.

实木和胶合板结构。加衬垫床头。卡纳莱托胡桃木床头轮廓线，点缀缎纹金属装饰。多重密度聚氨酯泡沫填充垫料。含实木板条。可选大号 and 超大号。可根据请求提供床套。

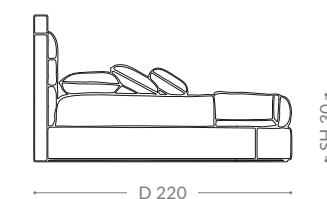
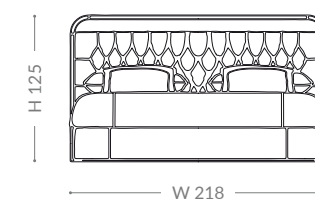

OCEAN King Size
(Recommended mattress cm 200x200)

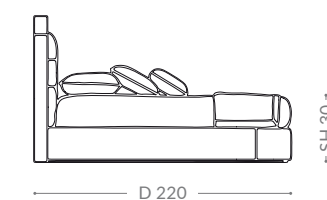
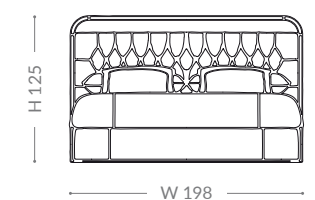

OCEAN Queen Size
(Recommended mattress cm 180x200)

As picture: Ocean bed
In price list: Ambition/Brilliant

Lucidatura/Finishing/Отделка/饰面
69. CANALETTO WALNUT
94. TAUPE
Parti in metallo/Metal parts/Металлическая фурнитура/金属部件
SATIN GOLD

Letto e sommier/Bed and sommier/
Кровать и каркас кровати/床和床垫
BZ 906-2007 LEATHER MOKA
Trapunta/Quilt/Стеганое одеяло/被子
BZ 212-1078 SATIN MASTIC

Plaid/Plaid/Плед/格纹
BZ 213-03 SHANTUNG PUTTY
Cuscini/Pillows/Подушки/抱枕
BZ 212-1078 SATIN MASTIC
BZ 212-2836 SATIN MALVA
BZ 210-02 PLUM FLOWER

OVERWALL

BED

Struttura in legno massello e multistrati di legno. Cornice testata in noce canaletto con luce a LED disponibile su richiesta. Parte interna decorata in pelle ricamata. Imbottiture in poliuretano a quote differenziate. Rete a doghe in legno compresa. Dimensioni previste: queen e king size. Set letto disponibile su richiesta.

Solid wood and plywood structure. Canaletto wooden bed header frame, with LED lighting on request; inner part with quilted leather decoration. Multiple densities polyurethane foam padding. Wooden slat included. Available in queen and king size. Bed set available on request.

Каркас из массива дерева и фанеры. Рама изголовья кровати из древесины ореха каналетто, со светодиодной подсветкой можно приобрести по запросу. Внутри украшена стеганой кожей. Набивка из пенополиуретана разной плотности. С деревянными ламелями. Доступные размеры: Queen size и King size. Постельное белье можно приобрести по запросу.

实木和胶合板结构。卡纳莱托实木床头板，可应求提供LED照明。内侧部分饰以绗缝皮革。多重密度聚氨酯泡沫填充垫料。含实木板条。可选大号 and 超大号。可根据请求提供床套。

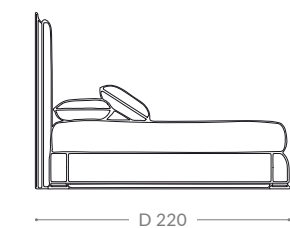
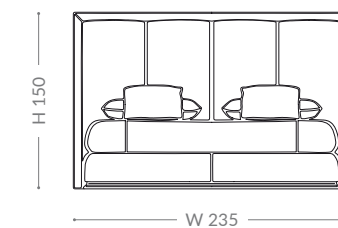

OVERWALL King Size
(Recommended mattress cm 200x200)

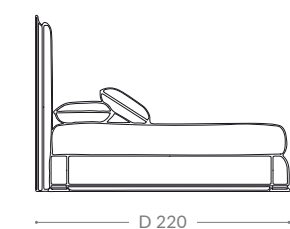
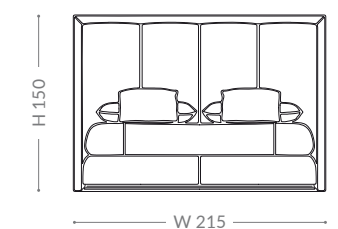

OVERWALL Queen Size
(Recommended mattress cm 180x200)

B E D S

As picture: Overwall bed
In price list: Ambition/Brilliant/
Led lighting on request

Lucidatura/Finishing/Отделка/饰面
69. CANALETTO WALNUT
57. CHOCOLATE

Letto e sommier/Bed and sommier/
Кровать и каркас кровати/床和床垫
BZ 906-2005 LEATHER OASI
Трапунта/Quilt/Стеганое одеяло/被子
BZ 212-1078 SATIN MASTIC

Cuscini/Pillows/Подушки/抱枕
BZ 213-03 SHANTUNG PUTTY
BZ 218-206 VELVET CARVED BROWN

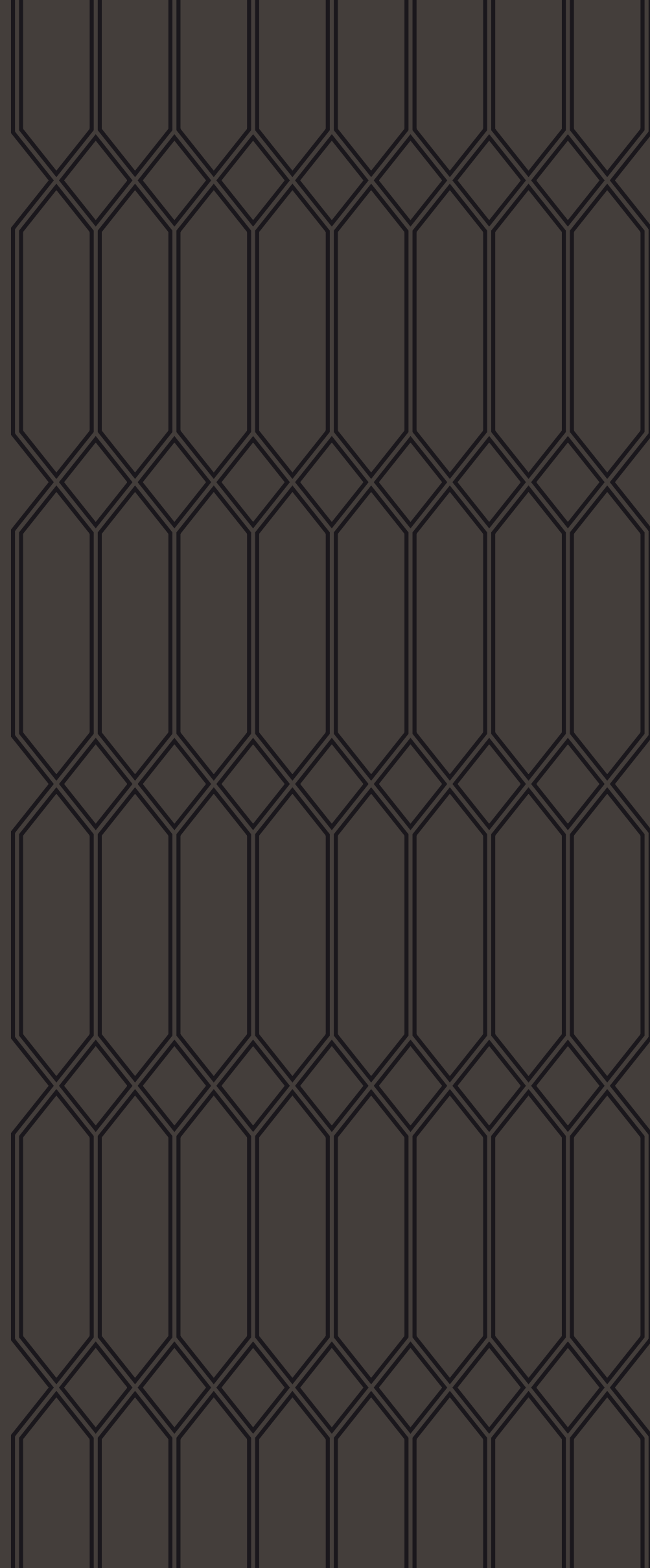

ZB

BEDSIDE TABLES



BUSTER

BEDSIDE TABLE

BEDSIDE TABLES



As picture: Buster bedside table
In price list: Brilliant



Lucidatura/Finishing/Отделка/饰面
51. SAND
64. CANALETTO WALNUT

Parti in metallo/Metal parts/Металлическая фурнитура/金属部件
GOLD

Struttura in legno massello e multistrati di legno. Piedini in legno intagliati a mano. Piano disponibile in essenza di noce canaletto, ebano makassar o marmo. Maniglie in ottone.

Solid wood and plywood structure. Hand-carved wooden feet. Top available in canaletto walnut veneer, makassar ebony veneer or marble. Brass handles.

Каркас из массива дерева и фанеры. Деревянные ножки ручной работы. Доступные материалы столешницы: шпон ореха каналетто или макассарского эбена, мрамор. Латунные ручки.

实木和胶合板结构。手工雕刻木脚。台面可选用卡纳莱托胡桃木饰面板、孟加锡乌木饰面板或大理石。黄铜把手。

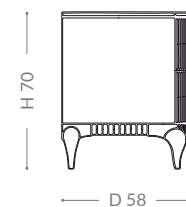
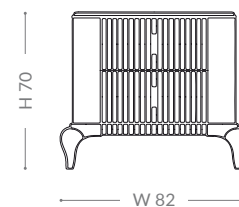

CLARK

BEDSIDE TABLE



As picture: Clark bedside table
In price list: Brilliant

Lucidatura/Finishing/Отделка/饰面
54. GREY

Struttura in legno massello, multistrati di legno e MDF. Cassetti con decorazione in bassorilievo. Disponibile in legno laccato.

Solid wood, plywood and MDF structure. Drawers with low relief decoration. Available in lacquered wood.



BEDSIDE TABLES

Каркас из массива дерева, фанеры и МДФ. Ящики украшены барельефом. Материал: лакированная древесина.

实木、胶合板和中密度纤维板结构。抽屉点缀浅浮雕装饰。漆木质地。

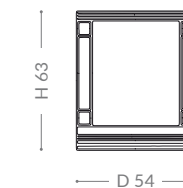
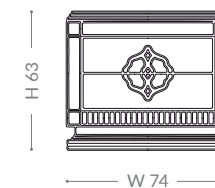

ELYPSE

BEDSIDE TABLE

BEDSIDE TABLES



As picture: Elypse bedside table
In price list: Prime

Lucidatura/Finishing/Отделка/饰面
100. GREY MATT

Parti in metallo/Metal parts/Металлическая фурнитура/金属部件
TITANIUM

Materiale/Material/Материал/材料
BZ 906-2005 LEATHER OASI

Struttura in multistrati di legno curvato e legno massello. Parte esterna decorata in pelle ricamata. Parte interna rivestita in pelle. Piano disponibile in legno laccato o marmo.

Curved plywood and solid wood structure. Quilted leather outer structure. Internal padded in leather. Top available in lacquered wood or marble.

Каркас из изогнутой фанеры и массива дерева. Наружная отделка стеганой кожей. Внутри обита кожей. Доступные материалы столешницы: лакированная древесина или мрамор.

曲面胶合板和实木结构外侧结构为衍缝皮革。内侧结构加皮革衬垫。桌面可选用漆木或大理石。

ELYPSE

BEDSIDE TABLE



As picture: Elypse bedside table
In price list: Brilliant/Precious stone

Lucidatura/Finishing/Отделка/饰面
57. CHOCOLATE
Marmo/Marble/Мрамор/大理石
EMPERADOR DARK

Parti in metallo/Metal parts/Металлическая фурнитура/金属部件
GOLD

Materiale/Material/Материал/材料
BZ 906-2003 LEATHER
DARK BROWN

BEDSIDE TABLES

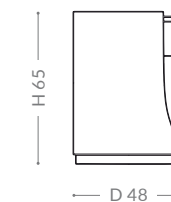
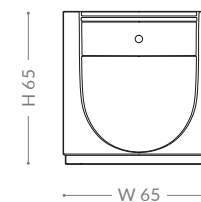

GLENN

BEDSIDE TABLE

BEDSIDE TABLES



As picture: Glenn bedside table
In price list: Brilliant

Lucidatura/Finishing/Отделка/饰面
51. SAND

Parti in metallo/Metal parts/Металлическая фурнитура/金属部件
GOLD

Materiale/Material/Материал/材料
BZ 901-891 LEATHER IVORY

Struttura in legno massello e multistrati di legno. Piano e parte esterna rivestiti in pelle. Fronte cassetti decorati in pelle ricamata. Maniglie in ottone.

Solid wood and plywood structure. Top and outer structure padded in leather. Quilted leather front drawers. Brass handles.

Каркас из массива дерева и фанеры. Кожаная обивка сверху и снаружи. Фасады выдвижных ящиков отделаны стеганой кожей. Латунные ручки.

实木和胶合板结构。台面和外侧结构加皮革衬里。前部抽屉采用绗缝皮革。黄铜把手。

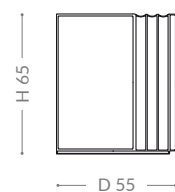
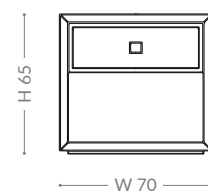

HERMES

BEDSIDE TABLE



As picture: Hermes bedside table
In price list: Brilliant

Lucidatura/Finishing/Отделка/饰面
51. SAND
66. PALISANDER

Parti in metallo/Metal parts/Металлическая фурнитура/金属部件
GOLD

Materiale/Material/Материал/材料
BZ 905-5234 LEATHER
BEIGE

Struttura in legno massello, multistrati di legno curvato e MDF. Disponibile in essenza di palissandro. Fronte cassetto rivestito in pelle. Maniglia in metallo.

Solid wood, curved plywood and MDF structure. Available in palisander veneer. Front drawer padded in leather. Metal handle.

Каркас из массива дерева, изогнутой фанеры и МДФ. Материал: шпон палисандра. Фасад ящика обит кожей. Металлическая ручка.

实木、曲面胶合板和中密度纤维板结构。花梨木饰面板。前侧抽屉加皮革衬里。金属把手。

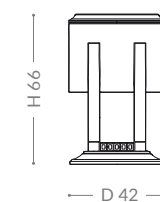
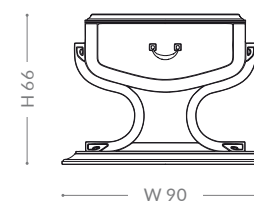

BEDSIDE TABLES

HORIZON

BEDSIDE TABLE

BEDSIDE TABLES



As picture: Horizon bedside table
In price list: Brilliant

Lucidatura/Finishing/Отделка/饰面
51. SAND
69. CANALETTO WALNUT

Parti in metallo/Metal parts/Металлическая фурнитура/金属部件
SATIN GOLD

Struttura in legno massello e multistrati di legno. Disponibile in essenza di noce canaletto. Piedini frontali e maniglia in metallo satinato.

Solid wood and plywood structure. Available in canaletto walnut veneer. Satin metal front feet and handle.

Каркас из массива дерева и фанеры. Материал: шпон ореха каналетто. Передние ножки и ручка из сатинированного металла.

实木和胶合板结构。卡纳莱托胡桃木饰面板。缎纹金属前柜脚和把手。

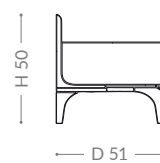
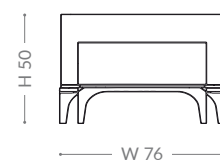

OCEAN I

BEDSIDE TABLE



BEDSIDE TABLES

As picture: Ocean I bedside table
In price list: Brilliant

Lucidatura/Finishing/Отделка/饰面
94. TAUPE

Parti in metallo/Metal parts/Металлическая фурнитура/金属部件
SATIN GOLD

Materiale/Material/Материал/材料
BZ 906-2007 LEATHER MOKA

Struttura in metallo satinato e multistrati di legno curvato. Disponibile in legno laccato. Decorazione su cassetto frontale in pelle ricamata.

Satin metal and curved plywood structure. Available in lacquered wood. Front drawer padded in quilted leather.

Каркас из сатинированного металла и изогнутой фанеры. Материал: лакированная древесина. Фасад ящика обит стеганой кожей.

缎纹金属和曲面胶合板结构。漆木质地。前侧抽屉加绗缝皮革衬里。

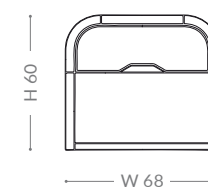

OCEAN II

BEDSIDE TABLE

BEDSIDE TABLES



As picture: Ocean II bedside table
In price list: Prime

Lucidatura/Finishing/Отделка/饰面
81. SAND MATT



Parti in metallo/Metal parts/Металлическая фурнитура/金属部件
SATIN GOLD

Materiale/Material/Материал/材料
BZ 901-891 LEATHER IVORY

Struttura in metallo satinato e multistrati di legno curvato. Disponibile in legno laccato. Decorazione su cassetto frontale in pelle ricamata.

Satin metal and curved plywood structure. Available in lacquered wood. Front drawer padded in quilted leather.

Каркас из сатинированного металла и изогнутой фанеры. Материал: лакированная древесина. Фасад ящика обит стеганой кожей.

缎纹金属和曲面胶合板结构。漆木质地。前侧抽屉加绗缝皮革衬里。

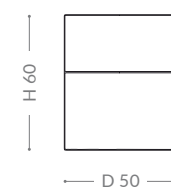
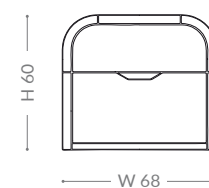

REMINGTON

BEDSIDE TABLE



As picture: Remington bedside table
In price list: Brilliant

Lucidatura/Finishing/Отделка/饰面
57. CHOCOLATE



Parti in metallo/Metal parts/Металлическая фурнитура/金属部件
GOLD

Materiale/Material/Материал/材料
BZ 901-891 LEATHER IVORY

BEDSIDE TABLES

Struttura in legno massello, multistrati di legno e MDF. Piano in legno laccato. Parte laterale e cassette decorati in pelle ricamata. Dettagli e maniglie in ottone. Colonne decorative in legno con fresature verticali.

Solid wood, plywood and MDF structure. Lacquered wooden top. Quilted leather side parts and drawers. Brass handles and details. Wooden columns with fluted decorations.

Каркас из массива дерева, фанеры и МДФ. Столешница из лакированной древесины. Боковые части и выдвижные ящики из стеганой кожи. Латунные ручки и детали. Деревянные ножки-колонны с рифлеными украшениями.

实木、胶合板和中密度纤维板结构。漆木桌面。侧面部件和抽屉采用绗缝皮革。黄铜把手和配饰。五斗柜木制脚凹槽装饰。

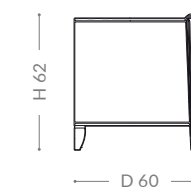
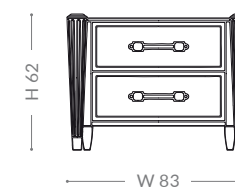

STUART

BEDSIDE TABLE

BEDSIDE TABLES



As picture: Stuart bedside table
In price list: Prime/
Precious stone

Lucidatura/Finishing/Отделка/饰面
81. SAND MATT
Marmo/Marble/Мрамор/大理石
CALACATTA CROMA-ARISTON



Parti in metallo/Metal parts/Металлическая фурнитура/金属部件
SATIN GOLD

Materiale/Material/Материал/材料
BZ 905-5072 LEATHER CHAMPAGNE

Struttura in multistrati di legno curvato e MDF. Piano disponibile in noce canaletto o marmo. Pannello laterale rivestito in pelle con inserto ricamato. Maniglie in metallo satinato.

Curved plywood and MDF structure. Top available in canaletto walnut veneer or marble. Side panel padded in leather with quilted decoration. Satin metal handles.

Каркас из изогнутой фанеры и МДФ. Доступные материалы столешницы: шпон ореха каналетто или мрамор. Боковые панели обиты кожей со стеганой отделкой. Ручки из сатирированного металла.

曲面胶合板和中密度纤维板结构。台面可选用卡纳莱托胡桃木饰面板或大理石。侧镶板加皮革衬里，点缀衍缝装饰。缎纹金属把手。

STUART

BEDSIDE TABLE



As picture: Stuart bedside table
In price list: Prime

Lucidatura/Finishing/Отделка/饰面
70. CANALETTO WALNUT MATT
89. TAUPE MATT



Parti in metallo/Metal parts/Металлическая фурнитура/金属部件
SATIN GOLD

Materiale/Material/Материал/材料
BZ 901-632 LEATHER LIGHT BROWN

BEDSIDE TABLES

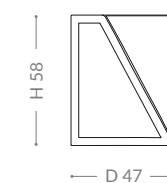
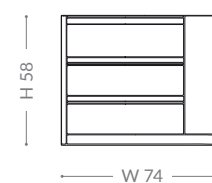

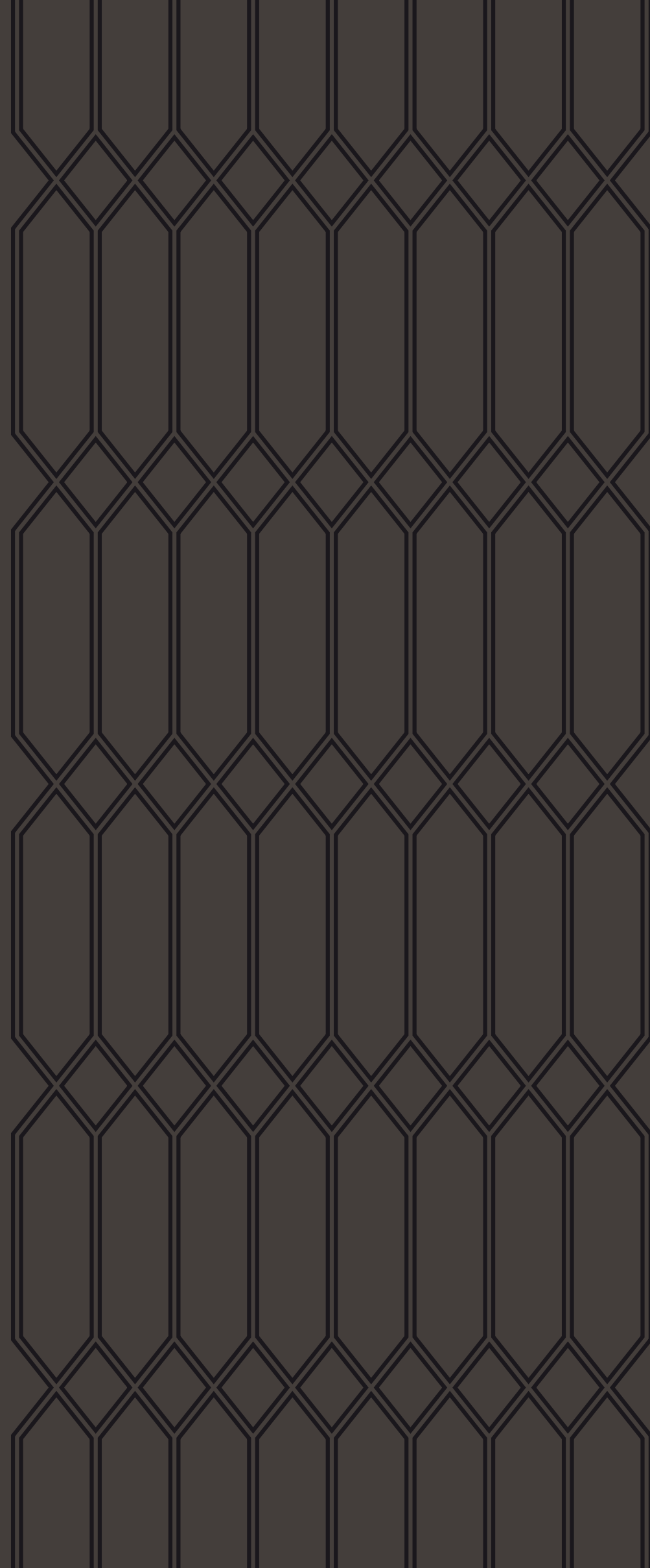

ZB

CHEST
OF DRAWERS



BUSTER

CHEST OF DRAWERS

Struttura in legno massello e multistrati di legno. Piedini in legno intagliati a mano. Piano disponibile in essenza di noce canaletto, ebano makassar o marmo. Maniglie in ottone.

Solid wood and plywood structure. Hand-carved wooden feet. Top available in canaletto walnut veneer, makassar ebony veneer or marble. Brass handles.

Каркас из массива дерева и фанеры. Деревянные ножки ручной работы. Доступные материалы столешницы: шпон ореха каналетто или макассарского эбена, мрамор. Латунные ручки.

实木和胶合板结构。手工雕刻木脚。台面可选用卡纳莱托胡桃木饰面板、孟加锡乌木饰面板或大理石。黄铜把手。



CHEST OF DRAWERS

As picture: Buster chest of drawers
In price list: Brilliant

Lucidatura/Finishing/Отделка/饰面
57. CHOCOLATE
65. MAKASSAR

Parti in metallo/Metal parts/Металлическая фурнитура/金属部件
DIAMOND GOLD

BUSTER

CHEST OF DRAWERS

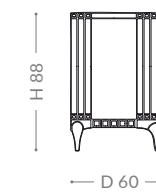
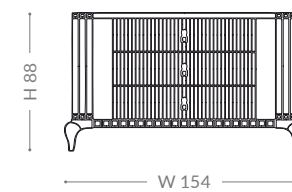

CHEST OF DRAWERS

As picture: Buster chest of drawers
In price list: Brilliant

Lucidatura/Finishing/Отделка/饰面
51. SAND
63. WHITENED CANALETTO WALNUT

Parti in metallo/Metal parts/Металлическая фурнитура/金属部件
DIAMOND GOLD

DEANNA

CHEST OF DRAWERS



CHEST OF DRAWERS

As picture: Deanna chest of drawers
In price list: Brilliant

Lucidatura/Finishing/Отделка/饰面
57. CHOCOLATE
69. CANALETTO WALNUT

Parti in metallo/Metal parts/Металлическая фурнитура/金属部件
SATIN GOLD

Struttura in legno massello e multistrati di legno. Disponibile in essenza di noce canaletto. Piedini frontali e maniglie in metallo satinato.

Solid wood and plywood structure. Available in canaletto walnut veneer. Front feet and handles in satin metal.

Каркас из массива дерева и фанеры. Материал: шпон ореха каналетто. Передние ножки и ручки из сатинированного металла.

实木和胶合板结构。卡纳莱托胡桃木饰面板。前脚和把手为缎纹金属质地。

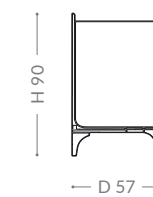
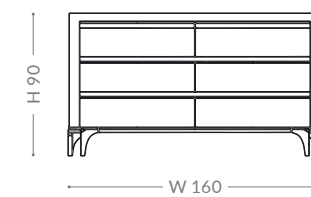

GLENN

CHEST OF DRAWERS



Struttura in legno massello e multistrati di legno. Piano e parte esterna rivestiti in pelle. Fronte cassetti decorati in pelle ricamata. Maniglie in ottone.

Solid wood and plywood structure. Top and outer structure padded in leather. Quilted leather front drawers. Brass handles.

Каркас из массива дерева и фанеры. Кожаная обивка сверху и снаружи. Фасады выдвижных ящиков отделаны стеганой кожей. Латунные ручки.

实木和胶合板结构。台面和外侧结构加皮革衬里。前部抽屉采用绗缝皮革。黄铜把手。

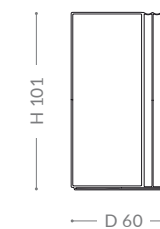
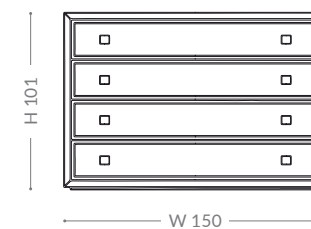
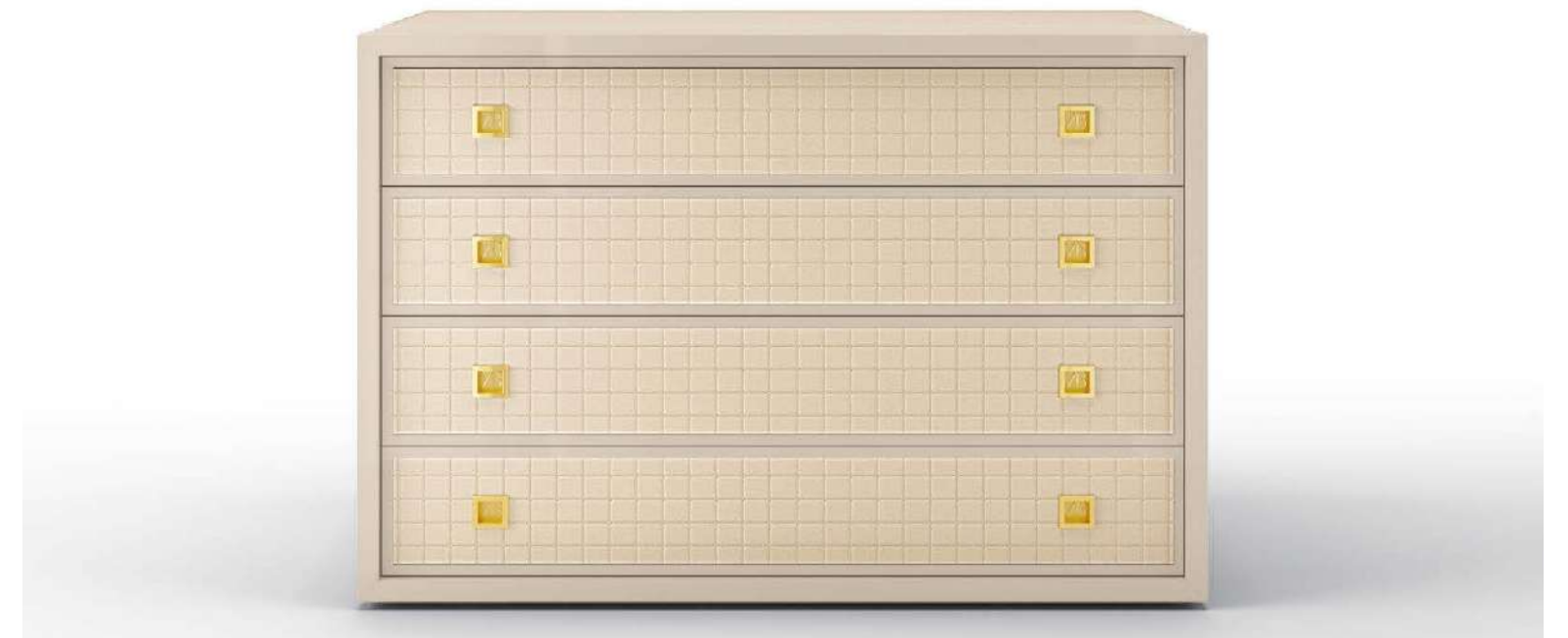

CHEST OF DRAWERS

As picture: Glenn chest of drawers
In price list: Brilliant

Lucidatura/Finishing/Отделка/饰面
51. SAND

Parti in metallo/Metal parts/Металлическая фурнитура/金属部件
GOLD

Materiale/Material/Материал/材料
BZ 901-891 LEATHER IVORY

REMINGTON

CHEST OF DRAWERS



Struttura in legno massello, multistrati di legno e MDF. Piano in legno laccato. Parte laterale e cassetti decorati in pelle ricamata. Dettagli e maniglie in ottone. Colonne decorative in legno con fresature verticali.

Solid wood, plywood and MDF structure. Lacquered wooden top. Quilted leather side parts and drawers. Brass handles and details. Wooden columns with fluted decorations.

Каркас из массива дерева, фанеры и МДФ. Столешница из лакированной древесины. Боковые части и выдвижные ящики из стеганой кожи. Латунные ручки и детали. Деревянные ножки-колонны с рифлеными украшениями.

实木、胶合板和中密度纤维板结构。漆木桌面。侧面部件和抽屉采用绗缝皮革。黄铜把手和配饰。五斗柜木制脚凹槽装饰。

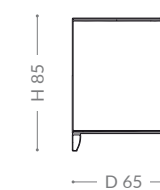

CHEST OF DRAWERS

As picture: Remington chest of drawers
In price list: Brilliant

Lucidatura/Finishing/Отделка/饰面
57. CHOCOLATE

Parti in metallo/Metal parts/Металлическая фурнитура/金属部件
GOLD

Materiale/Material/Материал/材料
BZ 901-891 LEATHER IVORY

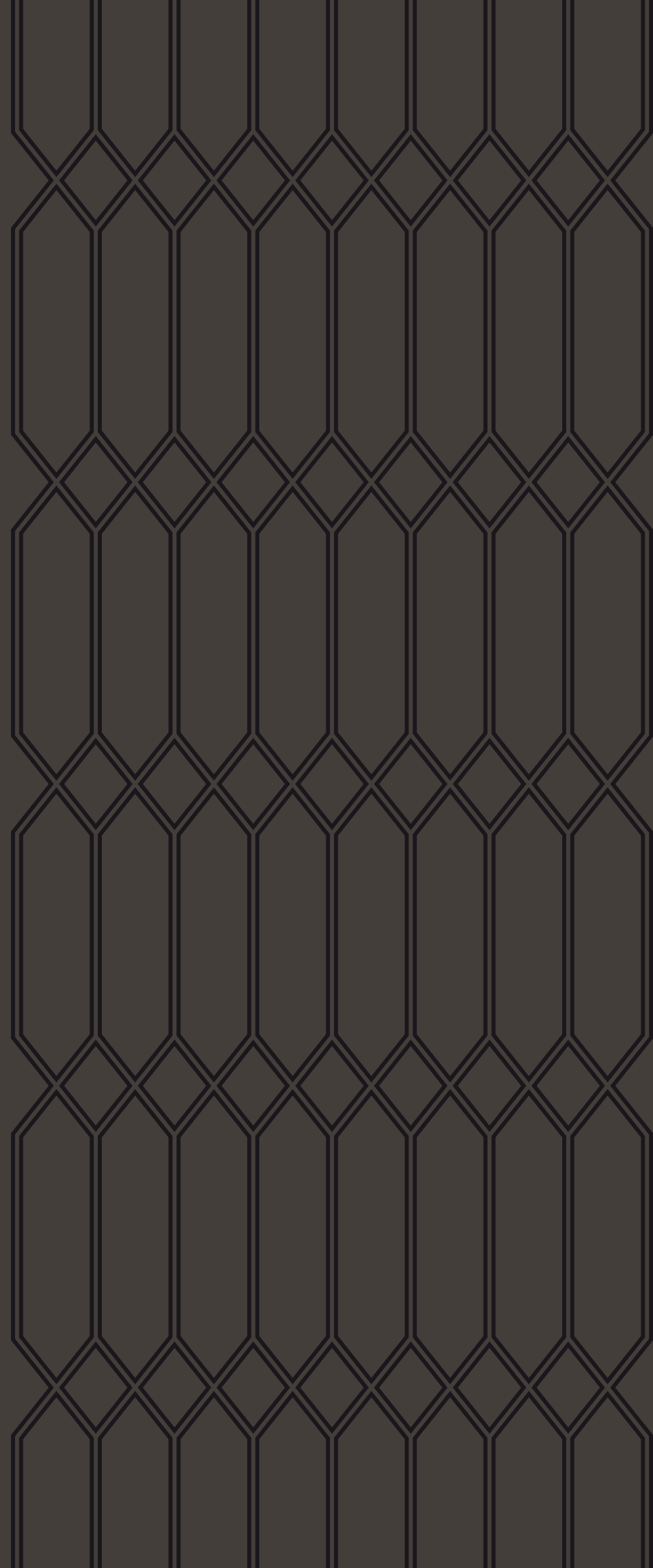

ZB

DRESSING TABLES



EMANUELLE

DRESSING TABLE

Struttura in metallo satinato e multistrati di legno curvato. Disponibile con cassetti e ante in legno laccato. Decorazione su fianchi in pelle ricamata. Specchio molato su supporto metallico.

Satin metal and curved plywood structure. Available with lacquered wooden drawers and doors. Quilted leather side parts. Ground mirror on metallic support.

Каркас из сатинированного металла и изогнутой фанеры. Дверцы и выдвижные ящики из лакированной древесины. Боковые поверхности отделаны стеганой кожей. Настольное зеркало на металлической подставке.

缎纹金属和曲面胶合板结构。漆木抽屉和门。侧面部件为绗缝皮革。金属支架上的卵形镜子。

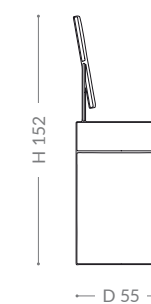
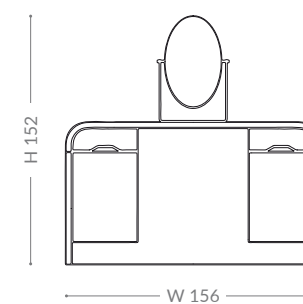

DRESSING TABLES

As picture: Emanuelle dressing table
In price list: Brilliant

Lucidatura/Finishing/Отделка/饰面
94. TAUPE

Parti in metallo/Metal parts/Металлическая фурнитура/金属部件
SATIN GOLD

Materiale/Material/Материал/材料
BZ 906-2007 LEATHER MOKA

KIMBERLY

DRESSING TABLE

Struttura in multistrati di legno curvato, rivestito in pelle. Gambe frontali in legno di faggio con dettagli metallici. Cassetto portagioie con anta decorata in pelle ricamata. Specchio molato.

Curved plywood structure, covered in leather. Beechwood legs with metal details. Jewelry drawer with quilted decoration. Ground mirror.

Каркас из изогнутой фанеры, обтянутый кожей. Ножки из древесины бука с металлическими деталями. Выдвижной ящик для украшений со стеганой отделкой. Настольное зеркало.

曲面胶合板结构，皮革包裹。山毛榉桌腿配有精细金属装饰。珠宝抽屉跟绗缝皮革。卵形镜子。



DRESSING TABLES

As picture: Kimberly dressing table
In price list: Brilliant

Lucidatura/Finishing/Отделка/饰面
50. IVORY

Parti in metallo/Metal parts/Металлическая фурнитура/金属部件
GOLD

Materiale/Material/Материал/材料
BZ 901-332 LEATHER BUTTER

As picture: Kimberly pouf
In price list: Ambition

Pouf/Pouf/Пуф/沙发脚凳
BZ 901-332 LEATHER BUTTER
Lucidatura/Finishing/Отделка/饰面
50. IVORY

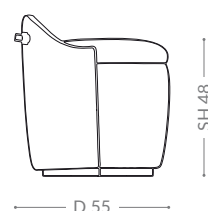
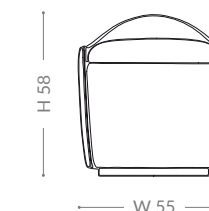
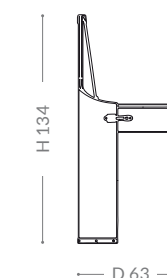
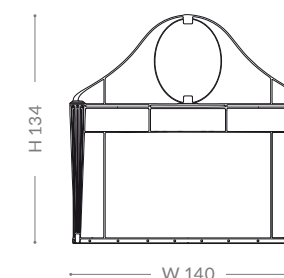

MADemoISELLE

DRESSING TABLE

Struttura in legno massello e multistrati di legno. Disponibile in essenza di noce canaletto. Piedini frontali e maniglie in metallo martellato. Specchio molato su supporto metallico.

Solid wood and plywood structure. Available in canaletto walnut veneer. Hammered metal feet and handles. Ground mirror on metal support.

Каркас из массива дерева и фанеры. Материал: шпон ореха каналетто. Ножки и ручки из кованого металла. Настольное зеркало на подставке из металла.

实木和胶合板结构。卡纳莱托核桃木饰面板，金色锻造金属柜脚和把手。金属支架上的镜子。

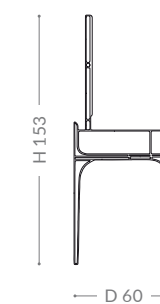
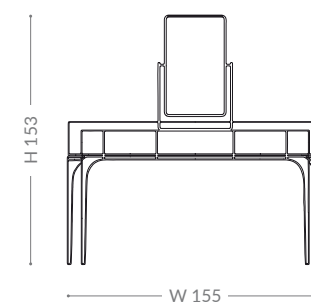

DRESSING TABLES

As picture: Mademoiselle dressing table
In price list: Prime

Lucidatura/Finishing/Отделка/饰面
85. CHOCOLATE MATT
70. CANALETTO WALNUT MATT

Parti in metallo/Metal parts/Металлическая фурнитура/金属部件
HAMMERED GOLD

MADemoISELLE

CHAIR



Struttura in legno massello. Gambe frontali in noce canaletto. Schienale e seduta decorata con ricamo. Imbottitura in poliuretano a quote differenziate.

Solid wood frame. Canaletto walnut front feet. Quilted backrest and seating. Multiple densities polyurethane foam padding.

Каркас из массива дерева. Передние ножки из древесины ореха каналетто. Стеганая спинка и сиденье. Набивка из пенополиуретана на разной плотности.

实木框架。前脚为卡纳莱托核桃木质座椅面和靠背衍缝装饰。内部填充多种密度聚氨酯泡沫垫料。

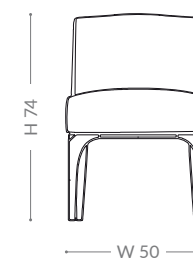

As picture: Mademoiselle chair
In price list: Prestige/Brilliant

Sedia/Chair/Стул/椅子
BZ 216-120 VELVET RHUBARB

Lucidatura/Finishing/Отделка/饰面
94. TAUPE
69. CANALETTO WALNUT

VIVIEN

DRESSING TABLE

Struttura in legno massello e multistrati di legno. Piedini in legno intagliati a mano. Piano disponibile laccato. Maniglie in ottone. Specchio molato in appoggio.

Solid wood and plywood structure. Hand-carved wooden feet. Top available in lacquered wood. Brass handles. Ground mirror.

Каркас из массива дерева и фанеры. Деревянные ножки ручной работы. Материал столешницы: лакированная древесина. Латунные ручки. Настольное зеркало.

实木和胶合板结构。手工雕刻木腿。桌面为漆木，黄铜把手。卵形镜子。



As picture: Moon Walt pouf
In price list: Ambition/Brilliant

Pouf/Pouf/Пуф/沙发脚凳
BZ 901-891 LEATHER IVORY
Lucidatura/Finishing/Отделка/饰面
51. SAND

DRESSING TABLES

As picture: Vivien dressing table
In price list: Brilliant

Lucidatura/Finishing/Отделка/饰面
51. SAND

Parti in metallo/Metal parts/Металлическая фурнитура/金属部件
GOLD

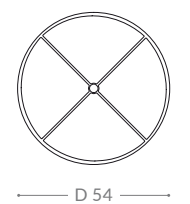
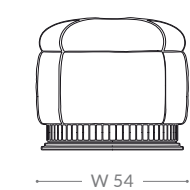
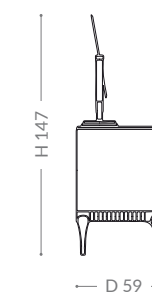
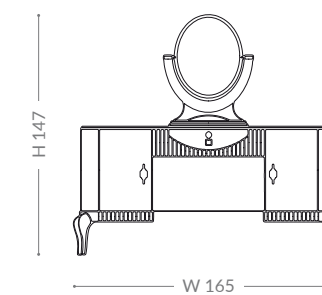

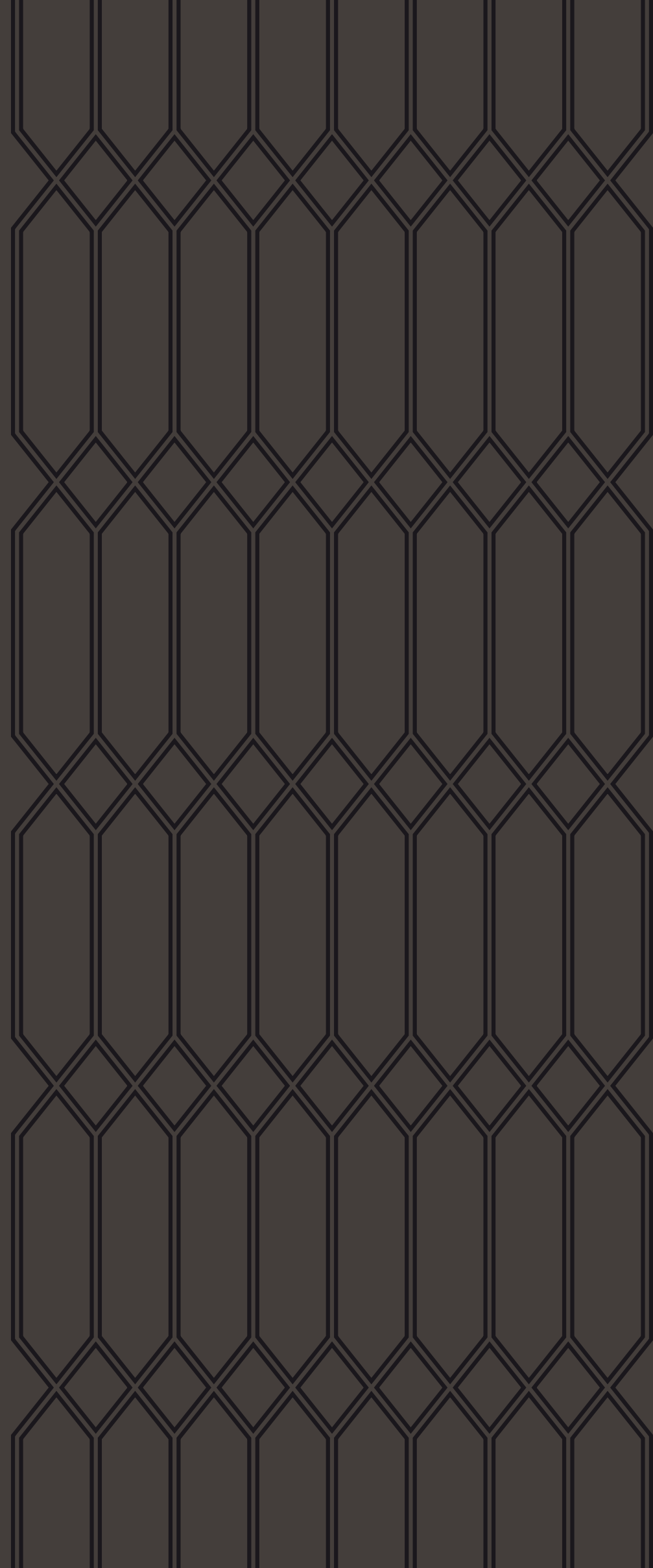

ZB

BENCHES



ADAM

BENCH



BENCHES

As picture: Adam bench
In price list: Ambition

Panca/Bench/Банкетка/长凳
BZ 906-2023 LEATHER CARAMEL

Struttura in legno massello.
Imbottitura in poliuretano
a quote differenziate con
lavorazione *capitoné*.

Solid wood frame. Multiple
densities polyurethane foam
padding with *capitoné*
decoration.

Каркас из массива дерева.
Набивка из пенополиуретана
разной плотности, отделка в
виде каретной стяжки.

实木框架。填充多重密度聚氨酯泡沫，采用分块铆钉装饰。

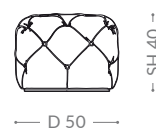
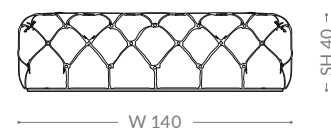

BLANCA

BENCH 100



BENCHES

As picture: Blanca bench 100
In price list: Ambition

Panca/Bench/Банкетка/长凳
BZ 901-702 LEATHER DOVE GREY

Parti in metallo/Metal parts/Металлическая фурнитура/金属部件
SATIN TITANIUM

Struttura in legno massello;
basamento in metallo satinato.
Imbottiture in poliuretano a
quote differenziate.

Solid wood frame; satin metal
base. Multiple densities
polyurethane foam padding.

Каркас из массива дерева,
основа из сатинированного
металла. Набивка из
пенополиуретана разной
плотности.

实木框架，缎面金属底座。内部填充多种密度聚氨酯泡沫垫料。

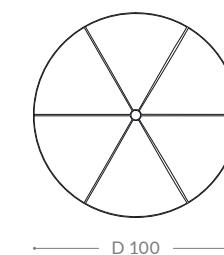
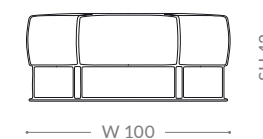

BLANCA

BENCH 160

BENCHES



As picture: Blanca bench 160
In price list: Prime/Brilliant

Panca/Bench/Банкетка/长凳
BZ 200-202 VELVET BURGUNDY

Lucidatura/Finishing/Отделка/饰面
57. CHOCOLATE

Parti in metallo/Metal parts/Металлическая фурнитура/金属部件
SATIN GOLD

Struttura in legno massello; basamento in metallo satinato. Schienale decorato con ricamo. Imbottiture in poliuretano a quote differenziate.

Solid wood frame; satin metal base. Quilted backrest. Multiple densities polyurethane foam padding.

Каркас из массива дерева, основа из сатинового металла. Стеганая спинка. Набивка из пенополиуретана разной плотности.

实木框架，缎面金属底座。绗缝靠背。内部填充多种密度聚氨酯泡沫垫料。

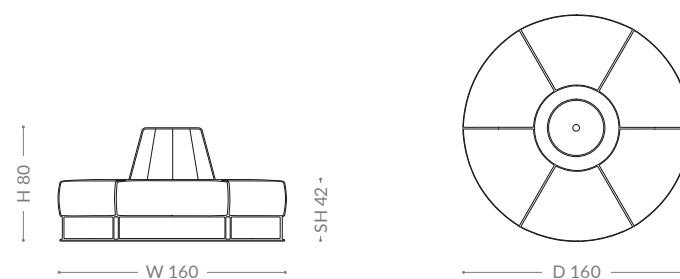

FAYR

BENCH

BENCHES



As picture: Fayr bench
In price list: Ambition/Brilliant

Panca/Bench/Банкетка/长凳
BZ 901-432 LEATHER LIGHT BEIGE

Lucidatura/Finishing/Отделка/饰面
69. CANALETTO WALNUT
54. GREY

Struttura in multistrati di legno curvato. Piedini in noce canaletto. Seduta decorata con ricamo. Imbottiture in poliuretano a quote differenziate.

Curved plywood frame. Canaletto walnut wooden feet. Quilted seating. Multiple densities polyurethane foam padding.

Каркас из изогнутой фанеры. Ножки из древесины ореха каналетто. Стеганое сиденье. Набивка из пенополиуретана разной плотности.

曲面胶合板结构。前脚为卡纳莱托核桃木质绗缝座椅。内部填充多种密度聚氨酯泡沫垫料。

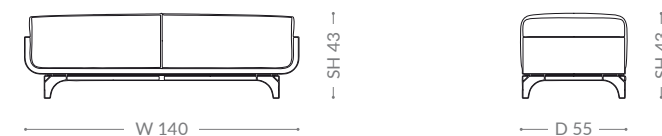

FLY

BENCH



BENCHES

As picture: Fly bench
In price list: Prime/Brilliant

Panca/Bench/Банкетка/长凳
BZ 187-127 VELVET SAND

Parti in metallo/Metal parts/Металлическая фурнитура/金属部件
51. SAND

Struttura in legno massello; basamento in legno di faggio sagomato. Seduta in poliuretano con lavorazione capitonné.

Solid wood frame; shaped beechwood base. Polyurethane foam seating with capitonné decoration.

Каркас из массива дерева, фигурная основа из бука. Сиденье из пенополиуретана украшено каретной стяжкой.

实木框架；山毛榉型材底座。聚氨酯泡沫填充座位，采用分块铆钉装饰。

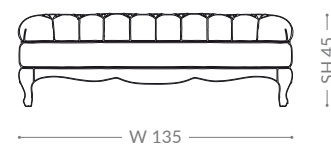

GREY

BENCH



BENCHES

As picture: Grey bench
In price list: Ambition

Panca/Bench/Банкетка/长凳
BZ 905-5230 LEATHER GREY

Lucidatura/Finishing/Отделка/饰面
83. DUST GREY MATT

Struttura in legno massello. Decorata con ricamo. Imbottitura in poliuretano a quote differenziate.

Solid wood frame. Quilted decoration. Multiple densities polyurethane foam padding.

Каркас из массива дерева. Стеганая отделка. Набивка из пенополиуретана разной плотности.

实木框架。绗缝装饰。内部填充多种密度聚氨酯泡沫垫料。

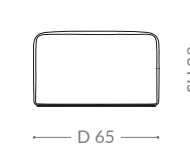
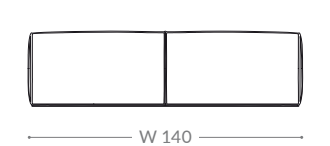

HERMES

BENCH



BENCHES

As picture: Hermes bench
In price list: Ambition/
Brilliant

Panca/Bench/Банкетка/长凳
BZ 901-432 LEATHER LIGHT BEIGE

Lucidatura/Finishing/Отделка/饰面
88. DIAMOND TITANIUM
54. GREY

Parti in metallo/Metal parts/
Металлическая фурнитура/
金属部件
TITANIUM

Struttura in legno massello e multistrati di legno. Seduta in poliuretano decorata con ricamo.

Solid wood and plywood frame. Polyurethane foam seating with quilted decoration.

Каркас выполнен из массива дерева и фанеры. Сиденье из пенополиуретана украшено стеганой отделкой.

实木和胶合板框架。座椅内部填充密度聚氨酯泡沫垫料，绗缝装饰

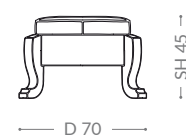

MOON WALT

BENCH



BENCHES

As picture: Moon Walt bench
In price list: Ambition/Brilliant

Panca/Bench/Банкетка/长凳
BZ 901-432 LEATHER LIGHT BEIGE

Lucidatura/Finishing/Отделка/饰面
53. DOVE GREY

Struttura in legno massello; basamento in legno decorato. Parte esterna trapuntata. Imbottitura in poliuretano a quote differenziate.

Solid wood frame; decorated wooden base. Quilted outer body. Multiple densities polyurethane foam padding.

Каркас из массива дерева, деревянная основа с отделкой. Стеганая внешняя часть корпуса. Набивка из пенополиуретана разной плотности.

实木框架；带装饰木制底座。外侧部分绗缝。填充多重密度聚氨酯泡沫。

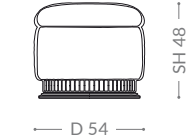
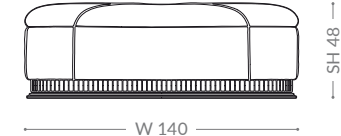

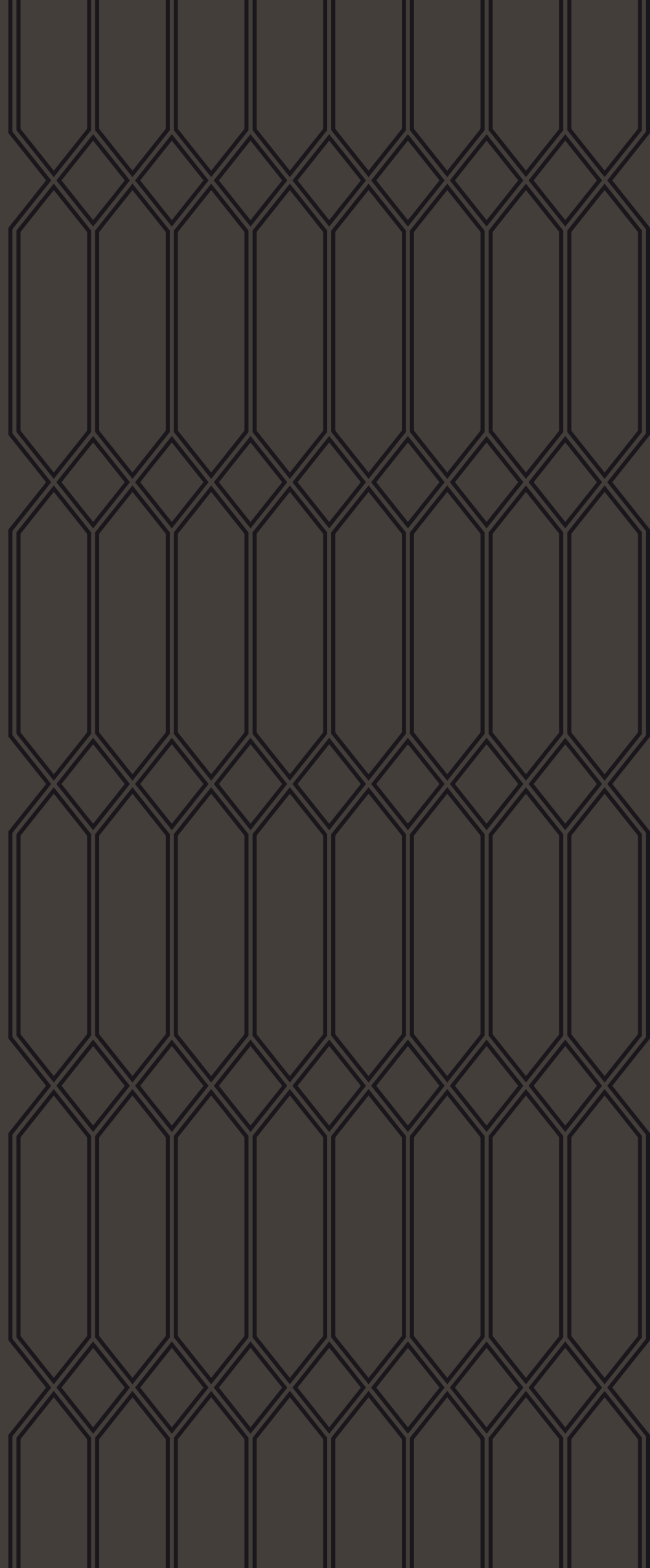

ZB

CONSOLLES



KIMBERLY

CONSOLLE

Struttura in multistrati di legno curvato, rivestito in pelle. Gambe frontali in legno di faggio con dettagli metallici. Cassetto in multistrati di legno decorato in pelle ricamata.

Curved plywood frame, covered in leather. Beechwood legs with metal details. Plywood drawer, quilted leather decorated.

Изогнутая фанерная рама, обтянутая кожей. Ножки из бука с металлическими деталями. Выдвижной ящик из фанеры, отделка стеганой кожей.

曲面胶合板框架，采用皮革包裹。山毛榉桌腿配有精细金属装饰。胶合板抽屉，采用绗缝皮革装饰。

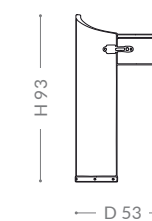
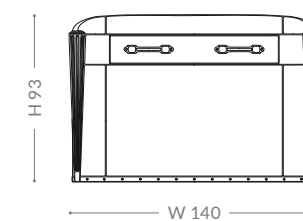

CONSOLLES

As picture: Kimberly console
In price list: Brilliant

Lucidatura/Finishing/Отделка/饰面
94. TAUPE

Parti in metallo/Metal parts/Металлическая фурнитура/金属部件
GOLD

Materiale/Material/Материал/材料
BZ 906-2007 LEATHER MOKA

KIMBERLY

CONSOLLE SMALL



Struttura in multistrati di legno curvato, rivestito in pelle ricamata. Cassetto in multistrati di legno. Dettagli in metallo.

Curved plywood frame, quilted leather covered. Plywood drawer. Metal details.

Изогнутая фанерная рама, обтянутая стеганой кожей. Выдвижной ящик из фанеры. Металлические детали.

曲面胶合板框架，采用绗缝皮革包裹。胶合板抽屉。精细金属配饰。

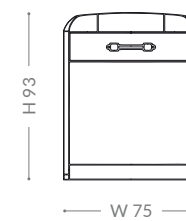

CONSOLLES

As picture: Kimberly console small
In price list: Brilliant

Lucidatura/Finishing/Отделка/饰面
96. BURGUNDY

Parti in metallo/Metal parts/Металлическая фурнитура/金属部件
GOLD

Materiale/Material/Материал/材料
BZ 906-2030 LEATHER BURGUNDY

LUCINDA

CONSOLLE

Struttura in metallo satinato e multistrati di legno curvato. Decorazione su cassetto frontale in pelle ricamata.

Satin metal and curved plywood frame. Quilted leather decoration drawer.

Сатинированный металл и изогнутая фанерная рама. Выдвижной ящик с отделкой стеганой кожей.

缎纹金属和曲面胶合板框架。绗缝皮革装饰抽屉。



CONSOLLES

As picture: Lucinda consolle
In price list: Prime

Lucidatura/Finishing/Отделка/饰面
81. SAND MATT

Parti in metallo/Metal parts/Металлическая фурнитура/金属部件
SATIN TITANIUM

Materiale/Material/Материал/材料
BZ 905-5072 LEATHER CHAMPAGNE

LUCINDA

CONSOLLE

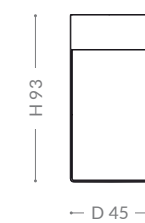
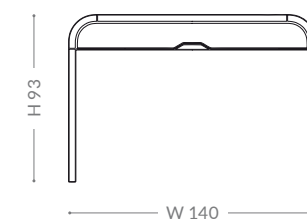

CONSOLLES

As picture: Lucinda console
In price list: Brilliant

Lucidatura/Finishing/Отделка/饰面
57. CHOCOLATE

Parti in metallo/Metal parts/Метал-
лическая фурнитура/金属部件
SATIN GOLD

Materiale/Material/Материал/材料
BZ 906-2003 LEATHER DARK BROWN

RANDOLPH

CONSOLE

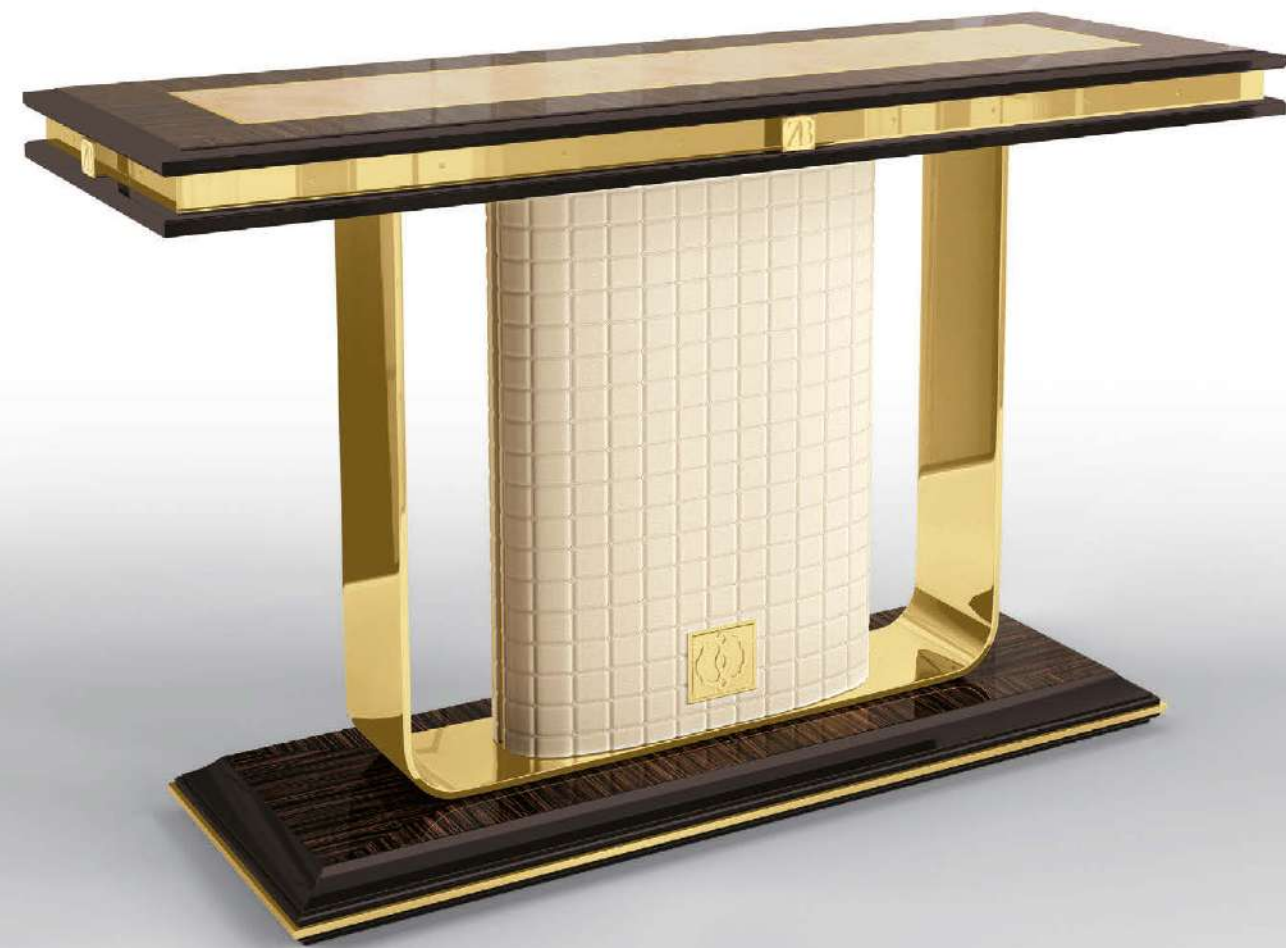

Struttura in legno massello e metallo. Parte centrale in pelle ricamata. Piano disponibile in essenza di ebano makassar con inserto in marmo.

Solid wood and metal frame. Quilted leather decoration. Top available in makassar ebony veneer with marble inlay.

Рама из массива дерева и металла. Отделка стеганой кожей. Доступные материалы столешницы: шпон макассарского эбена с мраморной инкрустацией.

实木与金属框架。绗缝皮革装饰。桌面为大理石镶嵌的望加锡乌木饰面。

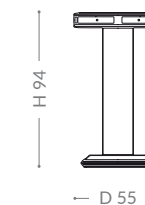
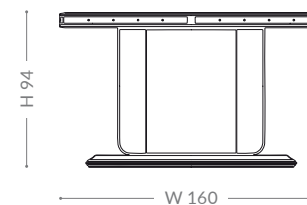

As picture: Randolph console
In price list: Brilliant/Onyx

Lucidatura/Finishing/Отделка/饰面
57. CHOCOLATE
65. MAKASSAR

Parti in metallo/Metal parts/Металлическая фурнитура/金属部件
GOLD

Marmo/Marble/Мрамор/大理石
ONYX HONEY
Materiale/Material/Материал/材料
BZ 901-332 LEATHER BUTTER

SWING

BACKSOFA CONSOLLE

Struttura in legno massello.
Decorazioni in metallo laccate.
Piano disponibile in essenza di
noce canaletto o marmo.

Solid wood frame. Lacquered
metal decorations. Top
available in canaletto wooden
veneer or marble.

Рама из массива дерева.
Украшения из полированного
металла. Доступные
материалы столешницы:
шпон ореха каналетто или
мрамор.

实木框架，点缀漆面金属装
饰。台面可选卡纳莱托木饰板
或大理石

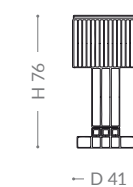
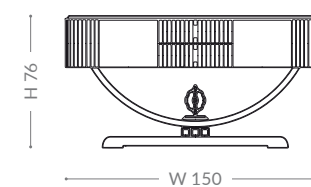

CONSOLLES

As picture: Swing backsofa consolle
In price list: Brilliant

Lucidatura/Finishing/Отделка/饰面
51. SAND
64. CANALETTO WALNUT

Parti in metallo/Metal parts/Метал-
лическая фурнитура/金属部件
61. DIAMOND GOLD

SWING

CONSOLLE LARGE



Struttura in legno massello, multistrati di legno e metallo laccato. Piano disponibile in legno laccato, essenza di noce canaletto o marmo.

Solid wood frame, plywood and lacquered metal. Top available in lacquered wood, canaletto wooden veneer or marble.

Рама из массива дерева, фанеры и полированного металла. Доступные материалы столешницы: лакированная древесина, шпон ореха каналетто или мрамор.

实木框架，胶合板和喷漆金属。桌面可选用漆木、卡纳莱托胡桃木饰面或大理石。

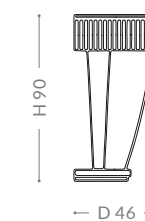
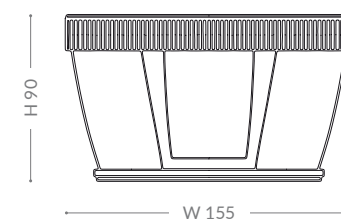

CONSOLLES

As picture: Swing console large
In price list: Brilliant/
Precious stone

Lucidatura/Finishing/Отделка/饰面
51. SAND

Marmo/Marble/Мрамор/大理石
EMPERADOR LIGHT

Parti in metallo/Metal parts/Металлическая фурнитура/金属部件
61. DIAMOND GOLD

SWING

CONSOLLE SMALL

Struttura in legno massello, multistrati di legno e metallo laccato. Piano disponibile in legno laccato, essenza di noce canaletto o marmo.

Solid wood frame, plywood and lacquered metal. Top available in lacquered wood, canaletto wooden veneer or marble.

Рама из массива дерева, фанеры и полированного металла. Доступные материалы столешницы: лакированная древесина, шпон ореха каналетто или мрамор.

实木框架，胶合板和喷漆金属。桌面可选用漆木、卡纳莱托胡桃木饰面或大理石。

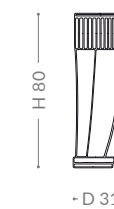
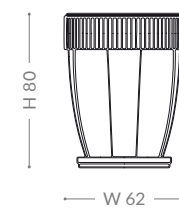

As picture: Swing console small
In price list: Brilliant/Precious stone

Lucidatura/Finishing/Отделка/饰面
58. BLACK

Marmo/Marble/Мрамор/大理石
BLACK&GOLD

WANDA

CONSOLLE



Struttura in legno massello, multistrati di legno e metallo martellato. Piano disponibile in radica di noce.

Solid wood frame, plywood and hammered metal. Top available in canaletto walnut briar root.

Рама из массива дерева, фанеры и кованого металла. Столешница из ореха каналетто и бриара.

实木框架，胶合板和锤纹金属。桌面为卡纳莱托胡桃木石南根。

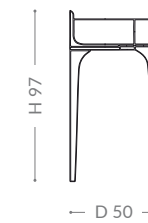
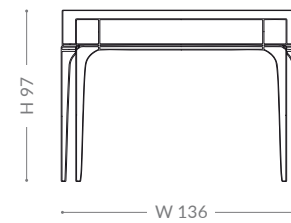

As picture: Wanda consolle
In price list: Brilliant

Lucidatura/Finishing/Отделка/饰面
71. WALNUT BRIAR ROOT
57. CHOCOLATE

Parti in metallo/Metal parts/Металлическая фурнитура/金属部件
HAMMERED GOLD

WANDA

CONSOLLE SMALL

Struttura in legno massello, multistrati di legno e metallo martellato. Piano disponibile in essenza di noce canaletto.

Solid wood frame, plywood and hammered metal. Top available in canaletto wooden veneer.

Рама из массива дерева, фанеры и кованого металла. Деревянная столешница из шпона ореха каналетто.

实木框架，胶合板和锤纹金属。桌面为卡纳莱托实木饰面。

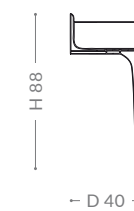
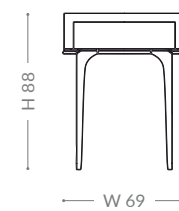

As picture: Wanda consolle small
In price list: Prime

Lucidatura/Finishing/Отделка/饰面
93. WENGÉ MATT
100. GREY MATT

Parti in metallo/Metal parts/Металлическая фурнитура/金属部件
HAMMERED GOLD

CONCORDE

SIDEBOARD



Struttura in legno massello e multistrati di legno. Dettagli maniglia e base in metallo. Piano e ante disponibili in essenza di noce canaletto o ebano makassar.

Solid wood and plywood frame. Metal handle details and base. Top and doors available in canaletto walnut and makassar ebony veneer.

Рама из массива дерева и фанеры. Металлические детали ручек и основа. Доступные материалы столешницы и дверок: шпон ореха каналетто и макаassarского эбена.

实木胶合板框架。金属把手配饰和底座。台面和柜门可选用卡纳莱托胡桃木饰面和望加锡乌木饰面。

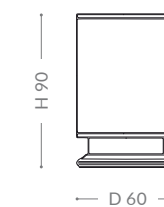
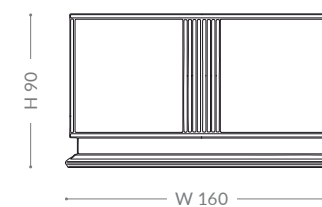

As picture: Concorde sideboard
In price list: Brilliant

Lucidatura/Finishing/Отделка/饰面
53. DOVE GREY
63. WHITENED CANALETTO WALNUT

Parti in metallo/Metal parts/Металлическая фурнитура/金属部件
GOLD

CONCORDE

SIDEBOARD WIDE



Struttura in legno massello e multistrati di legno. Dettagli maniglia e base in metallo. Piano e ante disponibili in essenza di noce canaletto o ebano makassar.

Solid wood and plywood frame. Metal handle details and base. Top and doors available in canaletto walnut and makassar ebony veneer.

Рама из массива дерева и фанеры. Металлические детали ручек и основа. Доступные материалы столешницы и дверок: шпон ореха каналетто и макаassarского эбена.

实木胶合板框架。金属把手配饰和底座。台面和柜门可选用卡纳莱托胡桃木饰面和望加锡乌木饰面。

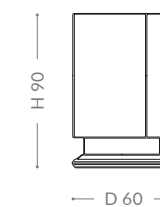
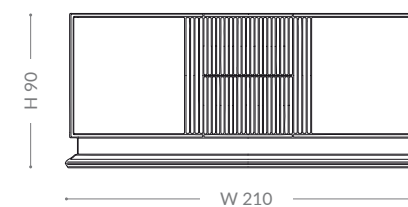

SIDEBOARDS

As picture: Concorde sideboard wide
In price list: Brilliant

Lucidatura/Finishing/Отделка/饰面
65. MAKASSAR
57. CHOCOLATE

Parti in metallo/Metal parts/Металлическая фурнитура/金属部件
GOLD

DEANNA

SIDEBOARD 9 DRAWERS

Struttura in legno massello e multistrati di legno. Disponibile in essenza di noce canaletto. Piedini frontali e maniglie in metallo satinato.

Solid wood and plywood frame. Available in canaletto walnut veneer. Satin metal frontal feet and handles.

Рама из массива дерева и фанеры. Доступный материал: шпон ореха каналетто. Передние ножки и ручки из сатинированного металла.

实木胶合板框架，卡纳莱托胡桃木饰面。正面柜脚和把手采用缎纹金属。

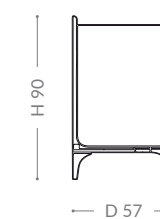
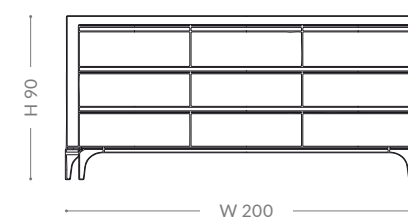

As picture: Deanna sideboard
9 drawers
In price list: Prime

Lucidatura/Finishing/Отделка/饰面
70. CANALETTO WALNUT MATT
85. CHOCOLATE MATT

Parti in metallo/Metal parts/Металлическая фурнитура/金属部件
SATIN TITANIUM

DEANNA

SIDEBOARD 3 DRAWERS

Struttura in legno massello e multistrati di legno. Disponibile in essenza di noce canaletto. Piedini frontali e maniglie in metallo satinato.

Solid wood and plywood frame. Available in canaletto walnut veneer. Satin metal frontal feet and handles.

Рама из массива дерева и фанеры. Доступный материал: шпон ореха каналетто. Передние ножки и ручки из сатинированного металла.

实木胶合板框架，卡纳莱托胡桃木饰面。正面柜脚和把手采用缎纹金属。

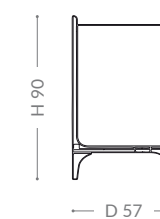
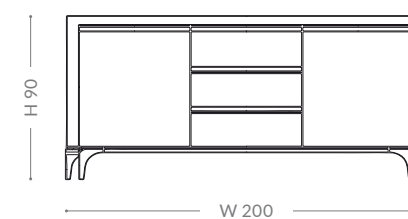

As picture: Deanna sideboard
3 drawers
In price list: Brilliant

Lucidatura/Finishing/Отделка/饰面
98. WENGÉ
53. DOVE GREY

Parti in metallo/Metal parts/Металлическая фурнитура/金属部件
SATIN GOLD

DUKE

SIDEBOARD



Struttura in legno massello e multistrati di legno. Piedini in legno intagliati a mano. Piano disponibile in essenza di noce canaletto o marmo. Maniglie in ottone.

Solid wood and plywood frame. Hand-carved feet. Top available in canaletto walnut veneer or marble. Brass handles.

Рама из массива дерева и фанеры. Ножки ручной работы. Доступные материалы столешницы: шпон ореха каналетто или мрамор. Латунные ручки.

实木胶合板框架。柜脚为手工雕刻。餐柜台面可选用卡纳莱托胡桃木饰面或大理石。黄铜把手。

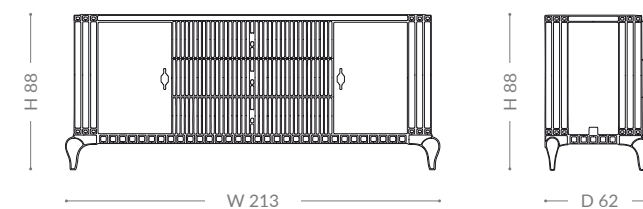

SIDEBOARDS

As picture: Duke sideboard
In price list: Brilliant/
Precious stone

Lucidatura/Finishing/Отделка/饰面
51. SAND
64. CANALETTO WALNUT

Marmo/Marble/Мрамор/大理石
EMPERADOR LIGHT

Parti in metallo/Metal parts/Металлическая фурнитура/金属部件
GOLD

FIORILE

SIDEBOARD



Struttura in metallo satinato e multistrati di legno curvato. Disponibile in legno laccato. Decorazione su cassetti e ante frontali in pelle ricamata.

Satin metal and curved plywood frame. Available in lacquered wood. Quilted leather drawers and doors.

Сатинированный металл и изогнутая фанерная рама. Доступный материал: лакированная древесина. Выдвижные ящики и дверцы, обшитые стеганой кожей.

缎纹金属和曲面胶合板框架。漆木质地。抽屉和柜门采用绗缝皮革。

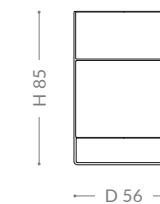
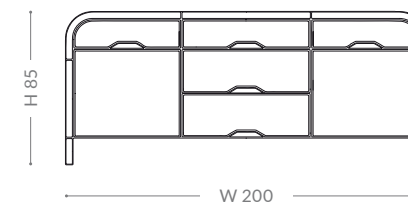

SIDEBOARDS

As picture: Fiorile sideboard
In price list: Brilliant

Lucidatura/Finishing/Отделка/饰面
54. GREY

Parti in metallo/Metal parts/Металлическая фурнитура/金属部件
SATIN GOLD

Materiale/Material/Материал/材料
BZ 906-2006 LEATHER TAUPE

GLENN

SIDEBOARD HIGH



Struttura in legno massello e multistrati di legno. Piano e ante disponibili in essenza di ebano makassar o erable grigio. Fronte cassetti decorati in pelle ricamata. Maniglie in ottone.

Solid wood and plywood frame. Top and doors available in makassar ebony or grey erable veneer. Quilted leather drawers. Brass handles.

Рама из массива дерева и фанеры. Доступный материал столешницы и дверок: шпон макассарского эбена или шпон серого клена. Выдвижные ящики из стеганой кожи. Латунные ручки.

实木胶合板框架。台面和柜门可选用孟加锡乌木饰面或灰雀眼木饰面。绗缝皮革抽屉。黄铜把手。

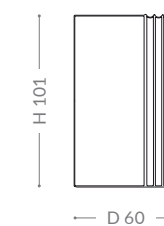
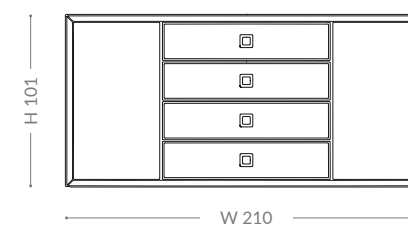

SIDEBOARDS

As picture: Glenn sideboard high
In price list: Brilliant

Lucidatura/Finishing/Отделка/饰面
65. MAKASSAR
57. CHOCOLATE

Parti in metallo/Metal parts/Металлическая фурнитура/金属部件
GOLD

Materiale/Material/Материал/材料
BZ 901-891 LEATHER IVORY

GLENN

SIDEBOARD LOW



Struttura in legno massello e multistrati di legno. Piano e ante disponibili in essenza di ebano makassar o erable grigio. Fronte cassetti decorati in pelle ricamata. Maniglie in ottone.

Solid wood and plywood frame. Top and doors available in makassar ebony or grey erable veneer. Quilted leather drawers. Brass handles.

Рама из массива дерева и фанеры. Доступный материал столешницы и дверок: шпон макассарского эбена или шпон серого клена. Выдвижные ящики из стеганой кожи. Латунные ручки.

实木胶合板框架。台面和柜门可选用孟加锡乌木饰面或灰雀眼木饰面。绗缝皮革抽屉。黄铜把手。

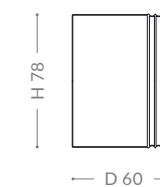
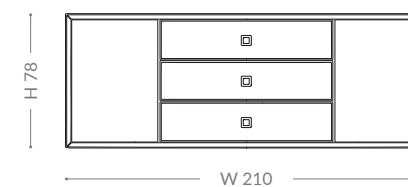

SIDEBOARDS

As picture: Glenn sideboard low
In price list: Brilliant

Lucidatura/Finishing/Отделка/饰面
53. DOVE GREY
74. ERABLE GREY

Parti in metallo/Metal parts/Металлическая фурнитура/金属部件
TITANIUM

Materiale/Material/Материал/材料
BZ 901-432 LEATHER LIGHT BEIGE

REMINGTON

SIDEBOARD

Struttura in legno massello, multistrati di legno e MDF. Piano in legno laccato. Parte laterale e cassetti decorati in pelle ricamata. Dettagli e maniglie in ottone. Colonne decorative in legno con fresature verticali.

Solid wood, plywood and MDF frame. Lacquered wooden top. Quilted leather side parts and drawers. Brass handles and details. Wooden columns with fluted decorations.

Рама из массива дерева, фанеры и МДФ. Столешница из лакированной древесины. Боковые части и выдвижные ящики из стеганой кожи. Латунные ручки и детали. Деревянные опоры с рифлеными украшениями.

实木、胶合板、以及中密度纤维板（MDF）框架。漆木桌面。侧面部件和抽屉采用绗缝皮革。黄铜把手和配饰。木制柜体带有凹槽装饰。

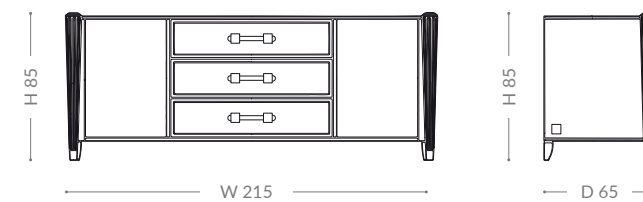
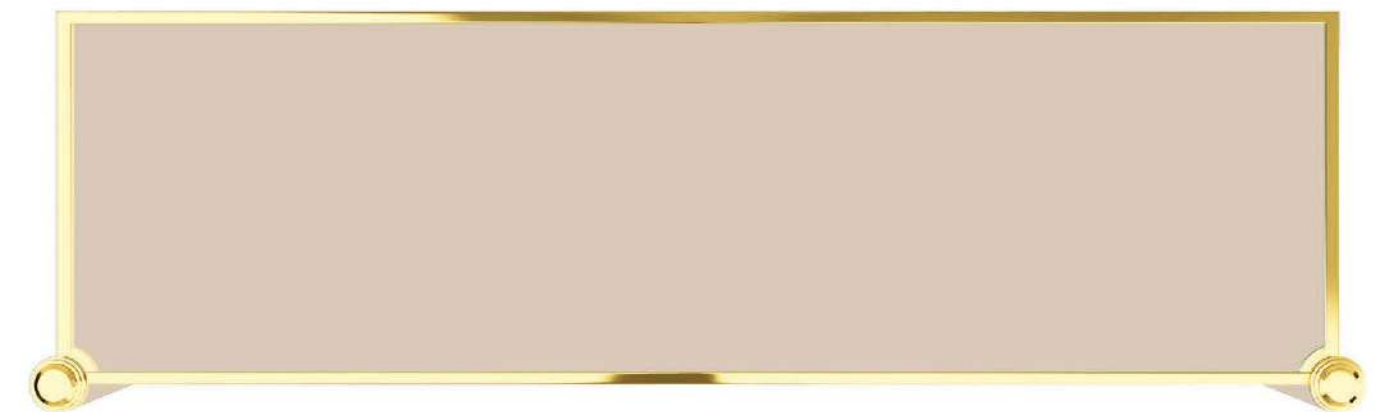

SIDEBOARDS

As picture: Remington sideboard
In price list: Brilliant

Lucidatura/Finishing/Отделка/饰面
51. SAND

Parti in metallo/Metal parts/Металлическая фурнитура/金属部件
GOLD

Materiale/Material/Материал/材料
BZ 901-891 LEATHER IVORY

CONCORDE

TV FRAME

Struttura in legno massello e multistrati di legno. Cornice frontale disponibile in essenza di erable grigio, ebano makassar o noce canaletto. Parte interna decorata in pelle ricamata.

Solid wood and plywood structure. Front profile available in grey erable, makassar ebony or canaletto walnut veneer. Quilted leather inner body.

Каркас из массива дерева и фанеры. Доступные материалы: шпон серого клена, макассарского эбена или ореха каналетто. Внутренние поверхности отделана стеганой кожей.

实木和胶合板结构。前侧柜体可选用灰雀眼木饰面、孟加锡乌木饰面或卡纳莱托胡桃木饰面。内部框架采用绗缝皮革。

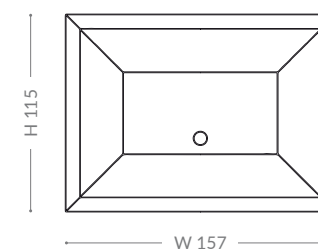
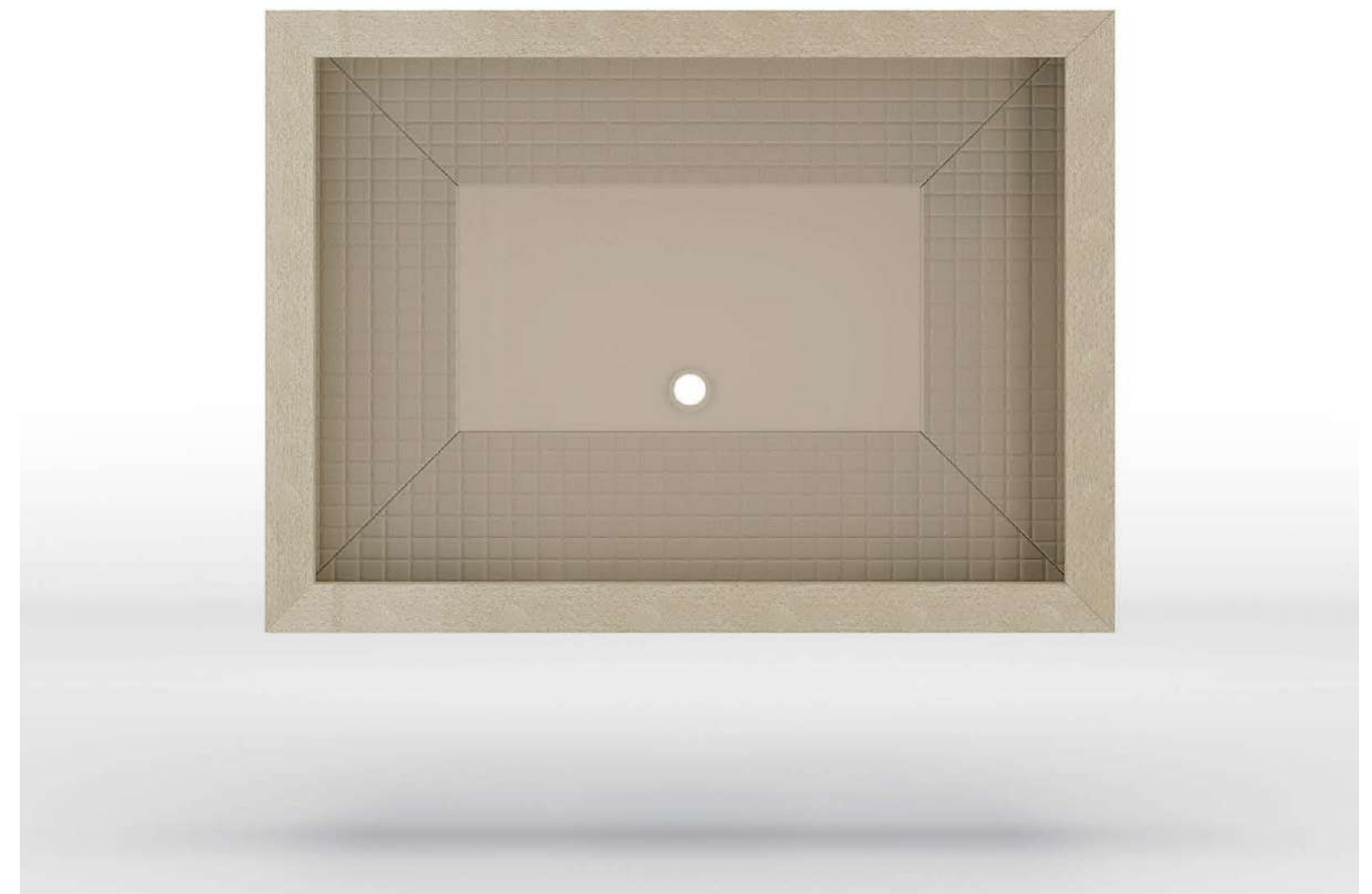
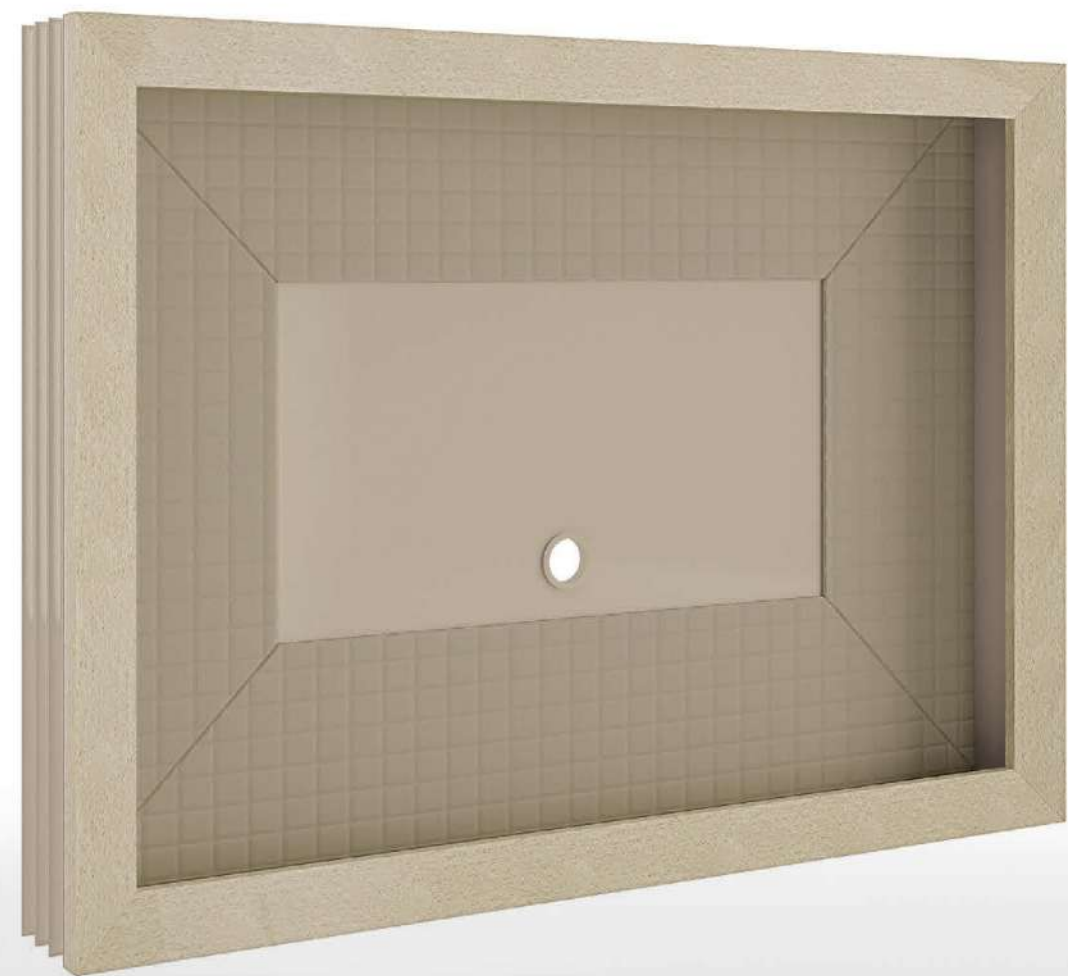

As picture: Concorde Tv frame
In price list: Brilliant

Lucidatura/Finishing/Отделка/饰面
53. DOVE GREY
74. ERABLE GREY

Materiale/Material/Материал/材料
BZ 901-702 LEATHER DOVE GREY

CONCORDE

TV CABINET

Struttura in legno massello e multistrati di legno. Cornice frontale e cassetti disponibili in essenza di erable grigio, ebano makassar o noce canaletto. Dettagli base e maniglie in ottone.

Solid wood and plywood structure. Front profile and drawers available in grey erable, makassar ebony or canaletto walnut veneer. Handles and base details in brass.

Каркас из массива дерева и фанеры. Доступные материалы: шпон серого клена, макассарского эбена или ореха каналетто. Латунные ручки и опорные детали.

实木和胶合板结构。前侧柜体和抽屉可选用灰雀眼木饰面、孟加锡乌木饰面或卡纳莱托胡桃木饰面。把手和底座配饰采用黄铜。



T
V
U
N
I
T
S

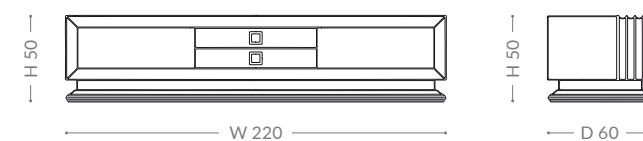

As picture: Concorde Tv cabinet
In price list: Brilliant

Lucidatura/Finishing/Отделка/饰面
53. DOVE GREY
74. ERABLE GREY

Parti in metallo/Metal parts/Металлическая фурнитура/金属部件
TITANIUM

DUCA

TV FRAME

Cornice in noce canaletto massello. Pannello interno in multistrati di legno, decorato in pelle ricamata. Parte centrale in legno laccato.

Canaletto walnut solid outer frame. Plywood back panel, decorated with quilted leather; central part in lacquered finishing.

Каркас из массива ореха каналетто. Задняя панель из фанеры, отделанная стеганой кожей, лакированная средняя часть.

卡纳莱托胡桃木实木外框。胶合板背板，绗缝皮革装饰；中部喷漆加工。

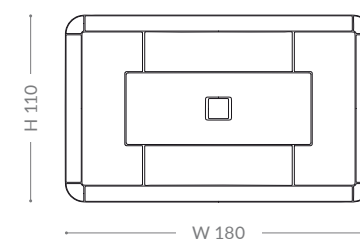
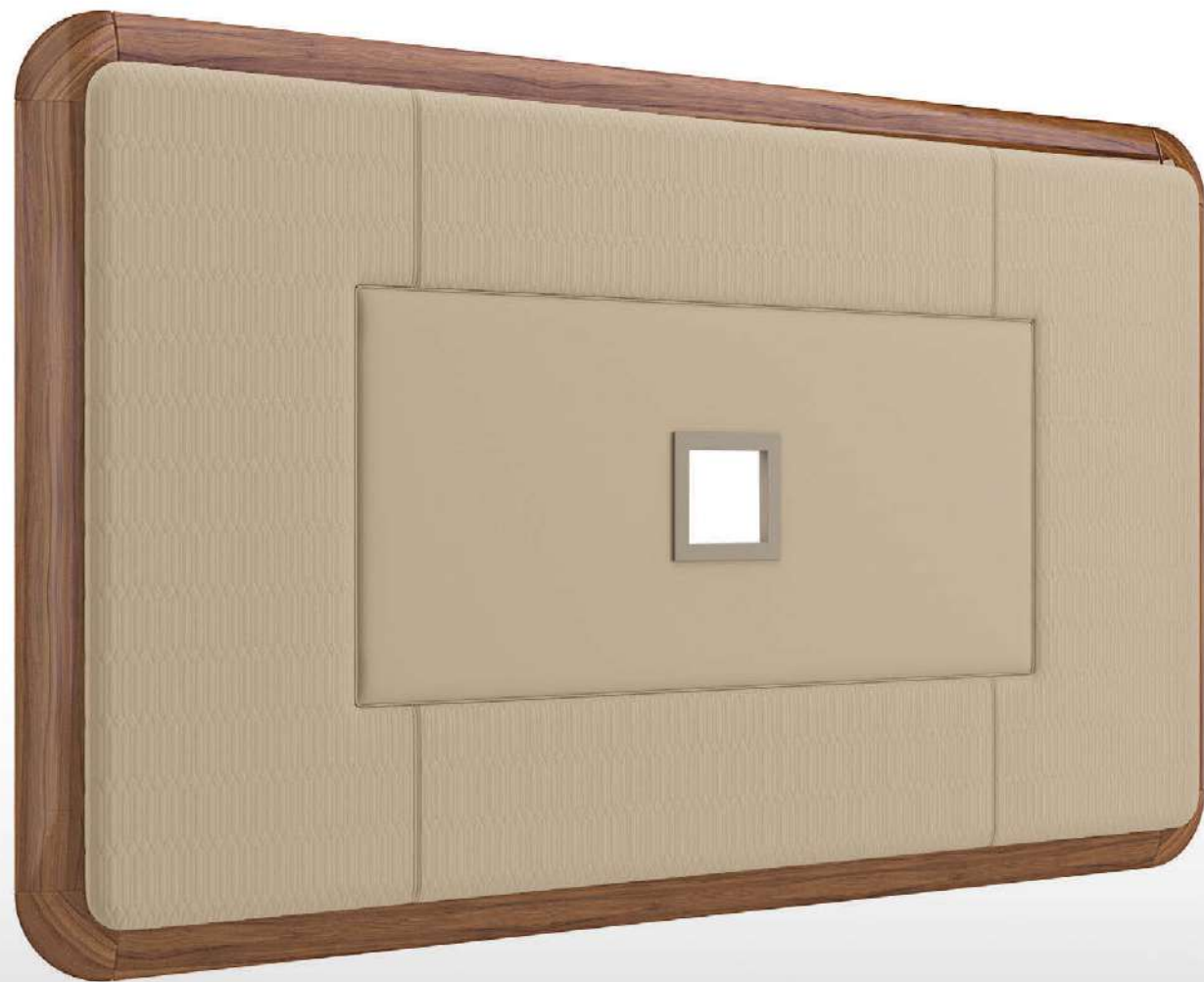

T
V
U
N
I
T
S

As picture: Duca Tv frame
In price list: Brilliant

Lucidatura/Finishing/Отделка/饰面
69. CANALETTO WALNUT
100. GREY MATT

Materiale/Material/Материал/材料
BZ 906-2005 LEATHER OASI

DUCA

TV CABINET

Struttura in legno massello e multistrati di legno. Struttura superiore disponibile in essenza di noce canaletto. Piedini frontali e maniglie in metallo satinato. Ripiano in cristallo color bronzo.

Solid wood and plywood structure. Upper structure available in canaletto walnut veneer. Satin metal front feet and handles. Crystal shelf, bronze colour.

Каркас из массива дерева и фанеры. Верхняя часть каркаса из шпона ореха каналетто. Передние ножки и ручки из satinированного металла. Хрустальной полкой, бронзового цвета.

实木和胶合板结构。上部结构为卡纳莱托胡桃木饰面。缎纹金属前柜脚和把手。水晶陈列架，青铜色。



T
V
U
N
I
T
S

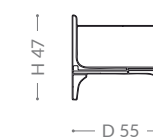
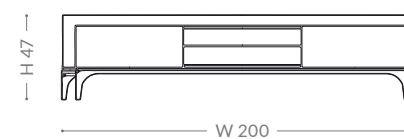

As picture: Duca Tv cabinet
In price list: Brilliant

Lucidatura/Finishing/Отделка/饰面
54. GREY
69. CANALETTO WALNUT

Parti in metallo/Metal parts/Металлическая фурнитура/金属部件
SATIN GOLD

Vetro/Glass/Стекло/изделие/玻璃
BRONZE

DUKE

TV FRAME

Cornice in legno massello, pannello in multistrati di legno. Parte interna con decorazione a traforo e tessuto.

Solid wood structure and plywood back panel. Internal framing with fretwork decoration and fabric.

Каркас из массива дерева и задняя панель из фанеры. Внутренняя поверхность украшена резной отделкой и текстилем.

实木结构和胶合板背板。内部框架采用浮雕装饰和织物装饰。

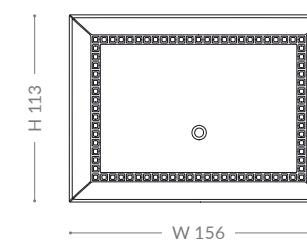
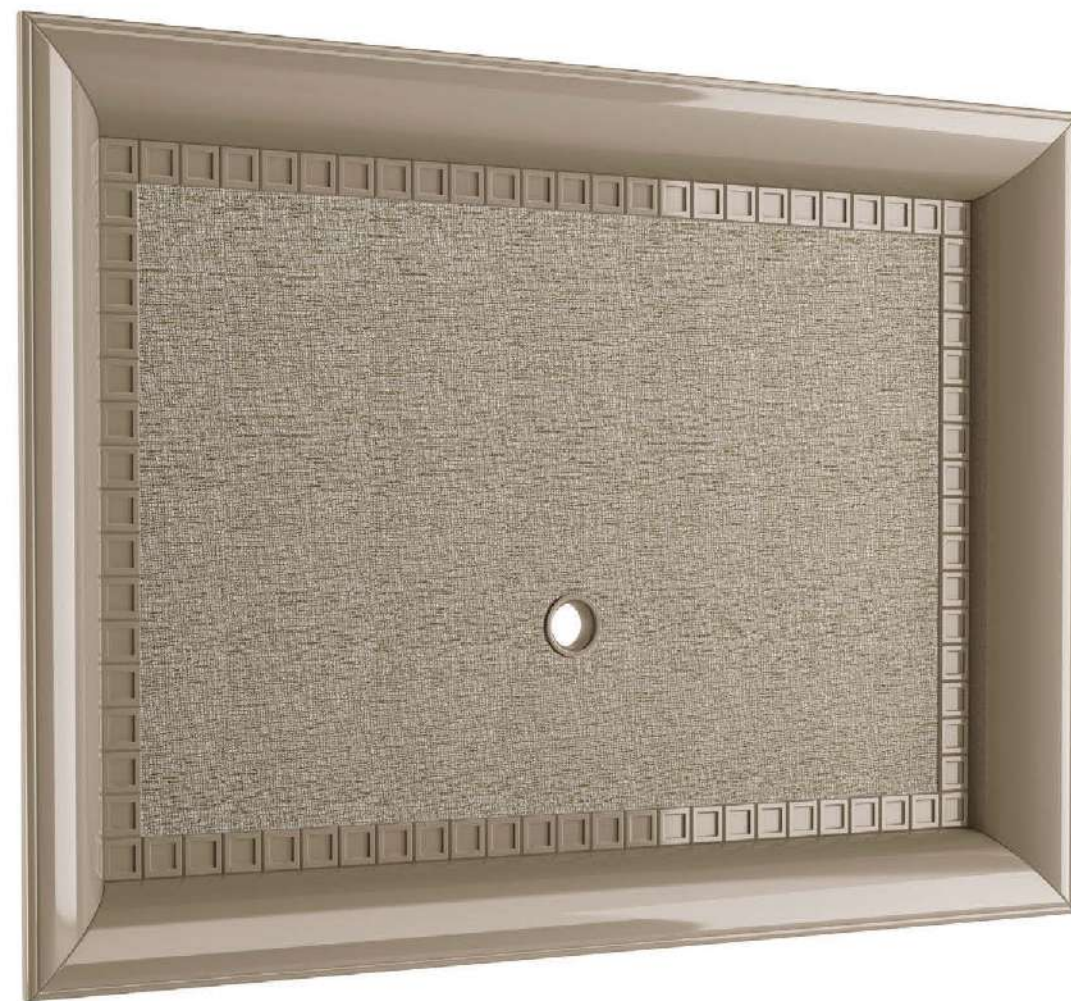

As picture: Duke Tv frame
In price list: Brilliant

Lucidatura/Finishing/Отделка/饰面
54. GREY

Materiale/Material/Материал/材料
BZ 126-51 UNITO GREY/PEARL

DUKE

TV CABINET



Struttura in legno massello e multistrati di legno. Piedini in legno intagliati a mano. Piano disponibile in essenza di noce canaletto o marmo. Maniglie in ottone.

Solid wood and plywood structure. Hand-carved wooden legs. Top available in canaletto walnut veneer or marble. Brass handles.

Каркас из массива дерева и фанеры. Резные деревянные ножки ручной работы. Доступные материалы столешницы: шпон ореха каналетто или мрамор. Латунные ручки.

实木和胶合板结构。木制柜脚采用手工雕刻。电视柜台面可选用卡纳莱托胡桃木饰面或大理石。黄铜把手。

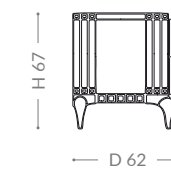
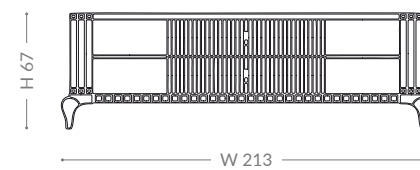

T
V
U
N
I
T
S

As picture: Duke Tv cabinet
In price list: Brilliant

Lucidatura/Finishing/Отделка/饰面
54. GREY
64. CANALETTO WALNUT

Parti in metallo/Metal parts/Металлическая фурнитура/金属部件
88. DIAMOND TITANIUM

FIORILE

TV CABINET

Struttura in metallo satinato e multistrati di legno curvato. Disponibile in legno laccato. Decorazione su cassetti frontali in pelle ricamata.

Satin metal and curved plywood structure. Available in lacquered wood. Quilted leather front drawers.

Каркас из сатинового металла и изогнутой фанеры. Материал: лакированная древесина. Фасады выдвижных ящиков отделаны стеганой кожей.

缎纹金属和曲面胶合板结构。漆木质地。前部抽屉采用绗缝皮革。



T
V
U
N
I
T
S

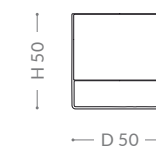
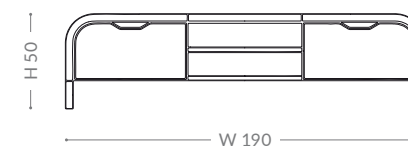

As picture: Fiorile Tv cabinet
In price list: Brilliant

Lucidatura/Finishing/Отделка/饰面
94. TAUPE

Parti in metallo/Metal parts/Металлическая фурнитура/金属部件
SATIN GOLD

Materiale/Material/Материал/材料
BZ 906-2007 LEATHER MOKA

REMINGTON

TV FRAME



Struttura in multistrati di legno. Profili perimetrali in metallo. Cornice decorata in pelle ricamata. Parte interna disponibile in essenza di ebano makassar.

Plywood structure. Metal profiles. Quilted leather framework. Back panel available in makassar ebony veneer.

Каркас из фанеры. Металлические профили. Рамка из стеганой кожи. Задняя панель из шпона макассарского эбена.

胶合板结构。金属柜体。绗缝皮革框架。孟加锡乌木饰面背板。

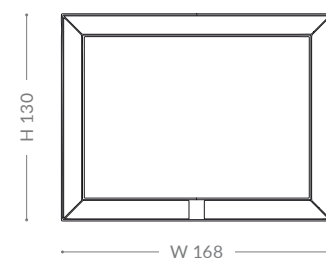
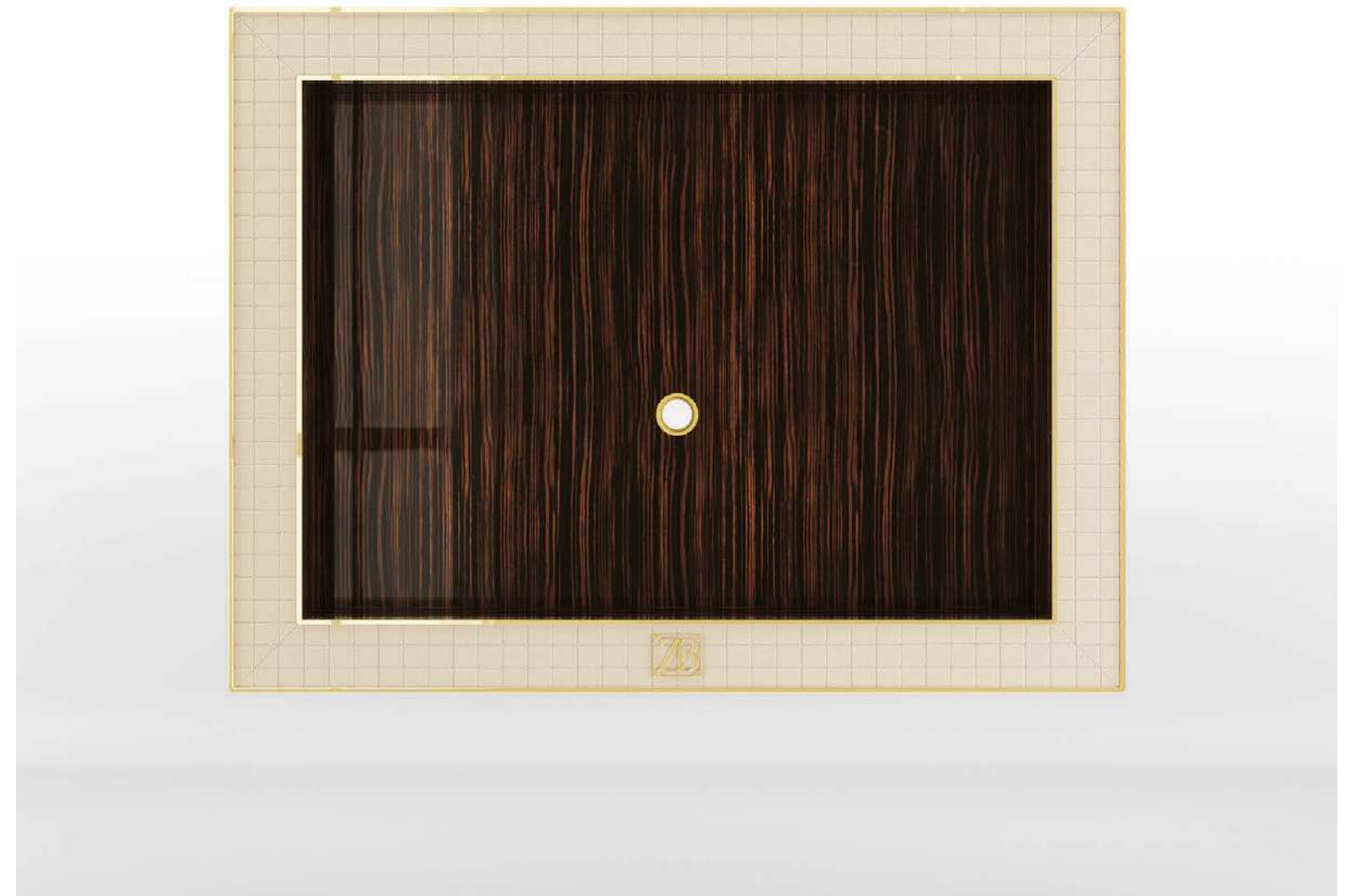

T
V
U
N
I
T
S

As picture: Remington Tv frame
In price list: Brilliant

Lucidatura/Finishing/Отделка/饰面
65. MAKASSAR

Parti in metallo/Metal parts/Металлическая фурнитура/金属部件
GOLD

Materiale/Material/Материал/材料
BZ 901-332 LEATHER BUTTER

REMINGTON

TV CABINET



Struttura in legno massello, multistrati di legno e MDF. Piano, fianco e cassetti decorati in pelle ricamata. Profili e maniglie in metallo. Colonne decorative in legno con dettagli in ottone.

Solid wood, plywood and MDF structure. Quilted leather outer structure and drawers. Metal handles and profiles. Wooden columns, with brass decoration.

Каркас из массива дерева, фанеры и МДФ. Наружные поверхности и выдвижные ящики отделаны стеганой кожей. Металлические ручки и профили. Деревянные ножки-колонны с латунной отделкой.

实木、胶合板和中密度纤维板结构。外部结构和抽屉采用绗缝皮革。金属把手和柜体。木制支柱带有黄铜装饰。

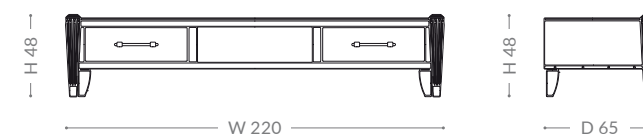

T
V
U
N
I
T
S

As picture: Remington Tv cabinet
In price list: Brilliant

Lucidatura/Finishing/Отделка/饰面
50. IVORY

Parti in metallo/Metal parts/Металлическая фурнитура/金属部件
GOLD

Materiale/Material/Материал/材料
BZ 901-332 LEATHER BUTTER

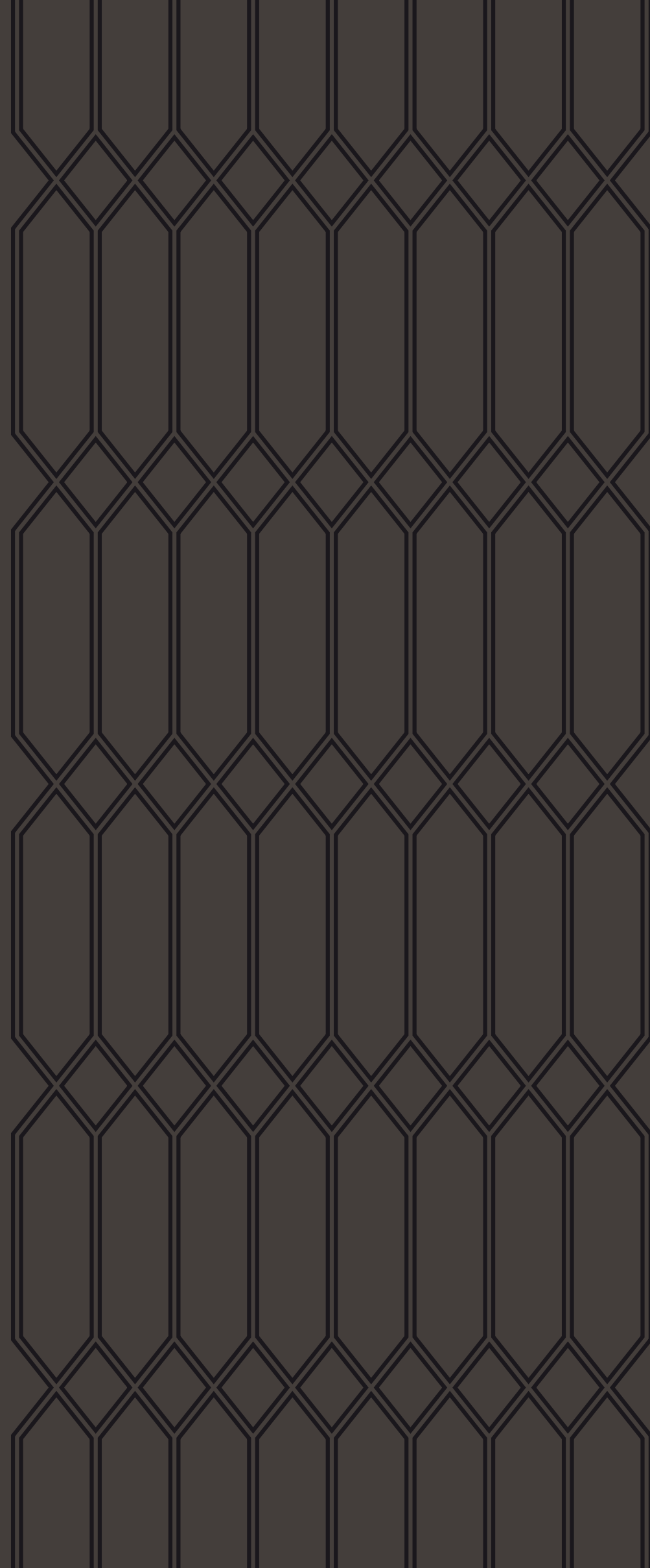

ZB

DISPLAY
CABINETS



CONCORDE

DISPLAY CABINET



As picture: Concorde display cabinet
In price list: Brilliant

Lucidatura/Finishing/Отделка/饰面
53. DOVE GREY
74. ERABLE GREY

Parti in metallo/Metal parts/Металлическая фурнитура/金属部件
TITANIUM

Struttura in legno massello e multistrati di legno. Disponibile in essenza di erable grigio, ebano makassar o noce canaletto. Ante in legno massello e vetro extrawhite. Maniglie in metallo. Parte interna con ripiani in cristallo e schienale a specchio bronzo.

Solid wood and plywood structure. Available in grey erable, makassar ebony or canaletto walnut veneer. Solid wood doors, extrawhite glass. Metal handles. Internally fitted with crystal shelves and bronze mirror back panel.

Каркас из массива дерева и фанеры. Доступные материалы: шпон серого клена, макассарского эбена или ореха канаletto. Двери из массива дерева и бесцветного просветленного стекла. Металлические ручки. Внутри установлены хрустальные полки и зеркальная задняя панель бронзового оттенка.

实木和胶合板结构。可选灰雀眼木饰面、孟加锡乌木饰面或卡纳莱托胡桃木饰面。实木柜门，外配白色玻璃。金属把手。内部配有水晶陈列架和铜镜背板。

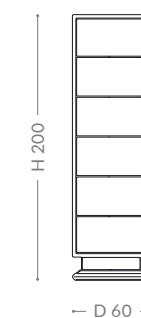
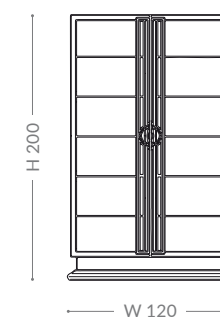

ESTELLE

DISPLAY CABINET

Struttura in metallo e legno.
Parte esterna decorata in
pelle ricamata. Parte interna
laccata, ripiani in cristallo
illuminati a LED e schienale in
pelle ricamata. Ante in vetro
temperato e maniglia in ottone.

Metal and wooden structure.
Quilted leather outer body.
Lacquered inner body, LED
lighting crystal shelves, quilted
leather back panel. Tempered
glass doors with brass handles.

Каркас из металла и дерева.
Выполнена наружная отделка
стеганой кожей. Лакирован-
ная внутренняя поверхность,
хрустальные полки со свето-
диодной подсветкой, задняя
панель отделана стеганой
кожей. Двери из закаленного
стекла с латунными ручками.

金属木制结构。外部为绗缝皮
革。内部喷漆，LED 照明水晶
陈列架，绗缝皮革背板。钢化
玻璃门带有黄铜把手。

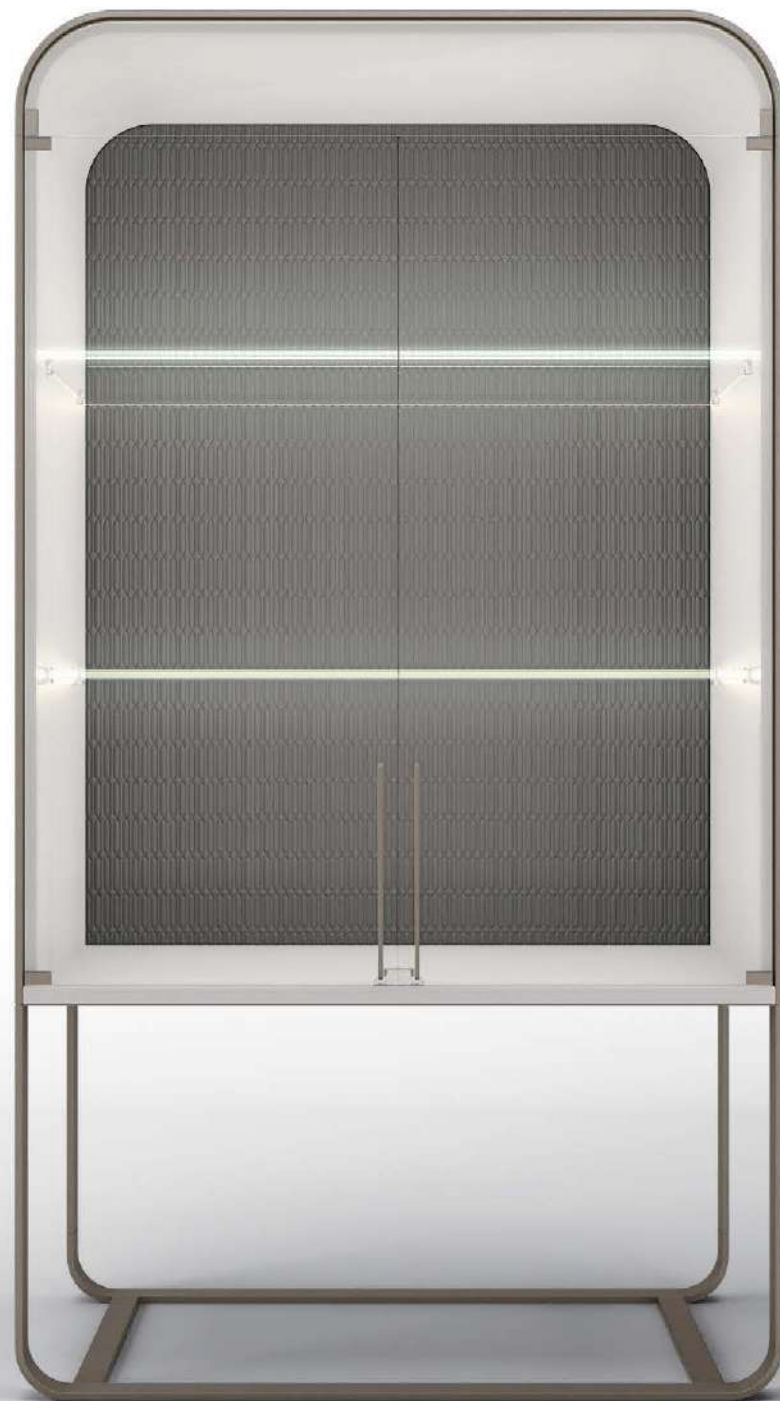

ESTELLE

DISPLAY CABINET



DISPLAY CABINETS

As picture: Estelle display cabinet
In price list: Prime

Lucidatura/Finishing/Отделка/饰面
85. CHOCOLATE MATT

Parti in metallo/Metal parts/Металлическая фурнитура/金属部件
SATIN GOLD

Materiale/Material/Материал/材料
BZ 906-2003 LEATHER DARK BROWN

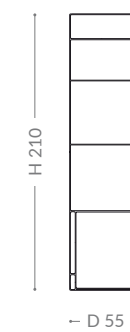
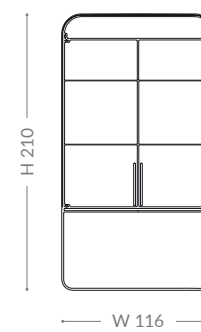

FRITZ

DISPLAY CABINET



Struttura in legno massello; gambe in legno intagliate a mano. Parte interna con ripiani in vetro; schienale in tessuto. Ante in vetro temperato con maniglie in ottone.

Solid wood structure; hand-carved legs. Internally fitted with glass shelves and fabric back panel. Tempered glass doors with brass handles.

Каркас из массива дерева; резные ножки ручной работы. Внутри установлены стеклянные полки, задняя панель отделана текстилем. Двери из закаленного стекла с латунными ручками.

实木结构；柜脚采用手工雕刻。内部配有玻璃陈列架和织物背板。钢化玻璃门带有黄铜把手。

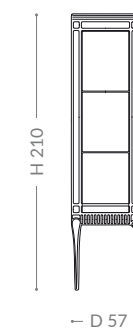
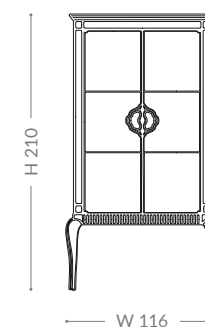

DISPLAY CABINETS

As picture: Fritz display cabinet
In price list: Prime

Lucidatura/Finishing/Отделка/饰面
55. COFFEE

Parti in metallo/Metal parts/Металлическая фурнитура/金属部件
GOLD

Materiale/Material/Материал/材料
BZ 184-901 PALMA BEIGE/IVORY

KIMBERLY

DISPLAY CABINET



Struttura in multistrati di legno curvato, rivestito in pelle. Gambe frontali in legno di faggio e dettagli metallici. Ante in vetro intagliato, ripiani in vetro. Schienale in essenza di ebano makassar e illuminazione LED. Maniglie in metallo.

Curved plywood structure, covered in leather. Beechwood legs with metal details. Carved glass doors; glass shelves. Makassar ebony veneer back panel and LED lighting. Metal handles.

Каркас из изогнутой фанеры, обтянутый кожей. Ножки из бука с металлическими деталями. Резные стеклянные дверцы, стеклянные полки. Задняя панель изготовлена из макаassarского эбенового дерева и светодиодная подсветка. Латунными ручками.

曲面胶合板结构，皮革覆盖。山毛榉柜角点缀金属装饰细节。雕花玻璃门，玻璃置物架。望加錫乌木背板，LED 照明。金属把手。

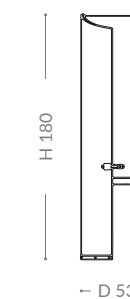
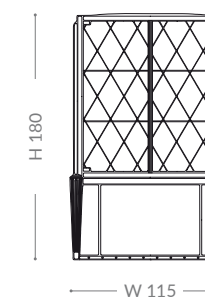

DISPLAY CABINETS

As picture: Kimberly display cabinet
In price list: Brilliant

Lucidatura/Finishing/Отделка/饰面
51. SAND

Parti in metallo/Metal parts/Металлическая фурнитура/金属部件
GOLD

Materiale/Material/Материал/材料
BZ 901-891 LEATHER IVORY

VENUS

DISPLAY CABINET



Struttura in noce canaletto massello. Ripiani interni in vetro, schienale in pelle ricamata. Ante in vetro curvato e noce canaletto, maniglie in metallo satinato.

Solid canaletto walnut wood structure. Internally fitted with glass shelves, quilted leather back panel. Doors in curved glass and canaletto walnut wood. Satin metal handles.

Каркас из массива ореха каналетто. Внутри установлены стеклянные полки, задняя панель отделана стеганой кожей. Двери выполнены из гнутого стекла и древесины ореха каналетто. Ручки из сатинированного металла.

卡纳莱托胡桃木实木结构。内部配有玻璃陈列架，绗缝皮革背板。柜门采用曲面玻璃和卡纳莱托胡桃木。缎纹金属把手。

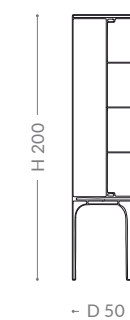
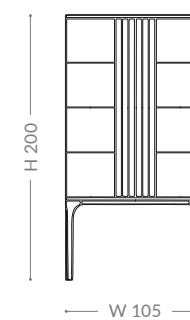

DISPLAY CABINETS

As picture: Venus display cabinet
In price list: Prime

Lucidatura/Finishing/Отделка/饰面
70. CANALETTO WALNUT MATT

Parti in metallo/Metal parts/Металлическая фурнитура/金属部件
SATIN GOLD

Materiale/Material/Материал/材料
BZ 906-2005 LEATHER OASI

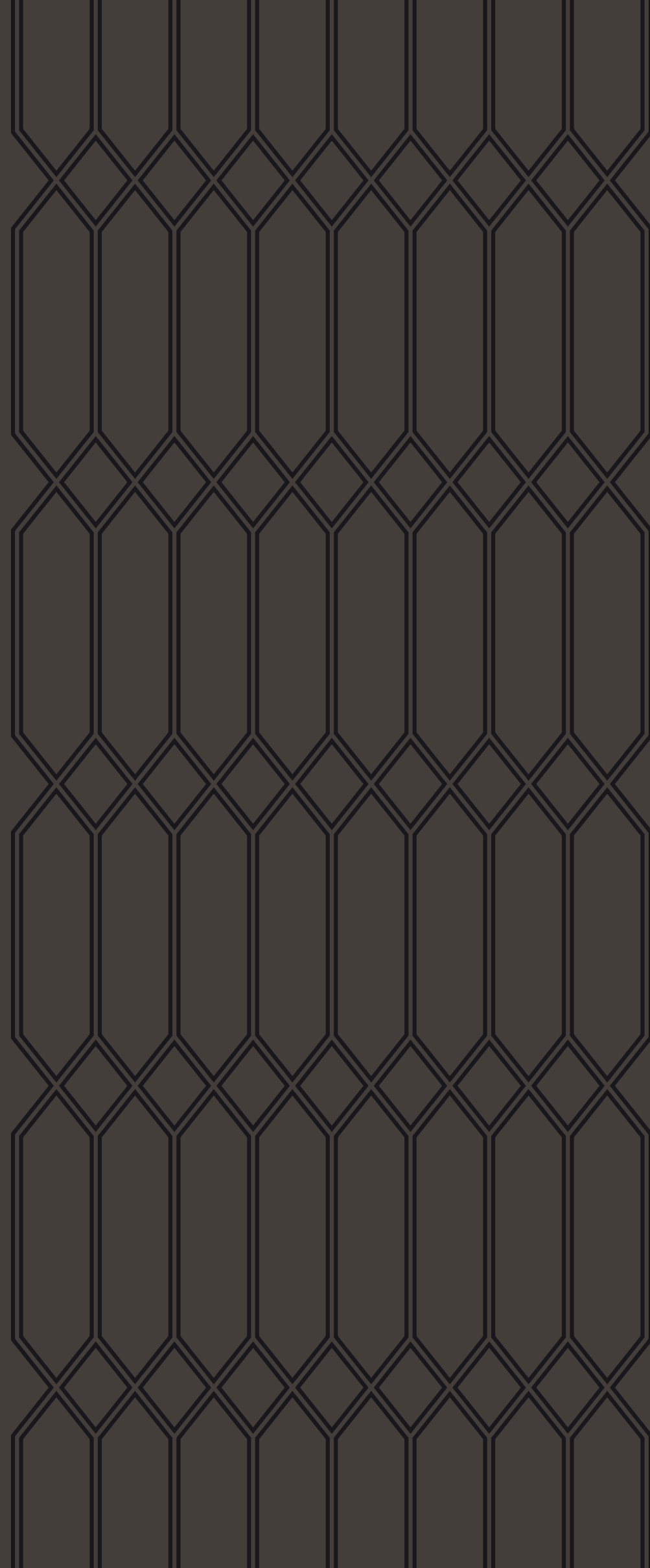

ZB

BOOKSHELVES



CLARK

BOOKSHELF



Struttura in legno massello, multistrati di legno e MDF. Schienale con decorazione in bassorilievo. Maniglie in ottone.

Solid wood, plywood and MDF structure. Back panel with low relief decoration. Brass handles.

Каркас из массива дерева, фанеры и МДФ. Задняя панель украшена барельефом. Латунные ручки.

实木、胶合板和中密度纤维板结构。背板采用浅浮雕装饰。黄铜把手。

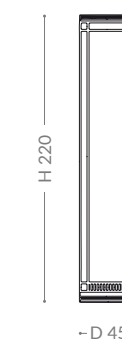
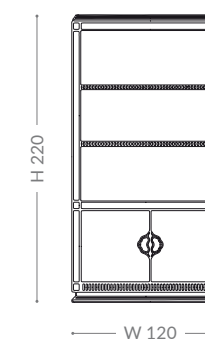

As picture: Clark bookshelf
In price list: Brilliant

Lucidatura/Finishing/Отделка/饰面
50. IVORY

Parti in metallo/Metal parts/Металлическая фурнитура/金属部件
GOLD

DAFNE

BOOKSHELF

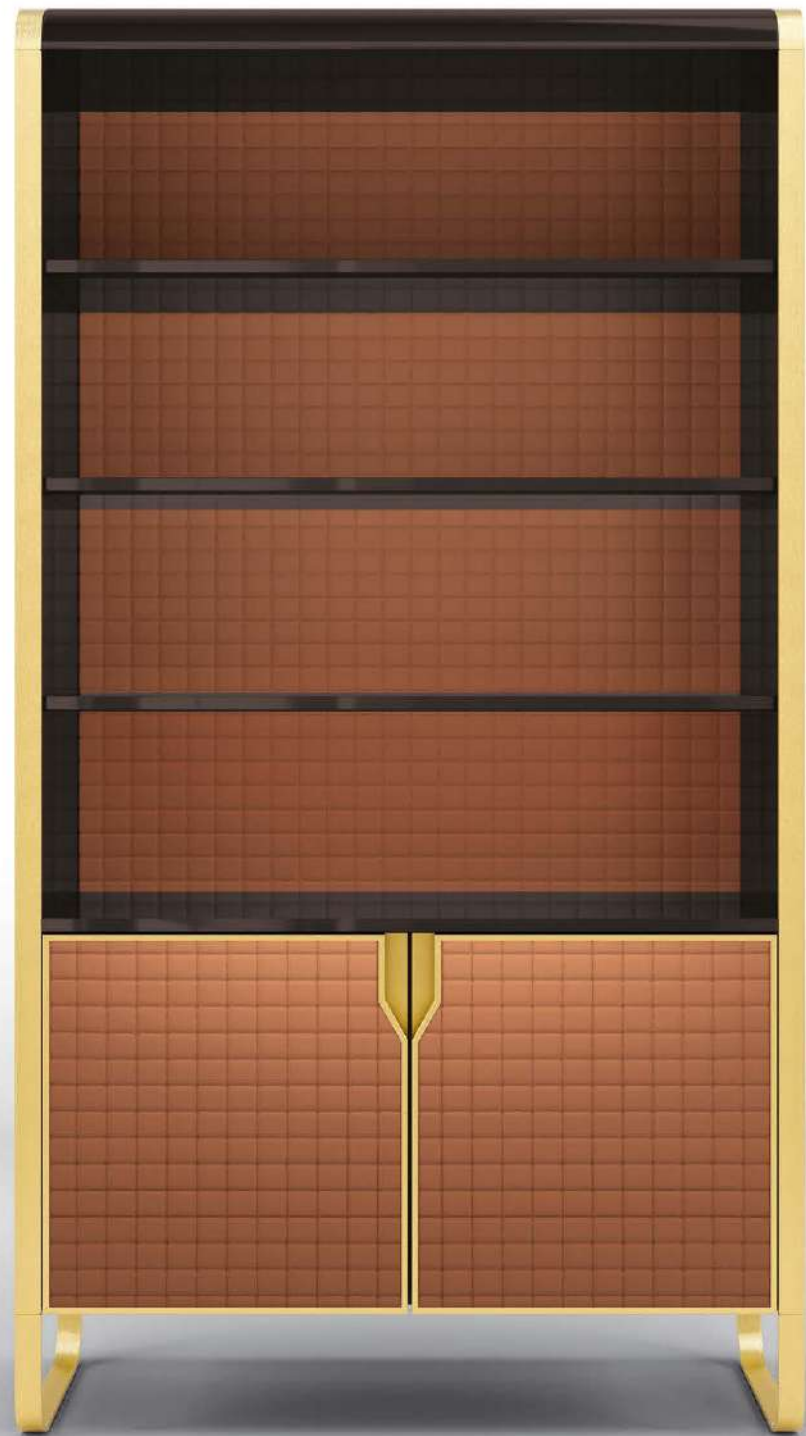

Struttura in metallo satinato, multistrati di legno e MDF. Parte interna e ante decorate in pelle ricamata. Parte esterna e ripiani in legno laccato.

Satin metal, plywood and MDF structure. Quilted leather inner body and doors. Lacquered wooden outer structure and shelves.

Каркас из сатинированного металла, фанеры и МДФ. Внутренние поверхности и двери из стеганой кожи. Внешние поверхности и полки из лакированной древесины.

缎纹金属、胶合板和中密度纤维板结构。书架内部和书架门采用绗缝皮革。外部结构和陈列架采用漆木。

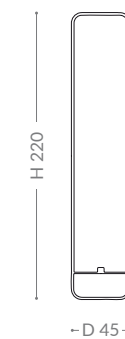
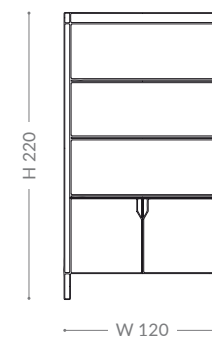

BOOKSHELVES

As picture: Dafne bookshelf
In price list: Brilliant

Lucidatura/Finishing/Отделка/饰面
57. CHOCOLATE

Parti in metallo/Metal parts/Металлическая фурнитура/金属部件
SATIN GOLD

Materiale/Material/Материал/材料
BZ 905-5103 LEATHER LOBSTER

JADE

BOOKSHELF

BOOKSHELVES



Struttura in legno massello, multistrati di legno e MDF. Parte posteriore decorata in pelle ricamata. Ripiani con dettagli in metallo.

Solid wood, plywood and MDF structure. Quilted leather back panel. Shelves with metal details.

Каркас из массива дерева, фанеры и МДФ. Задняя панель отделана стеганой кожей. Полки с металлическими деталями.

实木、胶合板和中密度纤维板结构。绗缝皮革背板。陈列架带有金属配饰。

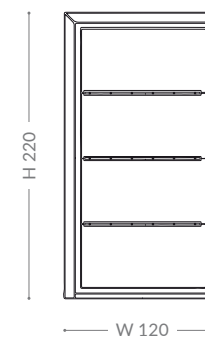

As picture: Jade bookshelf
In price list: Brilliant

Lucidatura/Finishing/Отделка/饰面
57. CHOCOLATE

Parti in metallo/Metal parts/Металлическая фурнитура/金属部件
GOLD

Materiale/Material/Материал/材料
BZ 905-5072 LEATHER CHAMPAGNE

SIRIO

BOOKSHELF



Struttura in legno massello, multistrati di legno e MDF. Cornice perimetrale disponibile in essenza di eucalipto, noce canaletto o ebano makassar. Parte interna in legno laccato con profili in metallo. Schienale interno in alcantara. Decorazione centrale in vetro retroverniciato e logo Bruno Zampa.

Solid wood, plywood and MDF structure. Frame available in eucalyptus, canaletto walnut or makassar ebony veneer. Lacquered wooden inner structure, with metal profiles. Alcantara back panel. Back-painted glass central decoration, with Bruno Zampa logo.

Каркас из массива дерева, фанеры и МДФ. Доступные материалы рамы: шпон эвкалипта, ореха каналетто или макаassarского эбена. Внутренний каркас из лакированной древесины с металлическим профилем. Задняя панель отделана алькантарой. Декоративный элемент в центре из окрашенного с тыльной стороны стекла с логотипом Bruno Zampa.

实木、胶合板和中密度纤维板结构。框架可选用桉木饰面、卡纳莱托胡桃木饰面或孟加锡乌木饰面。内部结构采用漆木，带有金属型材。阿尔坎塔拉人造皮背板。中部采用带有 Bruno Zampa 品牌标志的背面彩绘玻璃装饰。

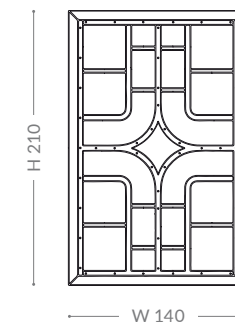

As picture: Sirio bookshelf
In price list: Brilliant

Lucidatura/Finishing/Отделка/饰面
68. EUCALYPTUS FRISÉ
101. COFFEE MATT

Vetro/Glass/
Стеклоное изделие/玻璃
51. SAND

Parti in metallo/Metal parts/Металлическая фурнитура/金属部件
TITANIUM
Materiale/Material/Материал/材料
BZ 186-077 IVORY

CONCORDE

WARDROBE CABINET



Struttura in legno massello e multistrati di legno. Disponibile in essenza di noce canaletto o ebano makassar. Dettagli e maniglie in metallo. Parte interna suddivisa in appenderia con portaombrelli (schienale a specchio e luce a LED), portascarpe estraibili, cassetto portaogetti e portaborse.

Solid wood and plywood structure. Available in canaletto walnut or makassar ebony veneer. Metal handles and details. Internally fitted with hanger rod and umbrella stand (LED lighting mirror back panel), pull-out shoe organizer, drawer and bags organizer.

Каркас из массива дерева и фанеры. Доступные материалы: шпон ореха каналетто или макаassarского эбена. Металлические ручки и детали. Внутри установлены штанга для одежды и подставка для зонтов (зеркальная задняя панель со светодиодной подсветкой), а также выдвижной органайзер для обуви, выдвижной ящик и органайзер для сумок.

实木和胶合板结构。可选用卡纳莱托胡桃木饰面或孟加锡乌木饰面。金属把手及配饰。内部配有吊杆和伞架（LED 照明镜面背板）、推拉式鞋架、抽屉以及收纳包。

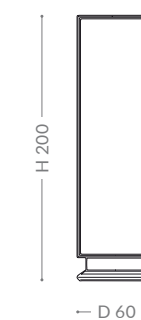
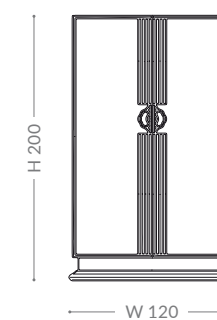

As picture: Concorde wardrobe cabinet
In price list: Brilliant

Lucidatura/Finishing/Отделка/饰面
64. CANALETTO WALNUT
54. GREY

Parti in metallo/Metal parts/Металлическая фурнитура/金属部件
TITANIUM

CONCORDE

WINE CABINET



Struttura in legno massello e multistrati di legno. Disponibile in essenza di noce canaletto o ebano makassar. Dettagli e maniglie in metallo. Parte interna suddivisa in portabottiglie estraibili, cassetto per accessori, vano portabottiglie (schienale a specchio e luce a LED) e vani per oggetti decorativi.

Solid wood and plywood structure. Available in canaletto walnut or makassar ebony veneer. Metal handles and details. Internally fitted with pull-out bottle holder, accessories drawer, bottle compartment (LED lighting mirror back panel) and decorative objects compartments.

Каркас из массива дерева и фанеры. Доступные материалы: шпон ореха каналетто или макаassarского эбена. Металлические ручки и детали. Внутри оборудованы выдвижная полка для бутылок, ящик для принадлежностей, отделение для бутылок (зеркальная задняя панель со светодиодной подсветкой) и отделение для предметов декора.

实木和胶合板结构。可选用卡纳莱托胡桃木饰面和或孟加锡乌木饰面。金属把手及配饰。内部配有推拉式瓶架、收纳抽屉、瓶罐收纳架（LED 照明镜面背板）、以及装饰物品摆放架。

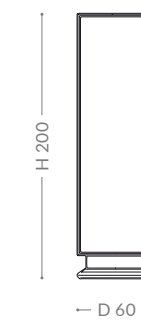
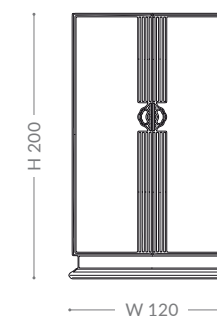

As picture: Concorde wine cabinet
In price list: Brilliant

Lucidatura/Finishing/Отделка/饰面
65. MAKASSAR
57. CHOCOLATE

Parti in metallo/Metal parts/Металлическая фурнитура/金属部件
GOLD

DEDALO

MODULAR SYSTEM

Sistema modulare di elementi per comporre mobili adatti ai più svariati ambienti e concept d'arredo. Di seguito presentiamo alcuni esempi delle infinite possibilità di composizione.

DESCRIZIONE TECNICA

Struttura in legno massello e multistrati di legno. Parte esterna disponibile in legno laccato o essenza di noce canaletto. Parte interna disponibile in legno laccato. Schienale rivestito in alcantara ricamata. Ripiani in cristallo color bronzo. Ante in legno decorate in pelle ricamata o in vetro color bronzo. Sono disponibili distanziali e base d'appoggio per la composizione dei vari sistemi modulari.

Modular system to combine furniture elements for different rooms and concepts. Some examples of the many combination possibilities are presented.

TECHNICAL DESCRIPTION

Solid wood and plywood structure. Outer structure available in lacquered wood or canaletto walnut veneer. Lacquered wood inner structure. Quilted alcantara back panel. Crystal shelves, bronze colour. Spacers and support base for the compositions are available.

Модульная система, которая комплектуется из элементов мебели для разных типов помещений и концепций. Предлагаем вашему вниманию несколько примеров из множества возможных комбинаций.

ТЕХНИЧЕСКОЕ ОПИСАНИЕ

Каркас из массива дерева и фанеры. Доступные материалы внешнего каркаса: лакированная древесина или шпон ореха канаletto. Лакированный внутренний каркас. Задняя панель отделана стеганой алькантарой. Хрустальной полкой, бронзового цвета. Имеются разделители и опорные элементы для составления композиций.

采用模块化系统，组合家具元素，以契合不同的房间和理念。许多可能组合的若干示例给出如下。

技术说明

实木和胶合板结构。外部结构可选用漆木或卡纳莱托胡桃木饰面，内部为喷漆结构。绗缝阿尔坎塔拉人造皮背板。水晶陈列架，青铜色。可选用组合垫片和支撑底座。

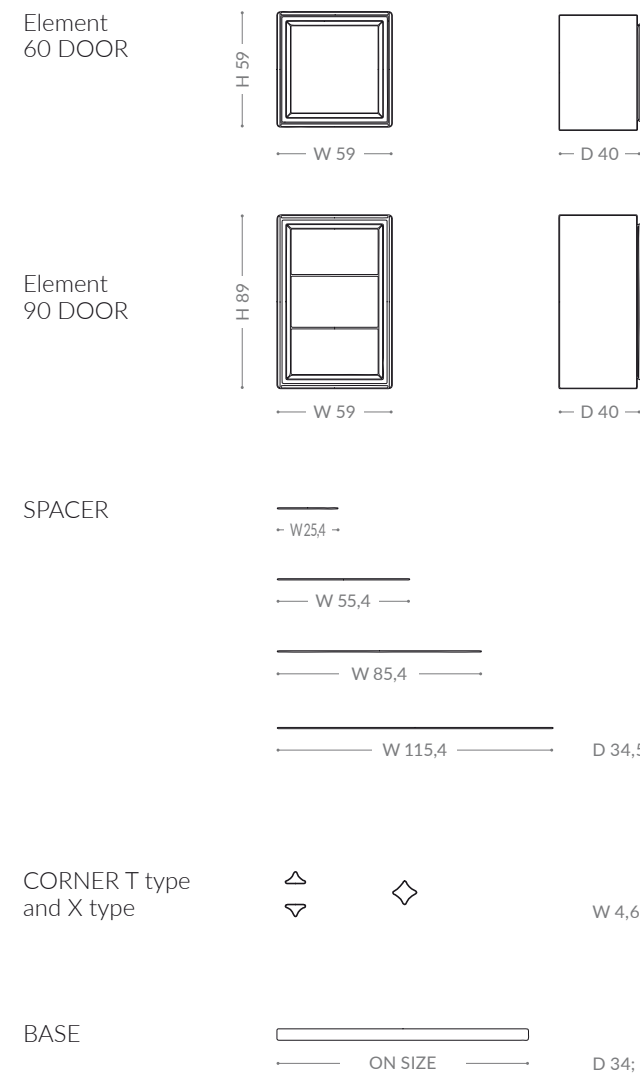
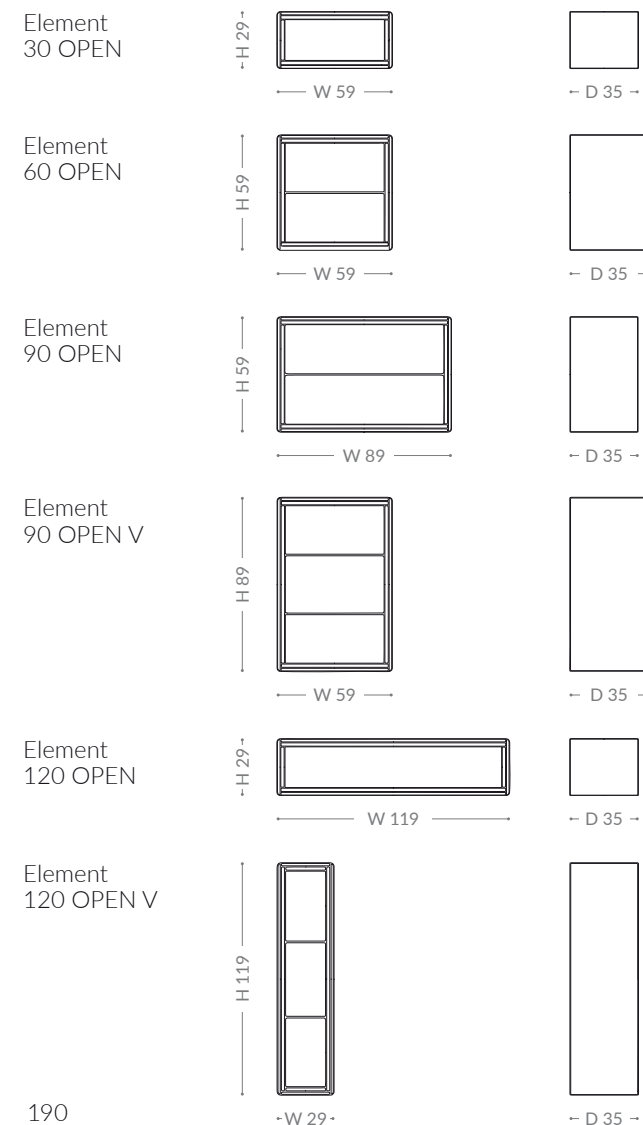

DEDALO

BACK SOFA CABINET



As picture: Dedalo back sofa cabinet
In price list: Prime

Lucidatura/Finishing/Отделка/饰面
70. CANALETTO WALNUT MATT
81. SAND MATT
85. CHOCOLATE MATT

Materiale/Material/Материал/材料
BZ 905-5234 LEATHER BEIGE

Vetro/Glass/Стекло/玻璃
BRONZE

DEDALO

CABINET



As picture: Dedalo cabinet
In price list: Brilliant

Lucidatura/Finishing/Отделка/饰面
69. CANALETTO WALNUT
89. TAUPE MATT
85. CHOCOLATE MATT

Materiale/Material/Материал/材料
BZ 906-2007 LEATHER MOKA

Vetro/Glass/Стекло/玻璃
изделие/玻璃
BRONZE

DEDALO

DUAL UNIT



As picture: Dedalo dual unit
In price list: Brilliant

Lucidatura/Finishing/Отделка/饰面
69. CANALETTO WALNUT
100. GREY MATT
92. TIFFANY MATT

Parti in metallo/Metal parts/Металлическая фурнитура/金属部件
SATIN TITANIUM

DEDALO

FREE STANDING PARTITION 1

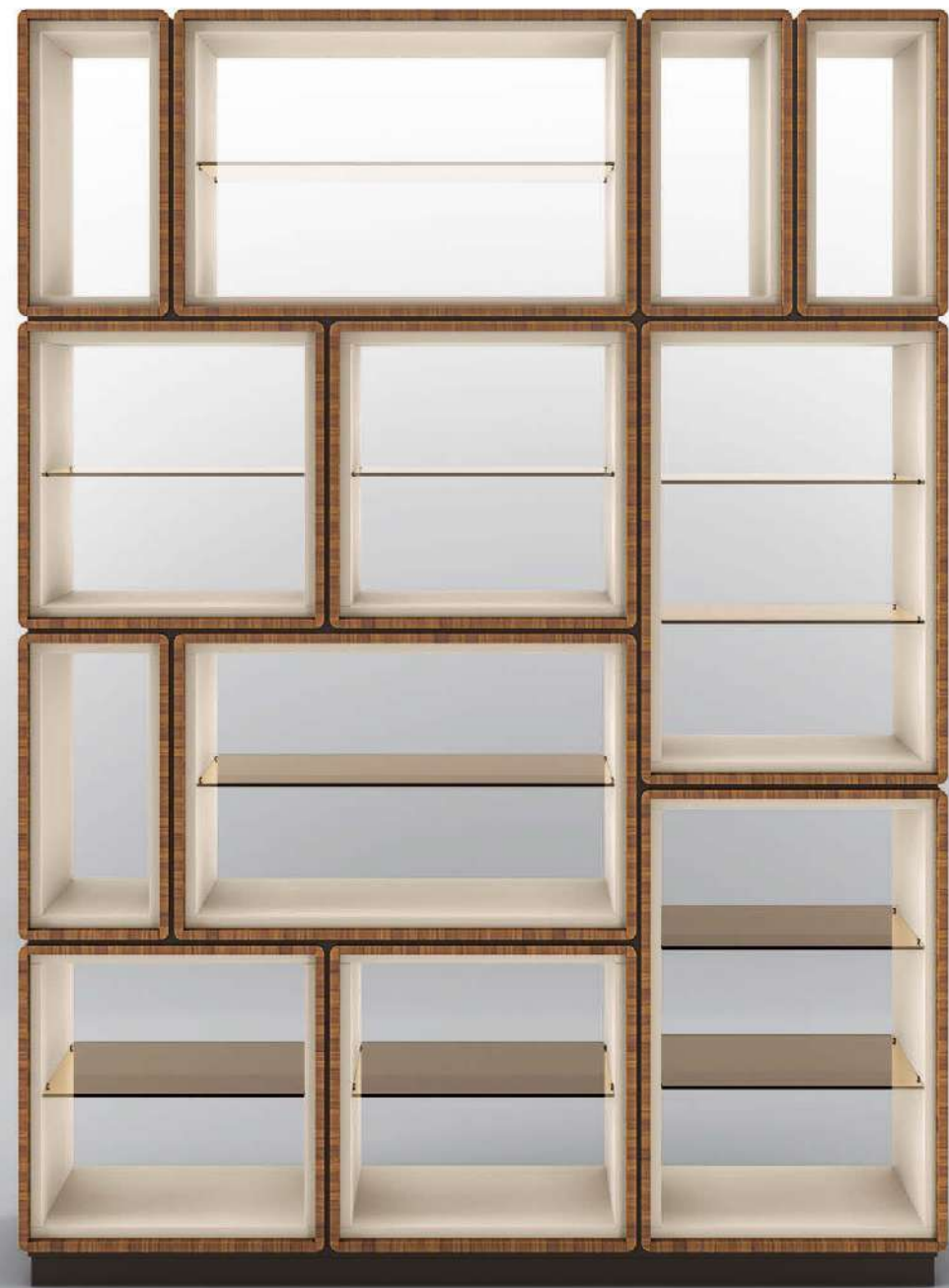

C A B I N E T S

**As picture: Dedalo
free standing partition 1**
In price list: Prime

Lucidatura/Finishing/Отделка/饰面
70. CANALETTO WALNUT MATT
81. SAND MATT
85. CHOCOLATE MATT

Vetro/Glass/Стекло
изделие/玻璃
BRONZE

DEDALO

FREE STANDING PARTITION 2



C A B I N E T S

**As picture: Dedalo
free standing partition 2**
In price list: Prime

Lucidatura/Finishing/Отделка/饰面
93. WENGÉ MATT
100. GREY MATT
85. CHOCOLATE MATT

Vetro/Glass/Стекло
изделие/玻璃
BRONZE

DEDALO

LIBRARY



DEDALO

OFFICE COMPOSITION

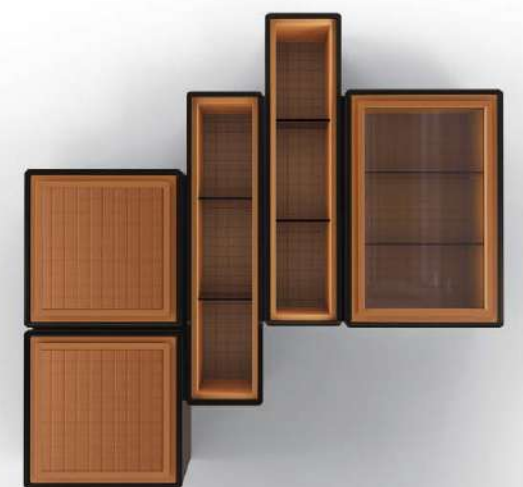

C A B I N E T S

As picture: Dedalo library
In price list: Brilliant

Lucidatura/Finishing/Отделка/饰面
69. CANALETTO WALNUT
85. CHOCOLATE MATT

Materiale/Material/Материал/材料
BZ 906-2003 LEATHER DARK BROWN

Vetro/Glass/Стекло
изделие/玻璃
BRONZE

As picture: Dedalo office composition
In price list: Brilliant

Lucidatura/Finishing/Отделка/饰面
57. CHOCOLATE
84. LOBSTER MATT
85. CHOCOLATE MATT

Materiale/Material/Материал/材料
BZ 905-5103 LEATHER LOBSTER

Vetro/Glass/Стекло
изделие/玻璃
BRONZE

C A B I N E T S

DEDALO

SIDEBOARD



As picture: Dedalo sideboard
In price list: Brilliant

Lucidatura/Finishing/Отделка/饰面
69. CANALETTO WALNUT
100. GREY MATT
85. CHOCOLATE MATT

Vetro/Glass/Стекло
изделие/玻璃
BRONZE

CABINETS

DEDALO

TV CABINET 1



As picture: Dedalo TV cabinet 1
In price list: Brilliant

Lucidatura/Finishing/Отделка/饰面
98. WENGÉ
90. CARAMEL MATT
85. CHOCOLATE MATT

CABINETS

DEDALO

TV COMPOSITION 1



C A B I N E T S

As picture: Dedalo TV composition 1
In price list: Prime

Lucidatura/Finishing/Отделка/饰面
70. CANALETTO WALNUT MATT
91. BURGUNDY MATT
85. CHOCOLATE MATT

Materiale/Material/Материал/材料
BZ 906-2030 LEATHER BURGUNDY

Vetro/Glass/Стекло
изделие/玻璃
BRONZE

DEDALO

TV COMPOSITION 2



As picture: Dedalo TV composition 2
In price list: Prime

Lucidatura/Finishing/Отделка/饰面
70. CANALETTO WALNUT MATT
81. SAND MATT
85. CHOCOLATE MATT

Materiale/Material/Материал/材料
BZ 905-5234 LEATHER BEIGE

Vetro/Glass/Стекло
изделие/玻璃
BRONZE

C A B I N E T S

DEDALO

TV COMPOSITION 3



C A B I N E T S

As picture: Dedalo TV composition 3
In price list: Prime

Lucidatura/Finishing/Отделка/饰面
70. CANALETTO WALNUT MATT
92. TIFFANY MATT
85. CHOCOLATE MATT

Vetro/Glass/Стекло
изделие/玻璃
BRONZE

DEDALO

WALL COMPOSITION



C A B I N E T S

As picture: Dedalo wall composition
In price list: Prime

Lucidatura/Finishing/Отделка/饰面
93. WENGÉ MATT
100. GREY MATT
85. CHOCOLATE MATT

Materiale/Material/Материал/材料
BZ 906-2006 LEATHER TAUPE

Vetro/Glass/Стекло
изделие/玻璃
BRONZE

FRITZ

BAR CABINET



Struttura in legno massello; gambe in legno intagliate a mano. Parte interna con ripiani in vetro e cassetti portaoggetti (schienale in specchio bronzo). Ante in legno laccato con maniglie in ottone.

Solid wood structure; Hand-carved wooden legs. Internally fitted with glass shelves and drawers (bronze mirror back panel). Lacquered wooden doors with brass handles.

Каркас из массива дерева, резные ножки ручной работы. Внутри установлены стеклянные полки и выдвижные ящики (зеркальная задняя панель бронзового оттенка). Двери из лакированной древесины с латунными ручками.

实木结构；木制柜脚采用手工雕刻。内部配有玻璃陈列架和抽屉（铜镜背板）。漆木柜门带有黄铜把手。

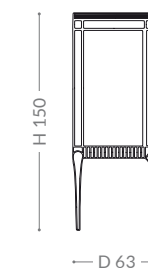
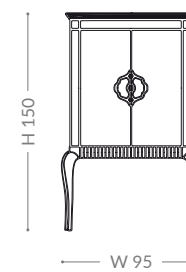

As picture: Fritz bar cabinet
In price list: Brilliant

Lucidatura/Finishing/Отделка/饰面
53. DOVE GREY

Parti in metallo/Metal parts/Металлическая фурнитура/金属部件
TITANIUM

RICHELIEU

BAR CABINET



Stuttura in metallo, legno massello e multistrati di legno. Piano disponibile in essenza di ebano makassar o eucalipto frisé. Parte esterna decorata in pelle ricamata. Gambe perimetrali in legno di faggio e dettagli in ottone. Parte interna allestita con 2 cassetti portaoggetti, 2 ripiani in vetro; schienale a specchio.

Metal, solid wood and plywood structure. Top available in makassar ebony or eucalyptus frisé veneer. Quilted leather outer body. Beechwood legs with brass details. Internally fitted with 2 drawers, 2 glass shelves; mirror back panel.

Каркас из металла, массива дерева и фанеры. Доступные материалы верхнего каркаса: шпон макаassarского эбена или эвкалипта frisé. Выполнена наружная отделка стеганой кожей. Ножки из бука с латунными деталями. Внутри установлены 2 выдвижных ящика, 2 стеклянные полки и зеркальная задняя панель.

金属、实木及胶合板结构。台面可选用孟加锡乌木饰面或桉木饰面。外部为衍缝皮革。山毛榉柜脚带有黄铜配饰。内部配有 2 个抽屉，2 个玻璃陈列架；镜面背板。

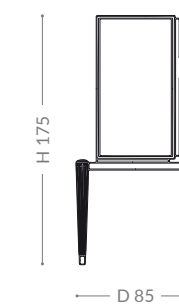
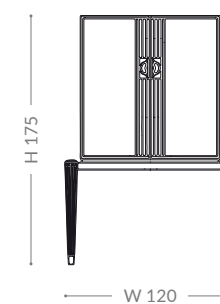

RICHELIEU

GAMING CABINET



Stuttura in metallo, legno massello e multistrati di legno. Piano disponibile in essenza di ebano makassar o eucalipto frisé. Parte esterna decorata in pelle ricamata. Gambe perimetrali in legno di faggio e dettagli in ottone. Parte interna rivestita in alcantara e pelle, allestita con roulette da tavolo con accessori, 2 cassetti portagiochi, vano bottiglie alcolici e umidificatore sigari.

Metal, solid wood and plywood structure. Top available in makassar ebony or eucalyptus frisé veneer. Quilted leather outer body. Beechwood legs with brass details. Alcantara and leather padded internals, fitted with roulette and accessories, drawers for card games accessories, bottle compartment, cigar humidifier.

Каркас из металла, массива дерева и фанеры. Доступные материалы верхнего каркаса: шпон макассарского эбена или эвкалипта фризе. Выполнена наружная отделка стеганой кожей. Ножки из бука с латунными деталями. Выполнена внутренняя отделка алькантарой и кожей, установлены рулетка с аксессуарами, выдвижные ящики для принадлежностей к карточным играм, отделение для бутылок и увлажнитель сигар.

金属、实木及胶合板结构。台面可选用孟加锡乌木饰面或桉木饰面。外部为衍缝皮革。山毛榉柜脚带有黄铜配饰。内部采用阿尔坎塔拉人造皮和皮革衬垫，配有轮盘赌及配件、卡牌游戏配件抽屉、瓶罐收纳架、雪茄加湿器。

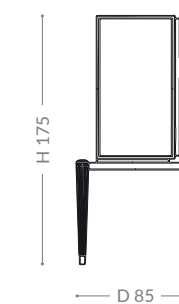
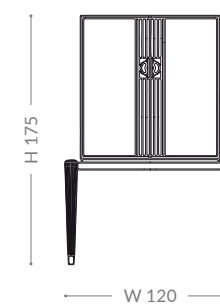

As picture: Richelieu gaming cabinet
In price list: Brilliant

Lucidatura/Finishing/Отделка/饰面
65. MAKASSAR
57. CHOCOLATE

Parti in metallo/Metal parts/Металлическая фурнитура/金属部件
GOLD

Materiale/Material/Материал/材料
BZ 901-332 LEATHER BUTTER

VENUS

CABINET



Struttura in noce canaletto massello. Ripiani interni in vetro, schienale a specchio. Ante in noce canaletto curvato e maniglie in metallo satinato.

Canaletto walnut solid wooden structure. Glass shelves and mirror back panel. Curved canaletto walnut wooden doors and satin metal handles.

Каркас из массива ореха каналетто. Стеклянные полки и зеркальная задняя панель. Двери из изогнутой древесины ореха каналетто с ручками из сатинированного металла.

卡纳莱托胡桃木实木结构。玻璃陈列架和镜面背板。曲面卡纳莱托胡桃木门和缎纹金属把手。

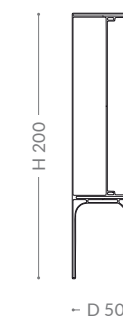
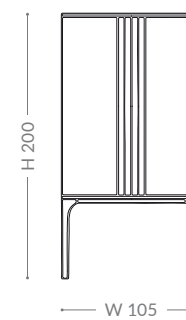

As picture: Venus cabinet
In price list: Brilliant

Lucidatura/Finishing/Отделка/饰面
69. CANALETTO WALNUT

Parti in metallo/Metal parts/Металлическая фурнитура/金属部件
SATIN GOLD

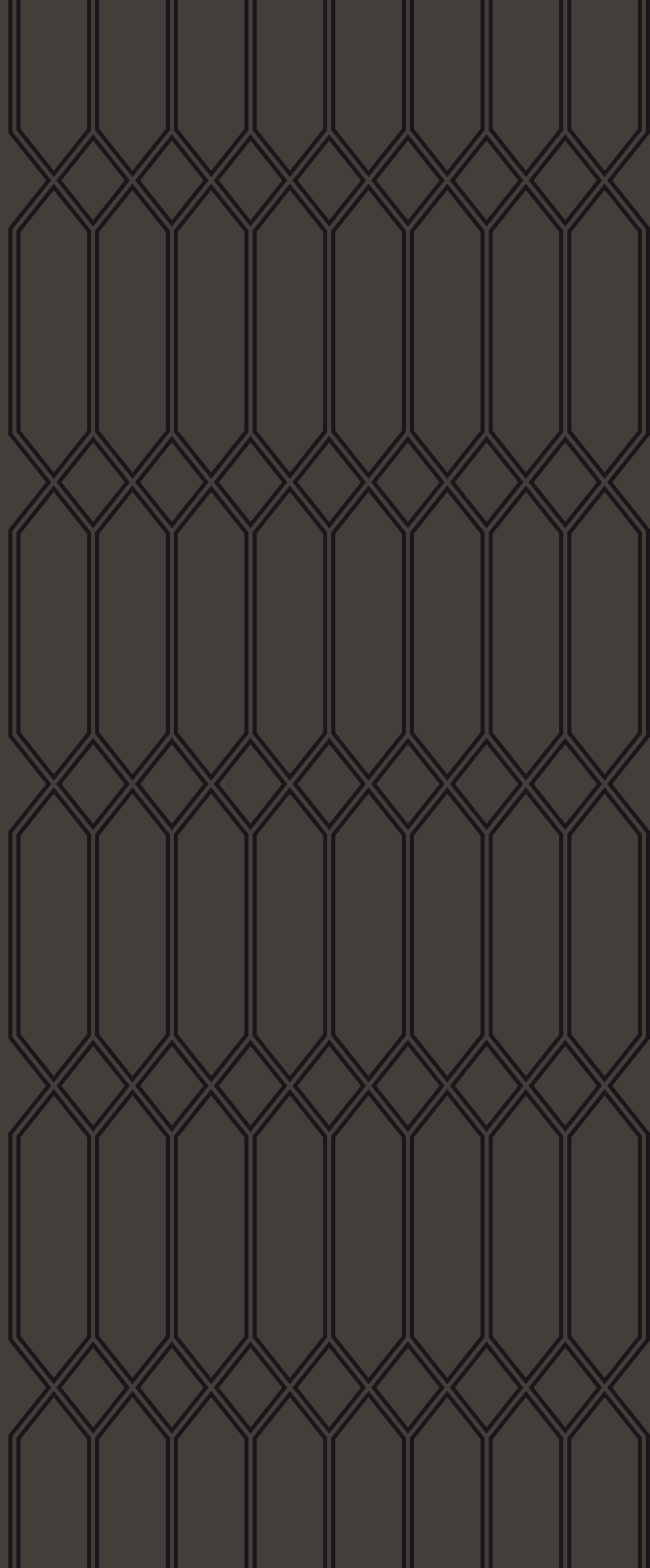

ZB

DESKS



ASTORIA

DESK



Struttura in legno massello, multistrati curvato e MDF. Piano disponibile in essenza di ebano makassar. Top e parti esterne decorati in pelle ricamata. Profili e dettagli in metallo. Passacavi in metallo multifunzione. Sottomano in pelle disponibile su richiesta.

Solid wood frame, curved plywood and MDF. Top available in makassar ebony veneer. Quilted leather decorated top and outer body. Metal details and profiles. Multifunctional metal cable organizer. Leather desk pad on request.

Рама из массива дерева, изогнутой фанеры и МДФ. Столешница из шпона макассарского эбена. Отделка столешницы и внешней части каркаса стеганой кожей. Металлические детали и профили. Многофункциональная металлическая заглушка для кабеля. Кожаная настольная подкладка можно приобрести по запросу.

实木框架，曲面胶合板和中密度纤维板。桌面为孟加锡乌木饰面。桌面和外部框架采用绗缝皮革装饰。金属配饰和侧面轮廓。多功能金属理线器。可应要求提供皮革书桌垫。

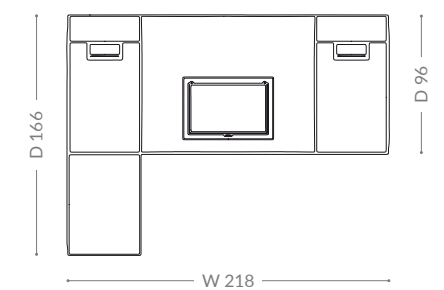
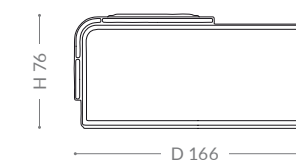
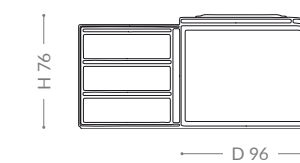
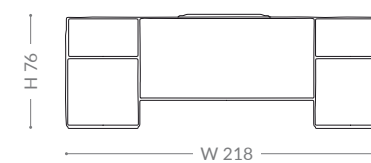
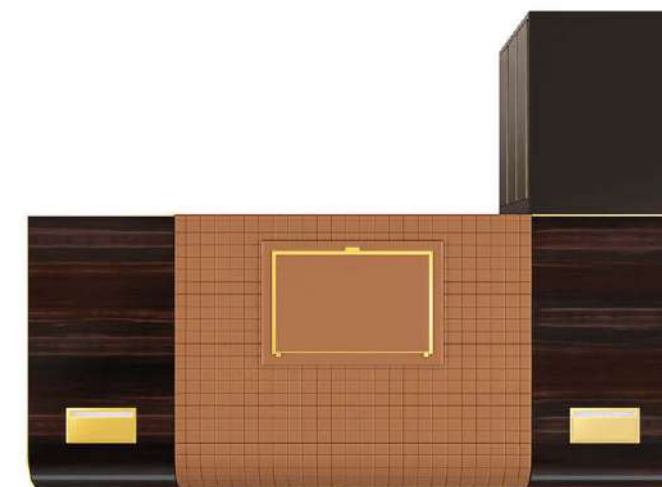

D E S K S

As picture: Astoria desk
In price list: Brilliant/Leather desk pad on request.

Lucidatura/Finishing/Отделка/饰面
65. MAKASSAR
57. CHOCOLATE

Parti in metallo/Metal parts/Металлическая фурнитура/金属部件
GOLD

Materiale/Material/Материал/材料
BZ 905-5103 LEATHER LOBSTER

CLARK

DESK

Struttura in legno massello, multistrati di legno e MDF. Decorazione frontale in metallo. Disponibile con uno o due passacavi. Sottomano rivestito in pelle.

Solid wood, plywood and MDF frame. Metal frontal decoration. Available with one or two cable organizers. Leather desk pad.

Рама из массива дерева, фанеры и МДФ. Фронтальная металлическая отделка. Доступен с одной или двумя заглушками для кабеля. Кожаная настольная подкладка.

实木、胶合板、以及中密度纤维板 (MDF) 框架。正面采用金属装饰。可装配一个或两个理线器。包含皮革书桌垫。



D E S K S



As picture: Clark desk
In price list: Brilliant

Lucidatura/Finishing/Отделка/饰面
57. CHOCOLATE

Parti in metallo/Metal parts/Металлическая фурнитура/金属部件
TITANIUM

Materiale/Material/Материал/材料
BZ 901-965 LEATHER BLACK

LEGEND

DESK

Struttura in legno massello, multistrati di legno e MDF. Piano in legno laccato. Decorazione parte esterna e cassetti in pelle ricamata con dettagli in metallo. Colonne decorative in legno e ottone. Disponibile con uno o due passacavi. Sottomano in pelle disponibile su richiesta.

Solid wood, plywood and MDF frame. Lacquered wooden top. Quilted leather outer body and drawers, with metal details. Wooden and brass legs. Available with one or two cable organizers. Leather desk pad on request.

Рама из массива дерева, фанеры и МДФ. Столешница из лакированной древесины. Внешняя часть каркаса и выдвижные ящики с отделкой стеганой кожей, металлические детали. Ножки из дерева и латуни. Доступен с одной или двумя заглушками для кабеля. Кожаная настольная подкладка можно приобрести по запросу.

实木、胶合板、以及中密度纤维板 (MDF) 框架。漆木桌面。外部框架和抽屉采用绗缝皮革，带有精细金属配饰。木制黄铜桌腿。可装配一个或两个理线器。可按要求提供皮革书桌垫。

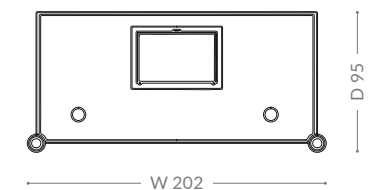
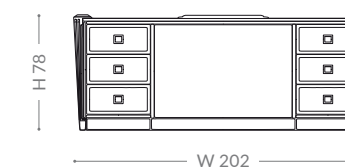
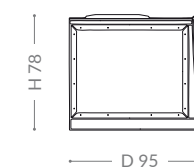
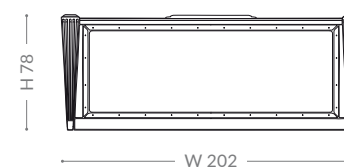
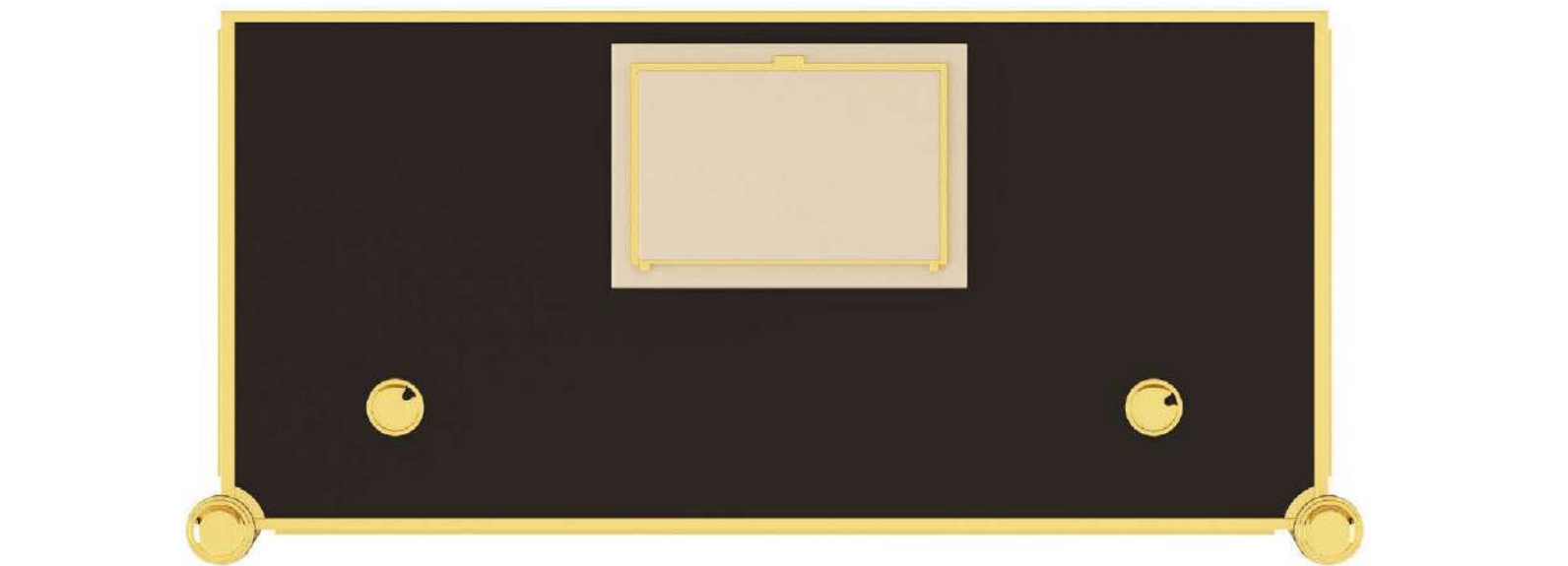

As picture: Legend desk
In price list: Brilliant/Leather desk pad on request.

Lucidatura/Finishing/Отделка/饰面
57. CHOCOLATE

Parti in metallo/Metal parts/Металлическая фурнитура/金属部件
GOLD

Materiale/Material/Материал/材料
BZ 901-891 LEATHER IVORY

SQUARE

DESK



Struttura in legno massello, multistrati di legno e metallo martellato. Piano scrivania in essenza di noce canaletto. Disponibile con uno o due passacavi. Sottomano in pelle. Sottomano in pelle disponibile su richiesta.

Solid wood frame, plywood and hammered metal. Canaletto walnut veneer top. Available with one or two cable organizers. Leather desk pad on request.

Рама из массива дерева, фанеры и кованого металла. Столешница из шпона ореха каналетто. Доступен с одной или двумя заглушками для кабеля. Кожа на настольная подкладка можно приобрести по запросу.

实木框架，胶合板和锤纹金属。桌面采用卡纳莱托胡桃木饰面。可装配一个或两个理线器。可应要求提供皮革书桌垫。

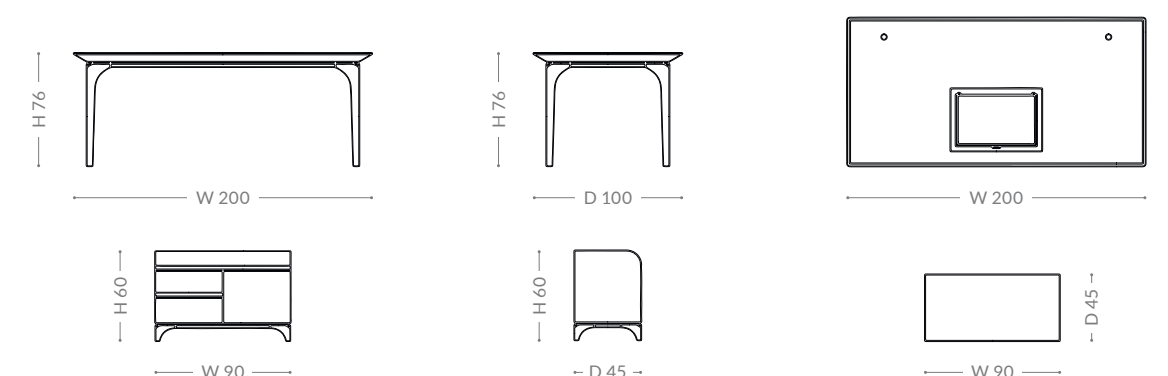

DESKS

As picture: Square desk + return desk
In price list: Prime/Leather desk pad on request.

Scrivania/Desk/Стол/书桌
89. TAUPE MATT
70. CANALETTO WALNUT MATT

Parti in metallo/Metal parts/Металлическая фурнитура/金属部件
HAMMERED GOLD
Materiale/Material/Материал/材料
BZ 906-2007 LEATHER MOKA

Cassettiera/Return desk/Тумба/
小五斗柜
89. TAUPE MATT
70. CANALETTO WALNUT MATT

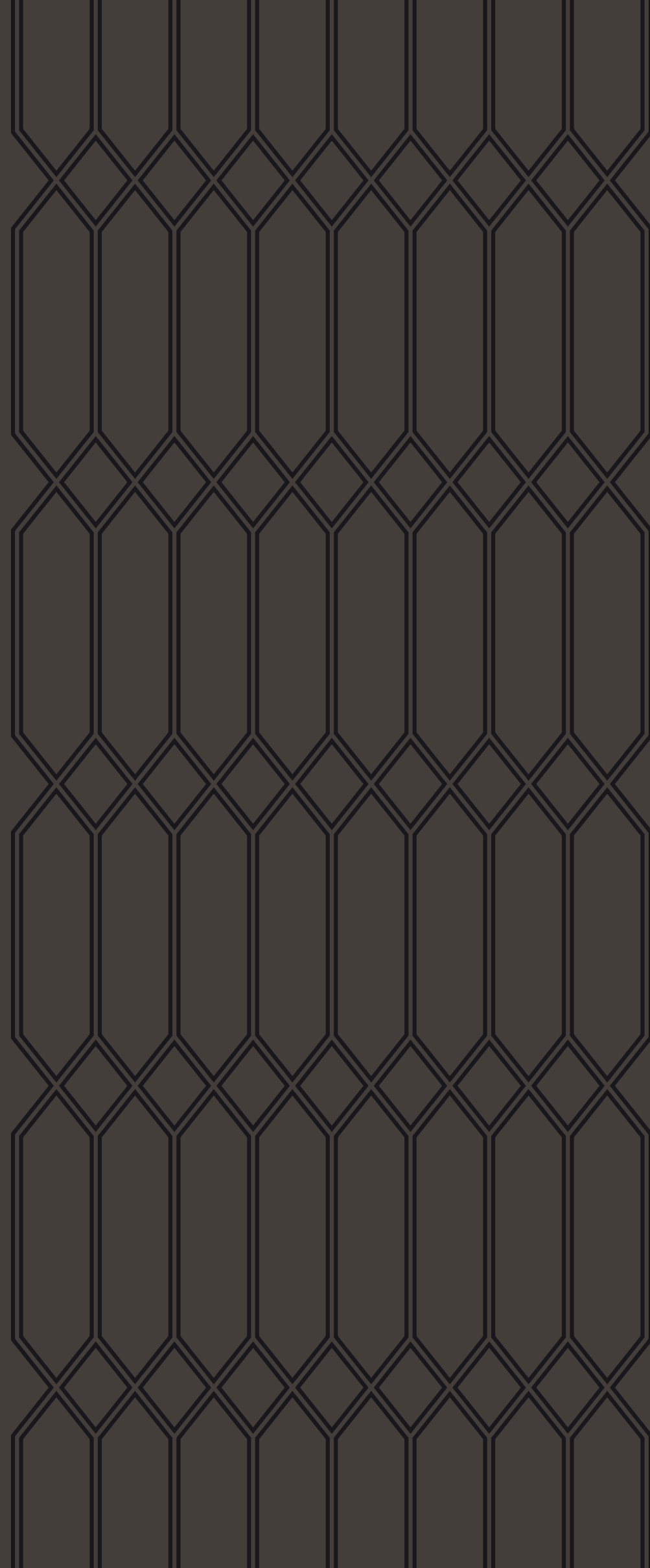

ZB

OFFICE CHAIRS



ATLANTIS

OFFICE CHAIR



As picture: Atlantis office chair
In price list: Ambition/Brilliant

Materiale/Material/Материал/材料
BZ 901-891 LEATHER IVORY

Lucidatura/Finishing/Отделка/饰面
53. DOVE GREY

Struttura in legno massello e multistrati di legno. Guscio in pelle ricamata. Parte interna decorata con lavorazione capitonné. Imbottiture in poliuretano espanso a quote differenziate. Base a 5 razze in metallo e legno laccato con ruote "Design", regolabile in altezza.

Solid wood and plywood frame. Quilted leather shell. Capitoné inner body. Multiple densities polyurethane foam padding. 5 feet metal base and lacquered wood with "Design" wheels, adjustable height.

Рама из массива дерева и фанеры. Обшивка стеганой кожей. Внутренняя часть каркаса с отделкой в виде каретной стяжки. Набивка из пенополиуретана разной плотности. Основа из металла и лакированной древесины, с 5 роликами Design, регулируемая высота.

实木胶合板框架。外壳采用绗缝皮革。内部饱满。多重密度聚氨酯泡沫填充垫料。5 英尺金属底座（以及漆木）配有“专属设计”车轮，高度可调。

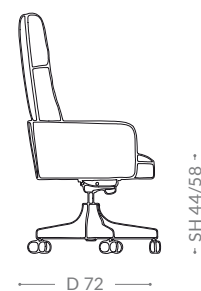
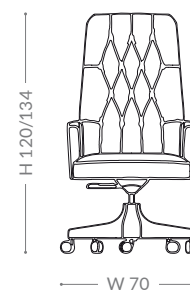

COMET

FRONT DESK CHAIR



As picture: Comet front desk chair
In price list: Ambition/Brilliant

Materiale/Material/Материал/材料
BZ 905-5103 LEATHER LOBSTER

Lucidatura/Finishing/Отделка/饰面
57. CHOCOLATE

Parti in metallo/Metal parts/
Металлическая фурнитура/
金属部件
GOLD

Struttura in legno massello. Schienale e parte esterna in pelle ricamata. Decorazione con bottoni rivestiti in pelle. Imbottiture in poliuretano a quote differenziate. Guscio esterno in legno laccato. Base a 5 razze in metallo con ruote "Design", regolabile in altezza.

Solid wood frame. Quilted leather backrest and outer body. Finished with leather covered nails. Multiple densities polyurethane foam padding. Lacquered wooden shell. 5 feet metal base with "Design" wheels, adjustable height.

Рама из массива дерева. Спинка и внешняя часть каркаса с отделкой стеганой кожей. Стержни, обтянутые кожей. Набивка из пенополиуретана разной плотности. Обшивка из лакированной древесины. Металлическая основа с 5 роликами Design, регулируемая высота.

实木框架。靠背和外部框架采用绗缝皮革。采用包裹皮革的铆钉装饰固定。多重密度聚氨酯泡沫填充垫料。漆木外壳。5 英尺金属底座配有“专属设计”椅轮，高度可调。



COMET

OFFICE CHAIR

LONDON

OFFICE CHAIR

OFFICE CHAIRS



As picture: Comet office chair
In price list: Ambition/
Brilliant

Materiale/Material/Материал/材料
BZ 905-5103 LEATHER LOBSTER



Lucidatura/Finishing/Отделка/饰面
57. CHOCOLATE

Parti in metallo/Metal parts/Металлическая фурнитура/金属部件
GOLD

Struttura in legno massello. Schienale e parte esterna in pelle ricamata. Decorazione con bottoni rivestiti in pelle. Imbottiture in poliuretano a quote differenziate. Guscio esterno in legno laccato. Base a 5 razze in metallo con ruote "Design", regolabile in altezza.

Solid wood frame. Quilted leather backrest and outer body. Finished with leather covered nails. Multiple densities polyurethane foam padding. Lacquered wooden shell. 5 feet metal base with "Design" wheels, adjustable height.

Рама из массива дерева. Спинка и внешняя часть каркаса с отделкой стеганой кожей. Стержни, обтянутые кожей. Набивка из пенополиуретана разной плотности. Обшивка из лакированной древесины. Металлическая основа с 5 роликами Design, регулируемая высота.

实木框架。靠背和外部框架采用绗缝皮革。采用包裹皮革的铆钉装饰固定。多重密度聚氨酯泡沫填充垫料。漆木外壳。5 英尺金属底座配有“专属设计”椅轮，高度可调。

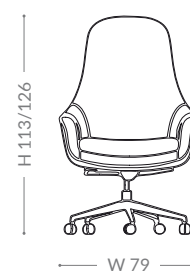

As picture: London office chair
In price list: Ambition

Materiale/Material/Материал/材料
BZ 901-965 LEATHER BLACK



Parti in metallo/Metal parts/Металлическая фурнитура/金属部件
CHROME

Struttura in legno massello e multistrati di legno. Imbottiture in poliuretano espanso a quote differenziate. Base a 5 razze in metallo con ruote "Design", regolabile in altezza.

Solid wood and plywood frame. Multiple densities polyurethane foam padding. 5 feet metal base with "Design" wheels, adjustable height.

Рама из массива дерева и фанеры. Набивка из пенополиуретана разной плотности. Металлическая основа с 5 роликами Design, регулируемая высота.

实木胶合板框架。多重密度聚氨酯泡沫填充垫料。5 英尺金属底座配有“专属设计”椅轮，高度可调。



OFFICE CHAIRS

REGENT

FRONT DESK CHAIR

OFFICE CHAIRS



As picture: Regent front desk chair
In price list: Ambition

Materiale/Material/Материал/材料
BZ 905-5141 LEATHER DARK GREY



Lucidatura/Finishing/Отделка/饰面
70. CANALETTO WALNUT MATT

Parti in metallo/Metal parts/Металлическая фурнитура/金属部件
SATIN GOLD - GOLD

Struttura in legno massello. Parte interna e braccioli in pelle ricamata. Parte esterna disponibile in essenza di noce canaletto. Telaio braccioli in metallo satinato. Imbottiture in poliuretano a quote differenziate. Base a 5 razze in metallo con ruote "Design", regolabile in altezza.

Solid wood frame. Quilted leather inner body and armrests. Canaletto walnut wooden veneer outer body. Satin metal armrests frame. Multiple densities polyurethane foam padding. 5 feet metal base with "Design" wheels, adjustable height.

Рама из массива дерева. Внутренняя часть каркаса и подлокотники из стеганой кожи. Внешняя часть каркаса из шпона ореха каналетто. Рама подлокотников из сатинированного металла. Набивка из пенополиуретана разной плотности. Металлическая основа с 5 роликами Design, регулируемая высота.

实木框架。内部框架和扶手采用绗缝皮革。外部框架采用卡纳莱托胡桃木饰面。缎纹金属扶手框架。多重密度聚氨酯泡沫填充垫料。5英尺金属底座配有“专属设计”椅轮，高度可调。

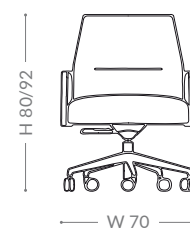

REGENT

OFFICE CHAIR



As picture: Regent office chair
In price list: Ambition

Materiale/Material/Материал/材料
BZ 905-5141 LEATHER DARK GREY



Lucidatura/Finishing/Отделка/饰面
70. CANALETTO WALNUT MATT

Parti in metallo/Metal parts/Металлическая фурнитура/金属部件
SATIN GOLD - GOLD

Struttura in legno massello. Parte interna e braccioli in pelle ricamata. Parte esterna disponibile in essenza di noce canaletto. Telaio braccioli in metallo satinato. Imbottiture in poliuretano a quote differenziate. Base a 5 razze in metallo con ruote "Design", regolabile in altezza.

Solid wood frame. Quilted leather inner body and armrests. Canaletto walnut wooden veneer outer body. Satin metal armrests frame. Multiple densities polyurethane foam padding. 5 feet metal base with "Design" wheels, adjustable height.

Рама из массива дерева. Внутренняя часть каркаса и подлокотники из стеганой кожи. Внешняя часть каркаса из шпона ореха каналетто. Рама подлокотников из сатинированного металла. Набивка из пенополиуретана разной плотности. Металлическая основа с 5 роликами Design, регулируемая высота.

实木框架。内部框架和扶手采用绗缝皮革。外部框架采用卡纳莱托胡桃木饰面。缎纹金属扶手框架。多重密度聚氨酯泡沫填充垫料。5英尺金属底座配有“专属设计”椅轮，高度可调。

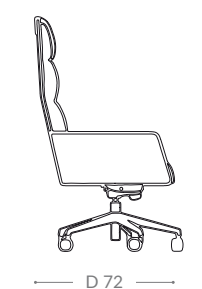
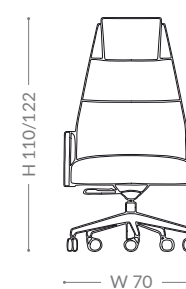

ARTEMIDE

MIRROR



As picture: Artemide mirror
In price list: Prime

Lucidatura/Finishing/Отделка/饰面
91. BURGUNDY MATT

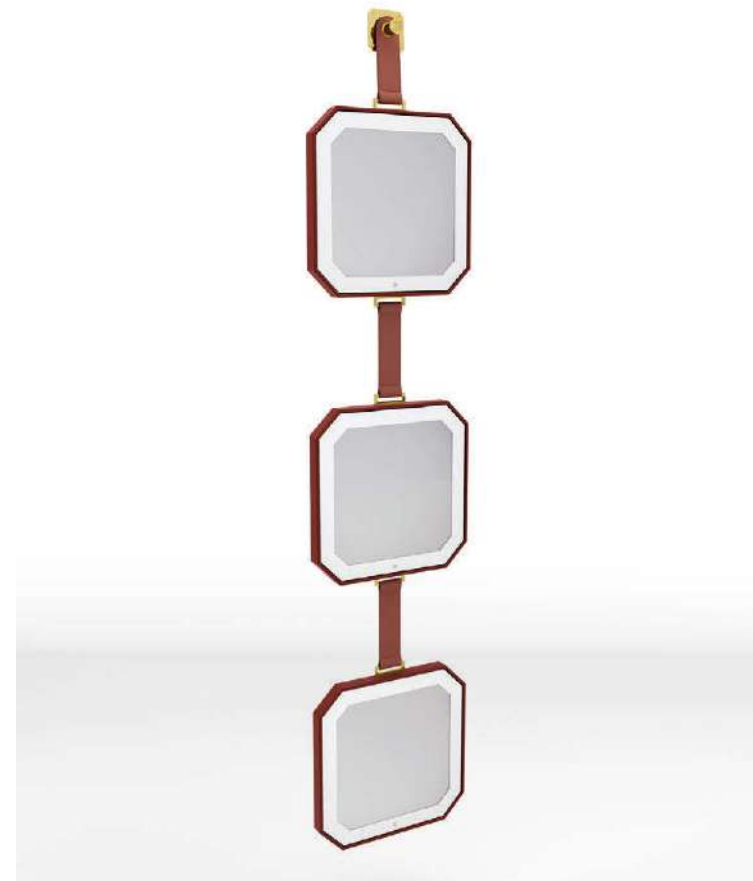

Materiale/Material/Материал/材料
BZ 906-2030 LEATHER BURGUNDY

Parti in metallo/Metal parts/Металлическая фурнитура/金属部件
GOLD

Specchio extra white con perimetro sabbiato su supporto in multistrati di legno laccato. Composto da 3 elementi uniti da cintura in pelle e ganci metallici. Predisposto per aggancio a parete.

Extra white mirror with sandblasted profile on plywood lacquered support. Composed by 3 elements joined with leather band and metal hooks. Wall fittings included.

Очень яркое зеркало с профилем, подвергнутым пескоструйной обработке, на лакированной основе из фанеры. Состоит из 3 элементов, соединенных кожаным ремешком и металлическими крючками. Настенные крепления входят в комплект.

超亮镜面，喷砂工艺轮廓线条，喷漆胶合板底座。整体由三个部分组成，通过皮带和金属挂钩连在一起。含挂墙配件。

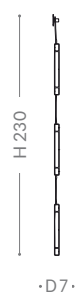
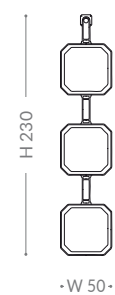

CONSTANCE

MIRROR



As picture: Constance mirror
In price list: Brilliant

Lucidatura/Finishing/Отделка/饰面
57. CHOCOLATE
65. MAKASSAR



Parti in metallo/Metal parts/Металлическая фурнитура/金属部件
GOLD

Struttura in metallo con cornice e formelle in legno laccato. Specchio centrale convesso. Dettagli in metallo e ebano makassar.

Metal structure with laquered wooden frame and decorative tiles. Convex mirror. Metal and ebony makassar details.

Металлический каркас с лакированной деревянной рамой и декоративными плитками. Выпуклое зеркало. Детали из металла и макаassarского эбена.

金属架构，漆木镜框，饰以装饰拼贴。凸面镜。点缀金属和孟加锡乌木细节。

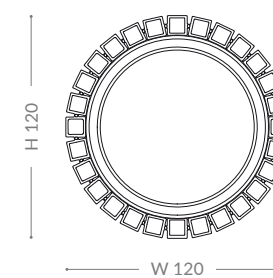

ETIENNE

MIRROR

M I R R O R S



As picture: Etienne large mirror
In price list: Brilliant

Lucidatura/Finishing/Отделка/饰面
57. CHOCOLATE
65. MAKASSAR

Parti in metallo/Metal parts/Металлическая фурнитура/金属部件
GOLD

Struttura in multistrati di legno con profili in metallo. Specchio extra white e supporti in ottone. Disponibile in legno laccato, essenza di ebano makassar o essenza di palissandro; con illuminazione a LED. Dimensioni previste: grande e piccola.

Plywood structure with metal profiles. Extra white mirror with brass supports. Available in lacquered wood, makassar ebony or palisander veneer; LED lighting included. Available sizes: large and small.

Каркас из фанеры с металлическими профилями. Осветленное зеркало с опорами из латуни. Доступные материалы: лакированная древесина или шпон макассарского эбена или шпон палисандра. Светодиодная подсветка входит в комплект. Доступные размеры: большое и маленькое зеркало.

胶合板架构, 金属轮廓线条。超白镜面, 黄铜底座。可选漆木, 孟加锡乌木饰面或花梨木饰面板, 含 LED 照明。可选尺寸: 大号和小号。

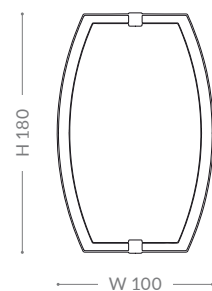

ETIENNE large

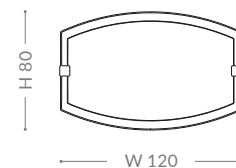

ETIENNE small

FLYNN

MIRROR

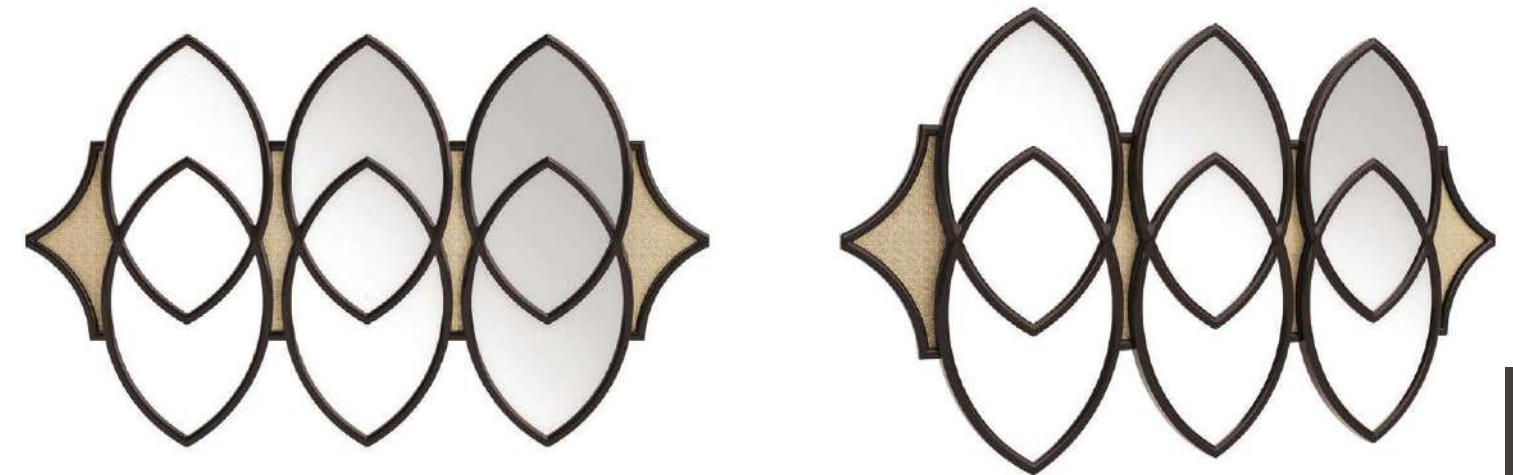

As picture: Flynn mirror
In price list: Brilliant

Lucidatura/Finishing/Отделка/饰面
57. CHOCOLATE

Materiale/Material/Материал/材料
BZ 188-07 BOUCLÉ SAND

Struttura realizzata in multistrati di legno e legno massello. Decorata con pannello rivestito in tessuto. Specchio extra white.

Plywood and solid wood structure. Decorated with fabric covered panel. Extra white mirror.

Каркас из фанеры и массива дерева. Отделка из панели, обитой тканью. Осветленное зеркало.

胶合板和实木结构。布艺包面板材。超白镜面。

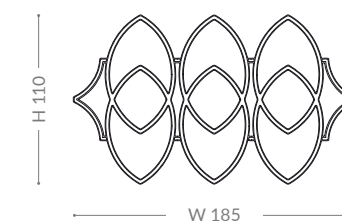

M I R R O R S

IKE

MIRROR



As picture: Ike mirror
In price list: Brilliant

Lucidatura/Finishing/Отделка/饰面
64. CANALETTO WALNUT
57. CHOCOLATE

Pannello in multistrati di legno e MDF. Disponibile in legno laccato, ebano makassar o noce canaletto. Specchio centrale extra white.

Plywood and MDF panel. Available in lacquered wood, makassar ebony or canaletto walnut veneer. Extra white central mirror.

Панель из фанеры и МДФ. Доступные материалы: лакированная древесина, шпон макассарского эбена и ореха каналетто. Осветленное центральное зеркало.

胶合板和中密度纤维板。可选用漆木、孟加锡乌木或卡纳莱托胡桃木饰面。超白中心镜。

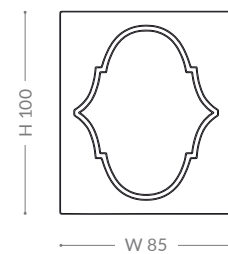

JUPITER

MIRROR



As picture: Jupiter mirror
In price list: Brilliant

Lucidatura/Finishing/Отделка/饰面
64. CANALETTO WALNUT
57. CHOCOLATE

Parti in metallo/Metal parts/Металлическая фурнитура/金属部件
GOLD

Pannello in multistrati di legno con perimetro laccato e viti decorative. Disponibile in legno laccato, ebano makassar o noce canaletto. Dettaglio in metallo. Specchio centrale extra white.

Plywood panel with lacquered profile and decorative screws. Available in lacquered wood, makassar ebony or canaletto walnut veneer. Metal details. Extra white central mirror.

Панель из фанеры с лакированным профилем и декоративными болтами. Доступные материалы: лакированная древесина, шпон макассарского эбена и ореха каналетто. Металлические детали. Осветленное центральное зеркало.

胶合板材，喷漆轮廓处理，点缀装饰螺钉。可选用漆木、孟加锡乌木或卡纳莱托胡桃木饰面。精细金属配饰。超白中心镜。

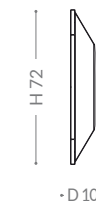
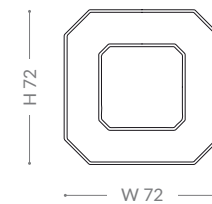

OSIRIS

RECTANGULAR MIRROR



M I R R O R S

As picture: Osiris rectangular mirror
In price list: Prime

Lucidatura/Finishing/Отделка/饰面
85. CHOCOLATE MATT

Materiale/Material/Материал/材料
BZ 906-2003 LEATHER DARK BROWN

Struttura in legno rivestita in pelle e pannello in multistrati di legno laccato. Specchio extra white.

Leather covered wooden structure and lacquered plywood panel. Extra white mirror.

Каркас из древесины, покрытой кожей, и панель из лакированной фанеры. Осветленное зеркало.

皮革包裹木质架构和喷漆胶合板材。超白镜面。

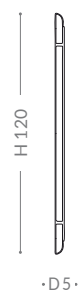
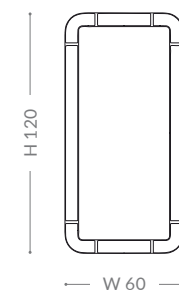

OSIRIS

ROUND MIRROR



M I R R O R S

As picture: Osiris round mirror
In price list: Prime

Lucidatura/Finishing/Отделка/饰面
80. IVORY MATT

Materiale/Material/Материал/材料
BZ 905-5234 LEATHER BEIGE

Struttura in legno rivestita in pelle e pannello in multistrati di legno laccato. Specchio extra white.

Leather covered wooden structure and lacquered plywood panel. Extra white mirror.

Каркас из древесины, покрытой кожей, и панель из лакированной фанеры. Осветленное зеркало.

皮革包裹木质架构和喷漆胶合板材。超白镜面。

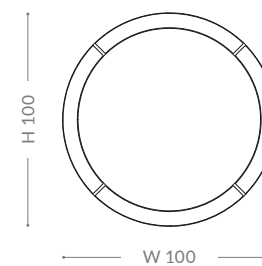

SHIRLEY

MIRROR



As picture: Shirley mirror
In price list: Brilliant

Lucidatura/Finishing/Отделка/饰面
53. DOVE GREY

Materiale/Material/Материал/材料
BZ 904-4632 LEATHER SAND

Pannello in multistrati di legno, rivestito in pelle ricamata. Decorato con cornice traforata in legno laccato. Specchio extra white con disegno sabbato.

Plywood panel, covered in quilted leather. Lacquered wooden fretwork frame. Extra white mirror with sandblasted decoration.

Панель из фанеры, обитая стеганой кожей. Резная рама из лакированной древесины. Осветленное зеркало с декоративными элементами, выполненными с помощью пескоструйной обработки.

胶合板材质地，包裹绗缝皮革。漆木浮雕细工镜框。超白镜面，点缀喷砂装饰。

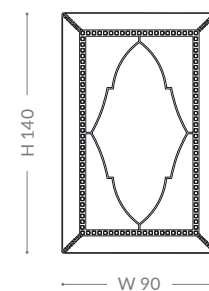

TWIN

MIRROR



As picture: Twin mirror
In price list: Prime

Lucidatura/Finishing/Отделка/饰面
85. CHOCOLATE MATT

Parti in metallo/Metal parts/Металлическая фурнитура/金属部件
SATIN GOLD

Struttura in metallo satinato e pannello in multistrati di legno laccato. Specchio extra white.

Satin metal and lacquered plywood structure. Extra white mirror.

Каркас из сатинированного металла и лакированной фанеры. Осветленное зеркало.

缎纹金属和漆木胶合板结构。超白镜面。

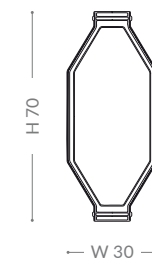

TWIN

MIRRORS COMPOSITION 1

M I R R O R S

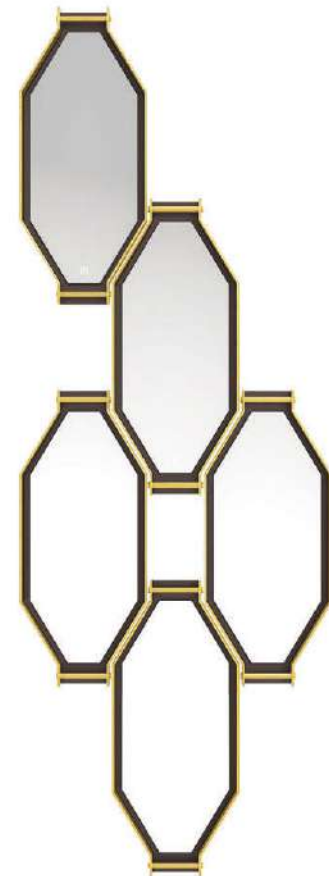

As picture: Twin mirrors composition 1
In price list: Prime

Lucidatura/Finishing/Отделка/饰面
85. CHOCOLATE MATT

Parti in metallo/Metal parts/Металлическая фурнитура/金属部件
SATIN GOLD

Struttura in metallo satinato e pannello in multistrati di legno laccato. Specchio extra white. Composizione: 5 elementi singoli in posizione verticale.

Satin metal and lacquered plywood structure. Extra white mirror. Composition: 5 single elements, vertically positioned.

Каркас из сатинированного металла и лакированной фанеры. Осветленное зеркало. Композиция: 5 отдельных элементов, расположенных вертикально.

缎纹金属和漆木胶合板结构。超白镜面。组成部分：5个独立组成部分，竖直放置。

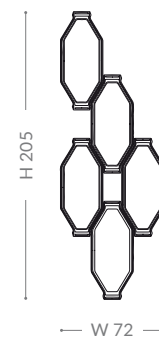

TWIN

MIRRORS COMPOSITION 2

M I R R O R S



As picture: Twin mirrors composition 2
In price list: Prime

Lucidatura/Finishing/Отделка/饰面
81. SAND MATT

Parti in metallo/Metal parts/Металлическая фурнитура/金属部件
SATIN TITANIUM

Struttura in metallo satinato e pannello in multistrati di legno laccato. Specchio extra white. Composizione: 5 elementi singoli in posizione orizzontale.

Satin metal and lacquered plywood structure. Extra white mirror. Composition: 5 single elements, horizontally positioned.

Каркас из сатинированного металла и лакированной фанеры. Осветленное зеркало. Композиция: 5 отдельных элементов, расположенных горизонтально.

缎纹金属和漆木胶合板结构。超白镜面。组成部分：5个独立组成部分，水平放置。

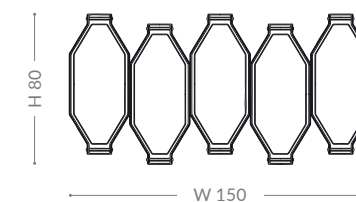

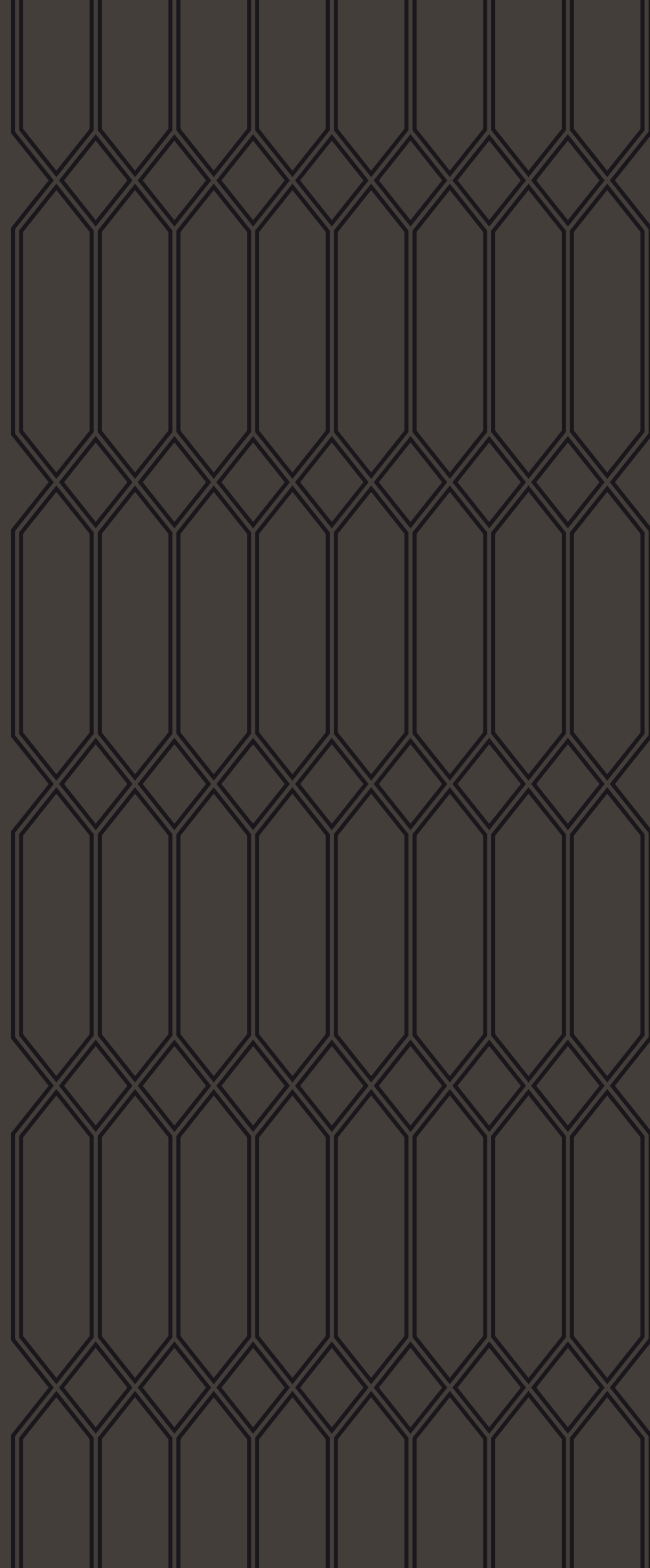

ZB

DECORATIONS



ARES

PANELING



Pannello in multistrati di legno e legno massello, rivestito in tessuto e decorato con ricamo. Disponibile come elemento singolo o come composizione modulare.

Plywood panel and solid wooden panel, covered in fabric, with quilted decoration. Available as single element or modular composition.

Панель из фанеры и панель из массива древесины, покрытая тканью и украшенная стеганой обивкой. Доступна в качестве отдельного элемента или модульной композиции.

胶合板材和实木板材，采用绗缝装饰的布艺包面。可单选或多选进行模块组合。

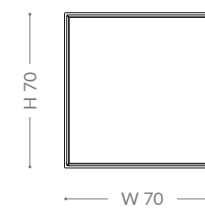

As picture: Ares paneling
In price list: Prime

Lucidatura/Finishing/Отделка/饰面
99. DOVE GREY MATT

Materiale/Material/Материал/材料
BZ 186-091 DOVE GREY

BAUHAUS

COLUMN

DECORATIONS



As picture: Bauhaus column 80
In price list: Brilliant

Lucidatura/Finishing/Отделка/饰面
57. CHOCOLATE
65. MAKASSAR
61. DIAMOND GOLD

Struttura in legno massello e multistrati di legno. Disponibile con piano laccato, in essenza di ebano makassar o noce canaletto.

Solid wood and plywood structure. Top available in lacquered wood, makassar ebony veneer or canaletto walnut veneer.

Каркас из массива дерева и фанеры. Доступные материалы верха: лакированная древесина, шпон макассарского эбена или ореха каналетто.

实木和胶合板结构。台面可选用漆木、孟加锡乌木或卡纳莱托胡桃木饰面。

CLUB

COLUMN

DECORATIONS



As picture: Club column
In price list: Brilliant

Lucidatura/Finishing/Отделка/饰面
57. CHOCOLATE
64. CANALETTO WALNUT

Struttura in legno massello e multistrati di legno. Pannello centrale disponibile in noce canaletto.

Solid wood and plywood structure. Central panel available in canaletto walnut veneer.

Каркас из массива дерева и фанеры. Центральная панель из древесины ореха каналетто.

实木和胶合板结构。中心位置板材为卡纳莱托胡桃木质地。

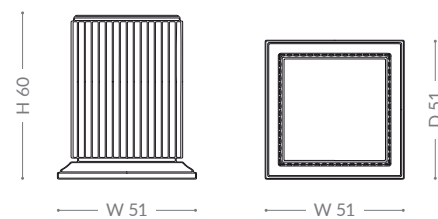

BAUHAUS 60

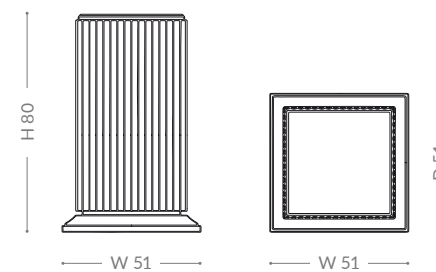

BAUHAUS 80

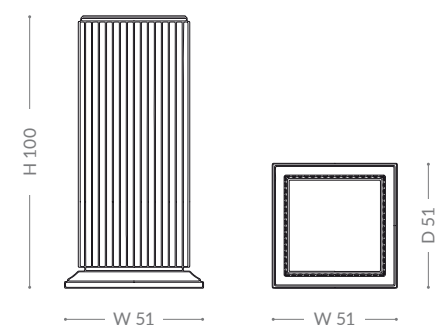

BAUHAUS 100

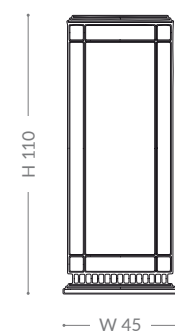

EOLO

SAIL

DECORATIONS



As picture: Eolo sail
In price list: Brilliant/Mosaic on request

Lucidatura/Finishing/Отделка/饰面
69. CANALETTO WALNUT

Parti in metallo/Metal parts/Металлическая фурнитура/金属部件
SATIN TITANIUM

Separé mobile realizzato in legno con decorazione in pelle ricamata. Decorazione con mosaico su richiesta. Disponibile in essenza di noce canaletto. Viene fornito con agganci e distanziali rotanti in metallo.

Pivoting wooden screen, decorated with quilted leather. Mosaic decoration on request. Available in canaletto walnut veneer. With metal hooks and rotating spacers.

Вращающаяся деревянная перегородка, украшенная стеганой кожей. Украшение из мозаики по заказу. Шпон ореха каналетто. Имеются металлические крючки и вращающиеся вставки.

旋转木质屏风，点缀绗缝皮革。也可根据要求镶嵌图案。卡纳莱托胡桃木饰面。配有金属钩和旋转垫片。

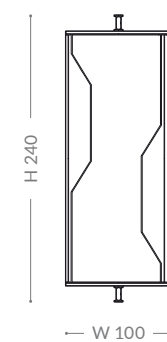

CENTRAL ELEMENT

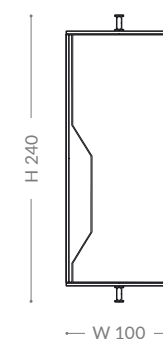

SIDE ELEMENT



D9

LEONE

WOOD SCREEN



Filtro/separé realizzato in noce canaletto e metallo. Disponibile come elemento singolo o come composizione modulare.

Screen/grid wall; canaletto walnut wood and metal structure. Available as single element or modular composition.

Ширма/перегородка. Каркас из древесины ореха канаletto и металла. Доступна в качестве отдельного элемента или модульной композиции.

屏风/格栅墙；卡纳莱托胡桃木和金属结构。可单选或多选进行模块组合。

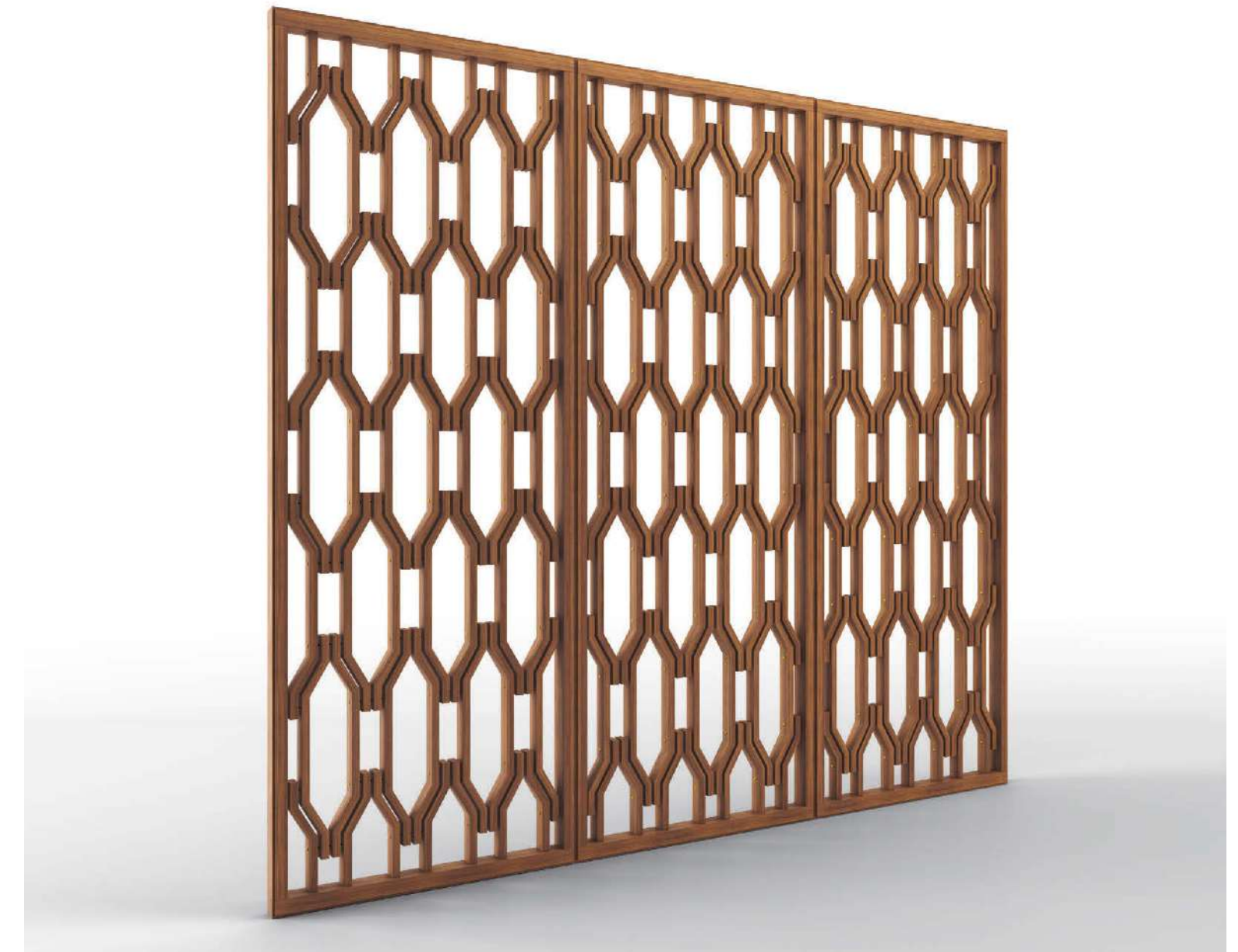

DECORATIONS

As picture: Leone wood screen
In price list: Prime

Lucidatura/Finishing/Отделка/饰面
70. CANALETTO WALNUT MATT

Parti in metallo/Metal parts/Металлическая фурнитура/金属部件
GOLD

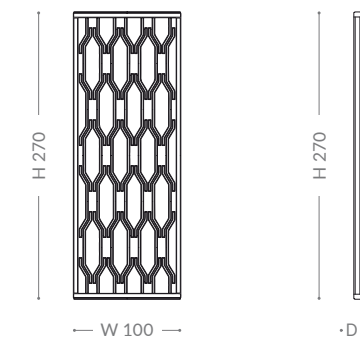

ODISSEY

SCREEN



Filtro/separé realizzato in legno massello laccato e metallo. Parte centrale decorata con logo. Disponibile come elemento singolo o come composizione modulare.

Screen/grid wall; lacquered wood and metal structure. Center decorated with logo. Available as single element or modular composition.

Ширма/перегородка. Каркас из лакированной древесины и металла. Центральная часть украшена логотипом. Доступна в качестве отдельного элемента или модульной композиции.

屏风/格栅墙；漆木和金属结构。中心位置以徽标点缀。可单选或多选进行模块组合。



DECORATIONS

As picture: Odissey screen
In price list: Brilliant

Lucidatura/Finishing/Отделка/饰面
57. CHOCOLATE

Parti in metallo/Metal parts/Металлическая фурнитура/金属部件
GOLD

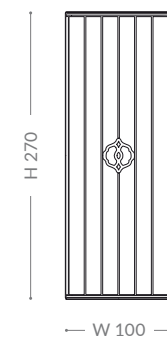

AMBASSADOR

RUG



As picture: Ambassador rug
cm 400x300
In price list: Prime

Tappeto/Rug/Ковер/地毯
TENCEL SAND

Decorazione/Decoration/
Декоративный элемент/装饰
TENCEL CARAMEL

Tappeto "hand tufted" con disegno "natura" a contrasto. Composizione: 100% Tencel. Disponibile con fondo color sabbia e disegno color caramello.

Hand tufted rug with contrasting nature pattern decoration. 100% Tencel. Available in sand color with caramel decoration.

Изготовленный вручную ковер с шитым ворсом, украшенный рисунком контрастного цвета с изображением природы. 100%-я ткань тенсел. Песочный цвет с отделкой карамельного оттенка.

手工植绒地毯，凸显对比的自然图案装饰。100% Tencel 纤维。沙色配焦糖色装饰图案。



AMBASSADOR cm 300x250



AMBASSADOR cm 400x300



AMBASSADOR cm 400x400

ASTORIA

RUG



As picture: Astoria rug
cm 400x300
In price list: Prime

Tappeto/Rug/Ковер/地毯
TENCEL DOVE GREY

Decorazione/Decoration/
Декоративный элемент/装饰
TENCEL RUST

Tappeto "hand tufted" con disegno "twin" a contrasto sul perimetro. Composizione: 100% Tencel. Disponibile con fondo color tortora e disegno color ruggine.

Hand tufted rug with contrasting "twin" pattern decoration on profile. 100% Tencel. Available in dove-grey color with rust decoration.

Изготовленный вручную ковер с шитым ворсом, украшенный двойным рисунком контрастного цвета по контуру. 100%-я ткань тенсел. Голубовато-серый цвет, отделка цвета ржавчины.

手工植绒地毯，边缘点缀对称对比色图案。100% Tencel 纤维。鸽灰色配铁锈色装饰。

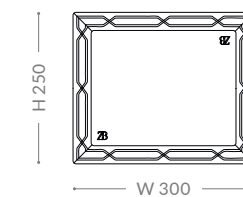

ASTORIA cm 300x250

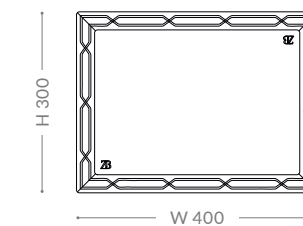

ASTORIA cm 400x300

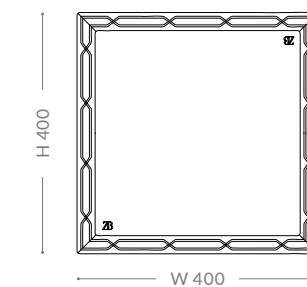

ASTORIA cm 400x400

CLUB

CARVED RUG



As picture: Club rug
cm 400x300
In price list: Prime

Tappeto/Rug/Ковер/地毯
BANANA FIBER VISCOSE IVORY

Tappeto "hand tufted" con disegno geometrico intagliato. Composizione: 100% "Banana Fiber". Disponibile in colore avorio.

Hand tufted rug with carved geometric pattern. 100% "Banana Fiber". Available in ivory color.

Изготовленный вручную ковер с шитым ворсом, украшенный резным геометрическим рисунком. 100%-е банановое волокно. Цвет слоновой кости.

手工植绒地毯，剪花几何图案。100%“香蕉纤维”。可选象牙白色。

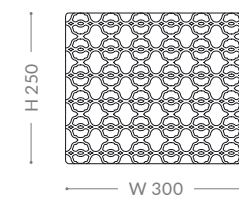

CLUB cm 300x250

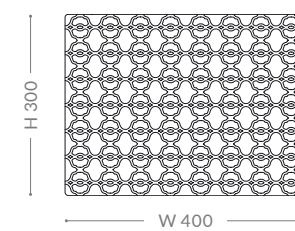

CLUB cm 400x300

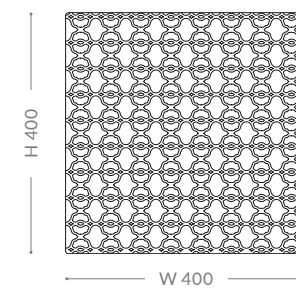

CLUB cm 400x400

OCEAN

RUG



As picture: Ocean rug
cm 400x300
In price list: Prime

Tappeto/Rug/Ковер/地毯
TENCEL SILK GREY
TENCEL PEARL GREY
TENCEL IVORY
TENCEL PLUM
TENCEL MAUVE

Tappeto "hand tufted" con disegno "astratto" a contrasto. Composizione: 100% Tencel. Disponibile con disegno in 5 colori: grigio perla, grigio seta, avorio, malva e prugna.

Hand tufted rug with contrasting abstract pattern. 100% Tencel. Available in 5 colors pattern: grey/pearl, satin grey, ivory, mauve and plum.

Изготовленный вручную ковер с шитым ворсом, украшенный абстрактным рисунком контрастного цвета. 100%-я ткань тенсел. Доступно с рисунком в 5 цветах: серый/жемчужный, сатиновый серый, цвет слоновой кости, розовато-лиловый и сливовый.

手工植绒地毯，凸显对比的抽象图案。100% Tencel 纤维。图案可选 5 种颜色：灰色/珍珠白，缎面灰色，象牙白色，淡紫色和深紫色。

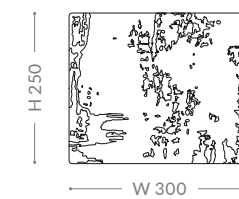

OCEAN cm 300x250

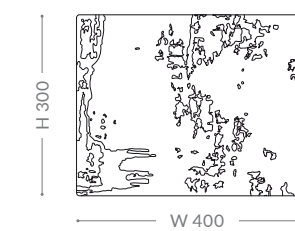

OCEAN cm 400x300

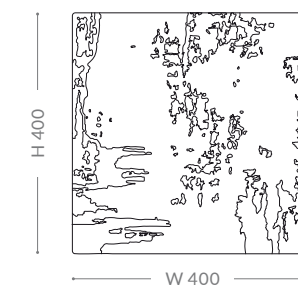

OCEAN cm 400x400

PETRUS

RUG



As picture: Petrus rug
cm 400x300
In price list: Prime

Tappeto/Rug/Ковер/地毯
WOOL IVORY
WOOL CARAMEL

Tappeto "hand tufted" con disegno geometrico a contrasto. Composizione: 100% lana "New Zealand". Disponibile con fondo avorio e disegno caramello.

Hand tufted rug with contrasting geometric pattern. 100% "New Zealand" wool. Available in ivory color with caramel decoration.

Изготовленный вручную ковер с шитым ворсом, украшенный геометрическим рисунком контрастного цвета. 100%-я новозеландская шерсть. Цвет слоновой кости с отделкой карамельного оттенка.

手工植绒地毯，凸显对比的几何图案。100% 新西兰羊毛。象牙配焦糖色装饰。

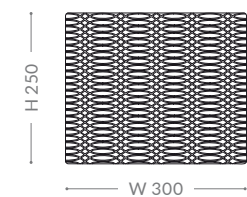

PETRUS cm 300x250

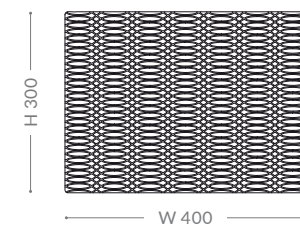

PETRUS cm 400x300

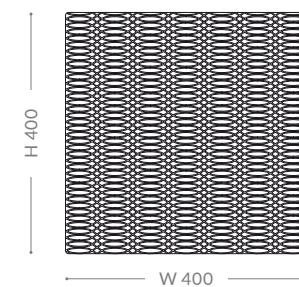

PETRUS cm 400x400

SHIRLEY

RUG

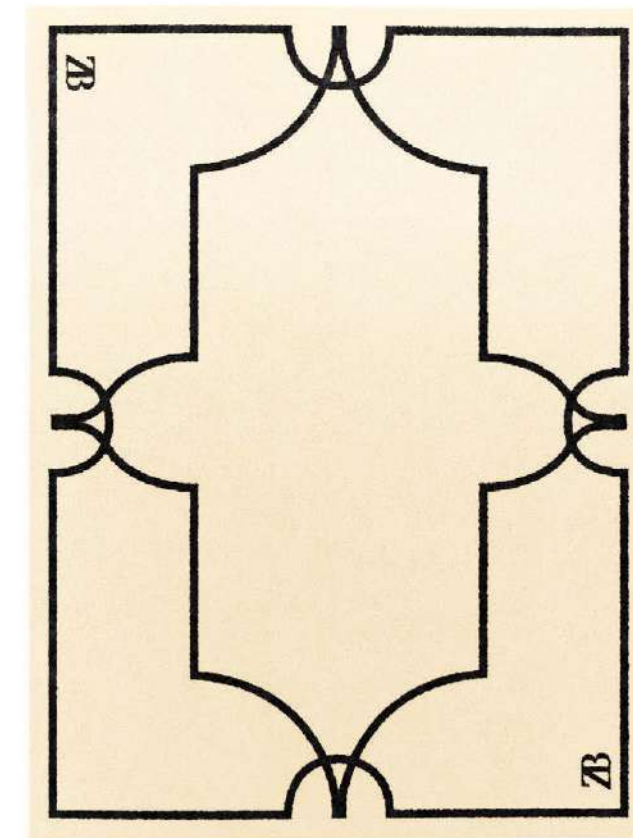

As picture: Shirley rug
cm 400x300
In price list: Prime

Tappeto/Rug/Ковер/地毯
WOOL WHITE PEARL

Decorazione/Decoration/
Декоративный элемент/装饰
TENCEL BLACK

Tappeto "hand tufted" con disegno geometrico a contrasto. Composizione: 100% lana "New Zealand" con decoro in 100% Tencel. Disponibile con fondo bianco e disegno nero intenso.

Hand tufted rug with contrasting geometric pattern. 100% "New Zealand" wool with 100% Tencel decoration. Available in ivory/white color with black decoration.

Изготовленный вручную ковер с шитым ворсом, украшенный геометрическим рисунком контрастного цвета. 100%-я новозеландская шерсть, отделка из 100%-й ткани тенсел. Цвет слоновой кости / белый с черной отделкой.

手工植绒地毯，凸显对比的几何图案。100% 新西兰木料，100% Tencel 纤维装饰。象牙白/白色配黑色装饰。

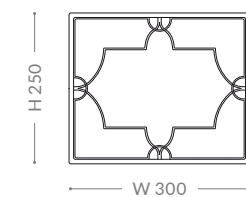

SHIRLEY cm 300x250

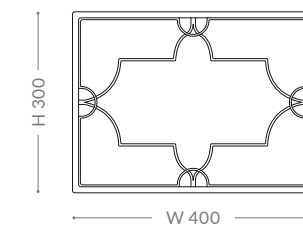

SHIRLEY cm 400x300

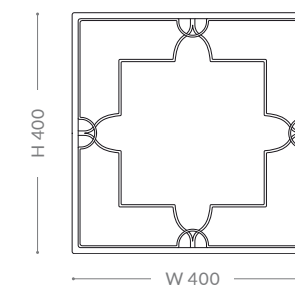

SHIRLEY cm 400x400

VERTIGO

RUG

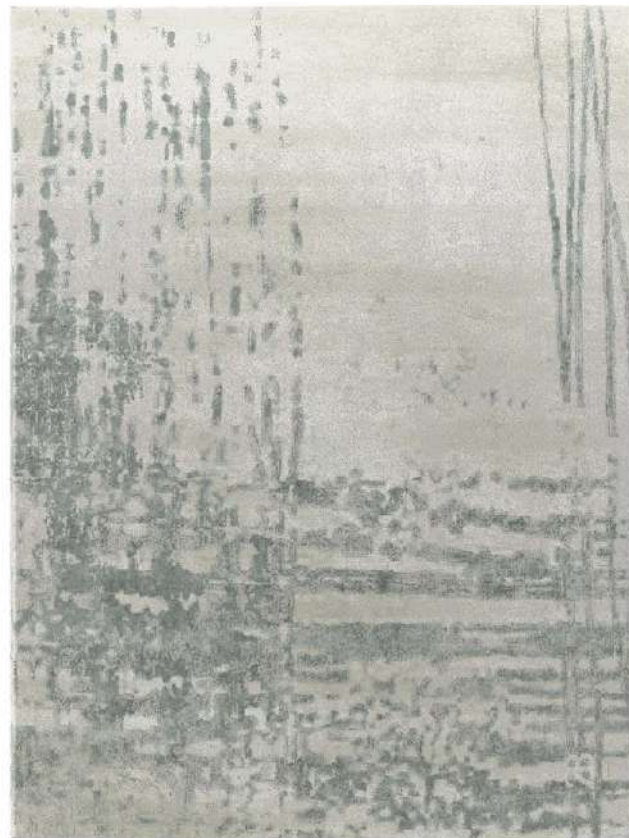

As picture: Vertigo rug
cm 400x300
In price list: Prime

Tappeto/Rug/Ковер/地毯
WOOL TIFFANY
TENCEL PEARL GREY
TENCEL SILK GREY

Tappeto "hand tufted" con disegno astratto a contrasto. Composizione: 100% lana "New Zealand" per decoro e in 100% Tencel per fondo. Disponibile con disegno in 3 colori: tiffany, grigio perla e grigio seta.

Hand tufted rug with contrasting abstract pattern. 100% Tencel with 100% "New Zealand" wool decoration. Available in 3 colors pattern: tiffany, grey/pearl and satin grey.

Изготовленный вручную ковер с шитым ворсом, украшенный абстрактным рисунком контрастного цвета. 100%-я ткань тенсел, отделка из 100%-й новозеландской шерсти. Доступно с рисунком в 3 цветах: тиффани, серый/жемчужный и сатиновый серый.

手工植绒地毯，凸显对比的抽象图案。100% Tencel 纤维，100% 新西兰羊毛装饰。图案可选 3 种颜色：蒂芙尼蓝，灰色/珍珠色和缎面灰。

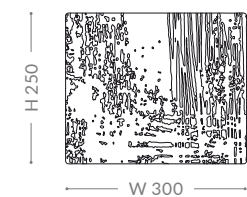

VERTIGO cm 300x250

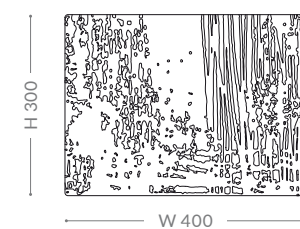

VERTIGO cm 400x300

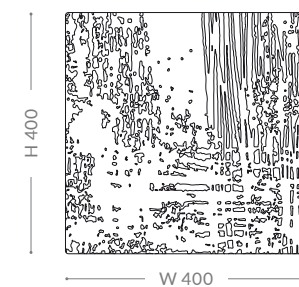

VERTIGO cm 400x400

WAVE

RUG



As picture: Wave rug
cm 400x300
In price list: Prime

Tappeto/Rug/Ковер/地毯
TENCEL DOVE GREY

Decorazione/Decoration/
Декоративный элемент/装饰
TENCEL BLUE

Tappeto "hand tufted" con disegno "twin" a contrasto. Composizione: 100% Tencel. Disponibile con fondo color tortora e disegno color blu.

Hand tufted rug with contrasting "twin" pattern decoration. 100% Tencel. Available in dove-grey color with blue decoration.

Изготовленный вручную ковер с шитым ворсом, украшенный двойным рисунком контрастного цвета. 100%-я ткань тенсел. Голубовато-серый цвет, синяя отделка.

手工植绒地毯，点缀对称对比色图案。100% Tencel 纤维。鸽灰色配蓝色装饰。

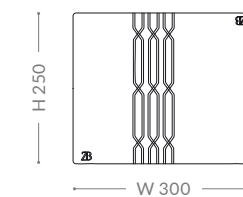

WAVE cm 300x250

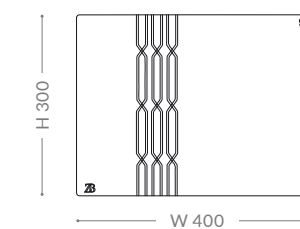

WAVE cm 400x300

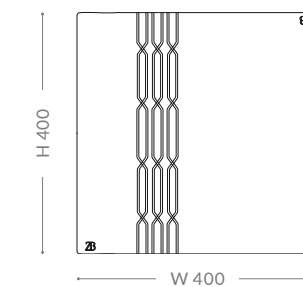

WAVE cm 400x400

ASTORIA

TABLE LAMP



LIGHTINGS

As picture: Astoria table lamp
In price list: Prime

Parti in metallo/Metal parts/Металлическая фурнитура/金属部件
SILK GOLD

Materiale/Material/Материал/材料
BZ 905-5103 LEATHER LOBSTER

Lucidatura/Finishing/Отделка/饰面
65. MAKASSAR

Struttura in metallo. Decorata con pannelli in legno laccato o in essenza di ebano makassar. Paralume in pelle ricamata.

Metal structure. Decorated with panels in lacquered wood or makassar ebony veneer. Quilted leather lampshade.

Металлический каркас. Отделка панелями из лакированной древесины или шпона макассарского эбена. Абажур из стеганой кожи.

金属结构。饰以漆木面板或孟加锡乌木饰面。绗缝皮革灯罩。

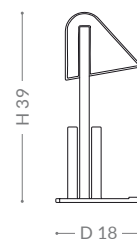
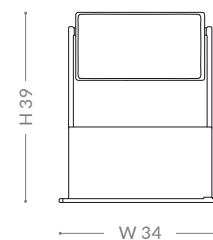

ASTORIA

WALL LAMP

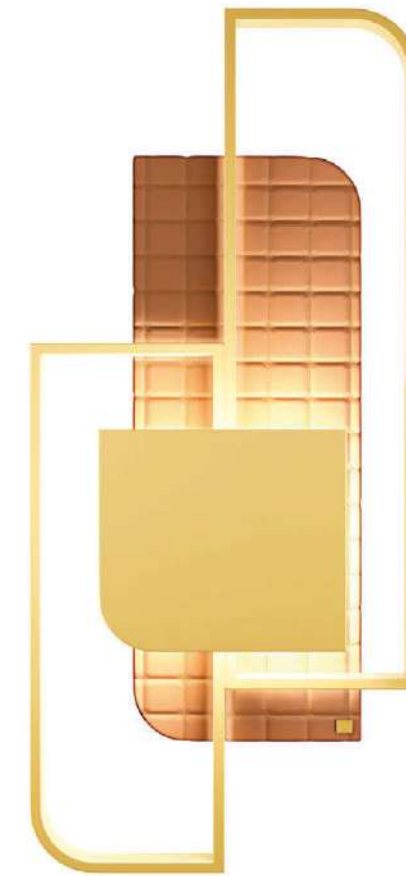

LIGHTINGS

As picture: Astoria wall lamp 100
In price list: Prime

Parti in metallo/Metal parts/Металлическая фурнитура/金属部件
SILK GOLD

Materiale/Material/Материал/材料
BZ 905-5103 LEATHER LOBSTER

Struttura in metallo. Decorata con pannello rivestito in pelle ricamata. Fornita con predisposizione attacco a parete.

Metal structure. Decorated with quilted leather panel. Equipped with wall fitting support.

Металлический каркас. Отделка в виде панели из стеганой кожи. Имеются элементы для настенного крепления.

金属结构。饰以绗缝皮革嵌条。配备墙壁安装支撑件。

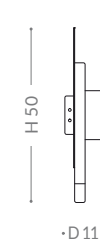
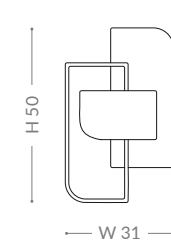

ASTORIA 50 wall lamp

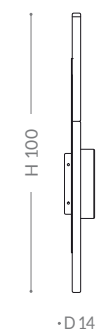
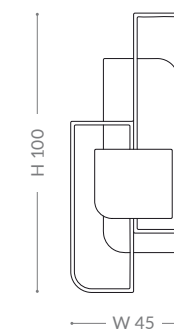

ASTORIA 100 wall lamp

BERNINI

TABLE LAMP

LIGHTINGS



As picture: Bernini table lamp
In price list: Prime

Parti in metallo/Metal parts/Металлическая фурнитура/金属部件
SILK TITANIUM

Materiale/Material/Материал/材料
BZ 905-5234 LEATHER BEIGE
BZ 184-901 PALMA BEIGE/IVORY

Struttura in metallo. Decorazione con formelle in pelle ricamata. Disponibile con paralume in tessuto.

Metal structure. Decorated with quilted leather tiles. Available with fabric lampshade.

Металлический каркас. Отделка в виде плиток из стеганой кожи. Тканевый абажур.

金属结构。块状绗缝皮革拼接点缀。布艺灯罩。

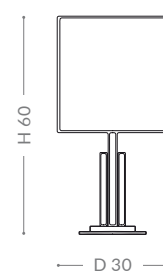
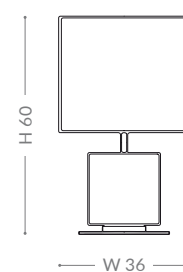

TWIN

CHANDELIER



LIGHTINGS

As picture: Twin chandelier 140
In price list: Prime

Parti in metallo/Metal parts/Металлическая фурнитура/金属部件
TITANIUM

Vetro/Glass/Стекло
изделие/玻璃
SATIN BRONZE

Decorazione del vetro/Glass decoration/Стекло декоративный элемент/玻璃饰品
WHITE

Struttura in metallo. Paralumi di forma geometrica color bronzo satinato. Decorazioni a catena in vetro rigato di Murano. Fornito con cavetti di acciaio e supporto per attacco a soffitto.

Metal structure. Geometric glass lampshades, satin bronze coloured. Murano grooved glass chain decorations. Equipped with steel wires and ceiling fitting support.

Металлический каркас. Геометрические стеклянные абажуры цвета сатирированной бронзы. Декоративные элементы цепочки из рифленого муранского стекла. Светильник имеет стальные провода и элементы для потолочного крепления.

金属结构。几何风格玻璃灯罩，缎面青铜色。慕拉诺凹纹玻璃链装饰。配有钢绳和天花板安装支撑件。

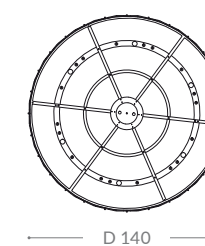
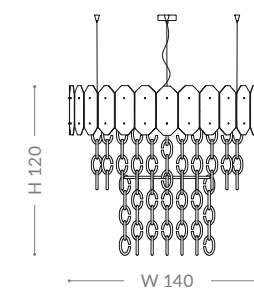

TWIN chandelier 140

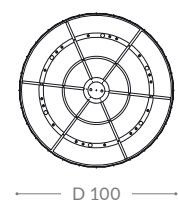
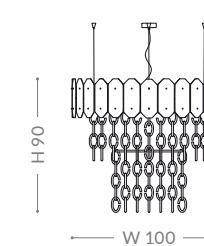

TWIN chandelier 100

TWIN

RECTANGULAR CHANDELIER



L I G H T I N G S

As picture: Twin rectangular chandelier
In price list: Prime

Parti in metallo/Metal parts/Металлическая фурнитура/金属部件
GOLD

Vetro/Glass/Стеклоанное изделие/玻璃
SATIN BRONZE

Decorazione del vetro/Glass decoration/Стеклоанный декоративный элемент/玻璃饰品
WHITE

Struttura in metallo. Paralumi di forma geometrica color bronzo satinato. Decorazioni a catena in vetro rigato di Murano. Fornito con cavetti di acciaio e supporto per attacco a soffitto.

Metal structure. Geometric glass lampshades, satin bronze coloured. Murano grooved glass chain decorations. Equipped with steel wires and ceiling fitting support.

Металлический каркас. Геометрические стеклянные абажуры цвета сатинированной бронзы. Декоративные элементы цепочки из рифленого муранского стекла. Светильник имеет стальные провода и элементы для потолочного крепления.

金属结构。几何风格玻璃灯罩，缎面青铜色。慕拉诺凹纹玻璃链装饰。配有钢绳和天花板安装支撑件。

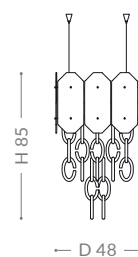
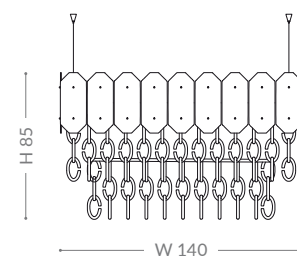

TWIN

SUSPENSION LAMP



L I G H T I N G S

As picture: Twin suspension lamp
In price list: Prime

Parti in metallo/Metal parts/Металлическая фурнитура/金属部件
GOLD

Vetro/Glass/Стеклоанное изделие/玻璃
SATIN BRONZE
SATIN WHITE

Struttura in metallo. Paralumi di forma geometrica color bronzo e bianco satinato. Fornito con cavetti di acciaio e supporto per attacco a soffitto.

Metal structure. Geometric glass lampshades, satin bronze and white colored. Equipped with steel wires and ceiling fitting support.

Металлический каркас. Стеклянные абажуры с геометрической отделкой по периметру в оттенке сатинированной бронзы и белом цвете. Светильник имеет стальные провода и элементы для потолочного крепления.

金属结构。几何轮廓玻璃灯罩，缎面青铜色和白色。配有钢绳和天花板安装支撑件。

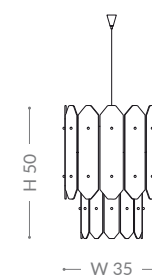

TWIN

STANDING LAMP



As picture: Twin standing lamp
In price list: Prime

Parti in metallo/Metal parts/Металлическая фурнитура/金属部件
TITANIUM

Vetro/Glass/Стеклоанное изделие/玻璃
SATIN BRONZE
SATIN WHITE

Struttura in metallo. Paralumi di forma geometrica color bronzo e bianco satinato.

Metal structure. Geometric glass lampshades, satin bronze and white colored.

Металлический каркас. Стеклоаные абажуры с геометрической отделкой в оттенке сатинированной бронзы и белом цвете.

金属结构。几何轮廓玻璃灯罩， 缎面青铜色和白色。

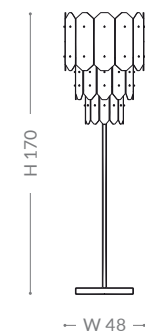

TWIN

TABLE LAMP



As picture: Twin table lamp
In price list: Prime

Parti in metallo/Metal parts/Металлическая фурнитура/金属部件
GOLD

Vetro/Glass/Стеклоанное изделие/玻璃
SATIN BRONZE
SATIN WHITE

Struttura in metallo. Paralumi di forma geometrica color bronzo e bianco satinato.

Metal structure. Geometric glass lampshades, satin bronze and white colored.

Металлический каркас. Стеклоаные абажуры с геометрической отделкой в оттенке сатинированной бронзы и белом цвете.

金属结构。几何轮廓玻璃灯罩， 缎面青铜色和白色。

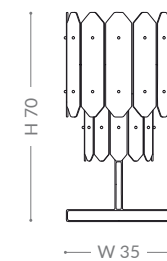

TWIN

WALL LAMP



As picture: Twin wall lamp
In price list: Prime

Parti in metallo/Metal parts/Металлическая фурнитура/金属部件
TITANIUM

Vetro/Glass/Стекло
изделие/玻璃
SATIN BRONZE

Struttura e telaio in metallo.
Paralumi color bronzo satinato.
Fornita con predisposizione
attacco a parete.

Metal structure and frame.
Satin bronze lampshades.
Equipped with wall fitting
support.

Металлические каркас
и рама. Абажуры цвета
сатирированной бронзы.
Имеются элементы для
настенного крепления.

金属结构和框架。缎面青铜灯罩。
配备墙壁安装支撑件。

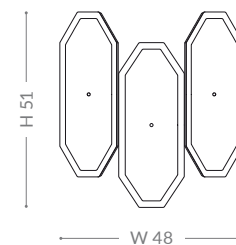

WAVE

STANDING LAMP



As picture: Wave standing lamp
In price list: Prime

Parti in metallo/Metal parts/Металлическая фурнитура/金属部件
SILK GOLD

Materiale/Material/Материал/材料
BZ 905-5234 LEATHER BEIGE
BZ 184-901 PALMA BEIGE/IVORY

Struttura in metallo.
Decorazioni in metallo curvato
e formelle in pelle ricamata.
Disponibile con paralume in
tessuto.

Metal structure. Curved metal
decoration and quilted leather
panels. Available with fabric
lampshade.

Металлический каркас.
Резная металлическая
отделка и панели из стеганой
кожи. Тканевый абажур.

金属结构。曲线金属装饰，绗缝皮革嵌条。布艺灯罩。

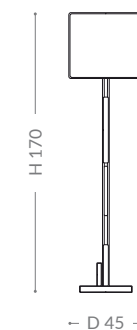
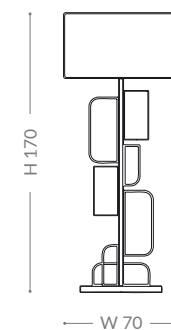

WAVE

TABLE LAMP

L I G H T I N G S



As picture: Wave table lamp
In price list: Prime

Parti in metallo/Metal parts/Металлическая фурнитура/金属部件
SILK GOLD

Materiale/Material/Материал/材料
BZ 905-5234 LEATHER BEIGE
BZ 184-901 PALMA BEIGE/IVORY

Struttura in metallo.
Decorazioni in metallo curvato
e formelle in pelle ricamata.
Disponibile con paralume in
tessuto.

Metal structure. Curved metal
decoration and quilted leather
panels. Available with fabric
lampshade.

Металлический каркас.
Резная металлическая
отделка и панели из стеганой
кожи. Тканевый абажур.

金属结构。曲线金属装饰，绗缝皮革嵌条。布艺灯罩。

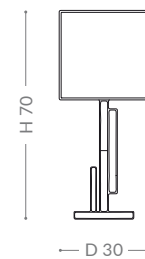
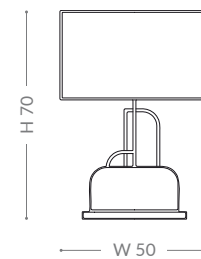

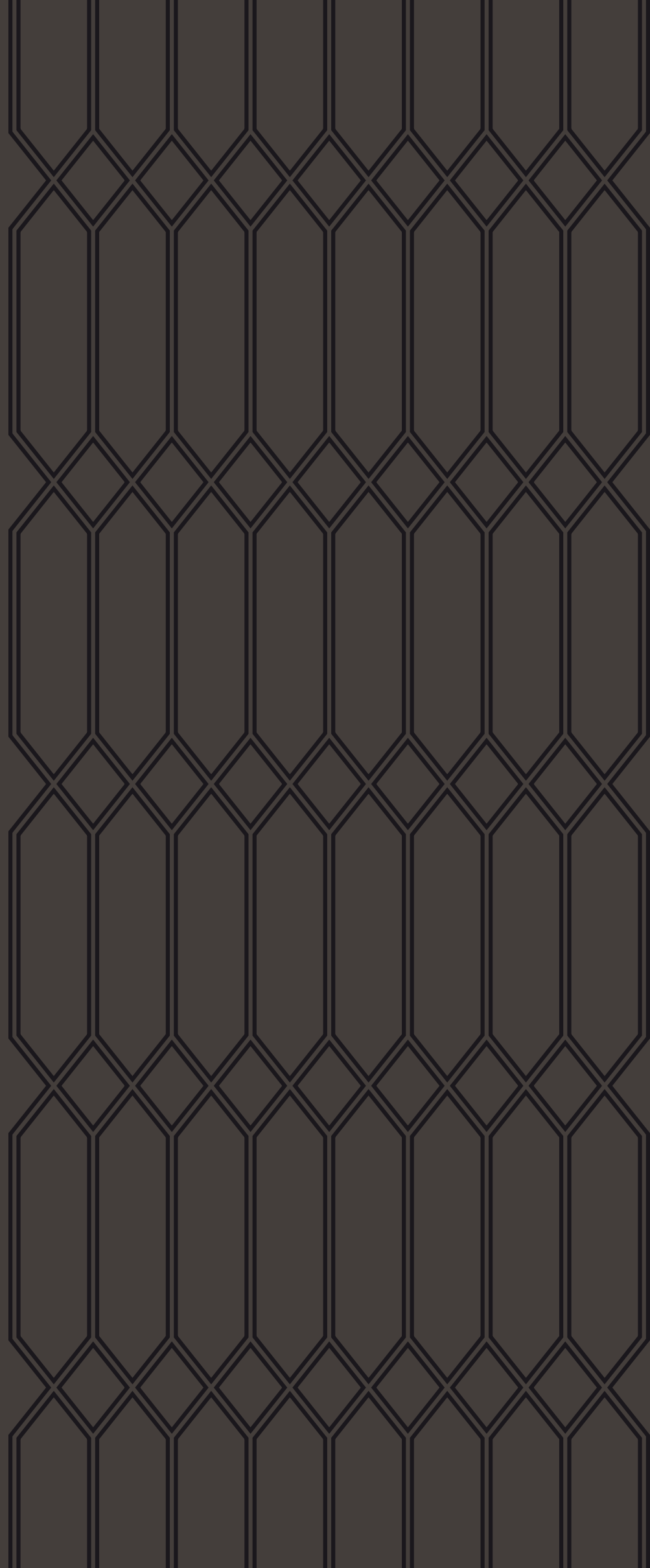

ZB

SUMMARY



SOFAS



AMAZON SOFA
Vol. 1 - pag. 22



AMBASSADOR SOFA
Vol. 1 - pag. 24



AMBASSADOR MODULAR SOFA
Vol. 1 - pag. 26



BABYLON SOFA
Vol. 1 - pag. 30



GATSBY SOFA
Vol. 1 - pag. 56



GIASONE SOFA
Vol. 1 - pag. 58



GIASONE MODULAR SOFA
Vol. 1 - pag. 61



GORDON SOFA
Vol. 1 - pag. 64



BARRYMORE SOFA
Vol. 1 - pag. 32



BARRYMORE MODULAR SOFA
Vol. 1 - pag. 34



BAUHAUS SOFA
Vol. 1 - pag. 36



BAUHAUS SOFA
Vol. 1 - pag. 38



GORDON MODULAR SOFA
Vol. 1 - pag. 67



HARMONY SOFA
Vol. 1 - pag. 70



HEMINGWAY SOFA
Vol. 1 - pag. 72



IPAZIA SOFA
Vol. 1 - pag. 74



CLUB SOFA
Vol. 1 - pag. 40



COCÒ SOFA
Vol. 1 - pag. 42



DAVIS SOFA
Vol. 1 - pag. 44



DAVIS MODULAR SOFA
Vol. 1 - pag. 46



KING SOFA
Vol. 1 - pag. 76



LEGEND SOFA
Vol. 1 - pag. 78



LEGEND SOFA
Vol. 1 - pag. 80



POSEIDON SOFA
Vol. 1 - pag. 82



EMPERADOR SOFA
Vol. 1 - pag. 48



EMPERADOR SOFA
Vol. 1 - pag. 50



FLY SOFA
Vol. 1 - pag. 52



GATSBY SOFA
Vol. 1 - pag. 54



POSEIDON SOFA
Vol. 1 - pag. 84



VERTIGO SOFA
Vol. 1 - pag. 86



VERTIGO SOFA
Vol. 1 - pag. 88



WAVE SOFA
Vol. 1 - pag. 90



WAVE MODULAR SOFA
Vol. 1 - pag. 93



CLUB WIDE ARMCHAIR
Vol. 1 - pag. 114



DAVIS ARMCHAIR
Vol. 1 - pag. 116



DAVIS SMALL ARMCHAIR
Vol. 1 - pag. 118



FLOWER ARMCHAIR
Vol. 1 - pag. 120

ARMCHAIRS



FLY ARMCHAIR
Vol. 1 - pag. 122



IPAZIA ARMCHAIR
Vol. 1 - pag. 124



IPAZIA ARMCHAIR
Vol. 1 - pag. 126



KING ARMCHAIR
Vol. 1 - pag. 128



ARDEA ARMCHAIR
Vol. 1 - pag. 98



ARDEA ARMCHAIR
Vol. 1 - pag. 100



ARIEL ARMCHAIR
Vol. 1 - pag. 102



AURORA ARMCHAIR
Vol. 1 - pag. 104



LEGEND ARMCHAIR
Vol. 1 - pag. 130



LEGEND ARMCHAIR
Vol. 1 - pag. 132



LOPEZ ARMCHAIR
Vol. 1 - pag. 134



MARYLOU ARMCHAIR
Vol. 1 - pag. 136



BAUHAUS ARMCHAIR
Vol. 1 - pag. 106



BEVERLY ARMCHAIR
Vol. 1 - pag. 108



BEVERLY ARMCHAIR
Vol. 1 - pag. 110



CLUB ARMCHAIR
Vol. 1 - pag. 112



MARYLOU ARMCHAIR
Vol. 1 - pag. 138



PANDORA ARMCHAIR
Vol. 1 - pag. 140



PANDORA ARMCHAIR
Vol. 1 - pag. 142



WALLY ARMCHAIR
Vol. 1 - pag. 144

DORMEUSE



COLETTE DORMEUSE
Vol. 1 - pag. 148



GERRIT DORMEUSE
Vol. 1 - pag. 150



GORDON DORMEUSE
Vol. 1 - pag. 152



LEGEND DORMEUSE
Vol. 1 - pag. 154

POUFS



ADAM POUF
Vol. 1 - pag. 158



BELLE POUF
Vol. 1 - pag. 159



FLY POUF
Vol. 1 - pag. 160



FLY CAPITONNÉ POUF
Vol. 1 - pag. 161



KIMBERLY POUF
Vol. 1 - pag. 162



MOON WALT POUF
Vol. 1 - pag. 163

SOFA TABLES



ALCESTE SIDE TABLE
Vol. 1 - pag. 166



CLUB CENTRAL TABLE
Vol. 1 - pag. 167



CLUB SIDE TABLE
Vol. 1 - pag. 168



DEA SIDE TABLE
Vol. 1 - pag. 169



DEA TWIN SET
Vol. 1 - pag. 170



ESEDRA SIDE TABLE
Vol. 1 - pag. 171



ESEDRA CENTRAL TABLE SET
Vol. 1 - pag. 172



EXPERIA CENTRAL TABLE
Vol. 1 - pag. 173



FLY CENTRAL TABLE
Vol. 1 - pag. 174



FLY SIDE TABLE
Vol. 1 - pag. 175



GREY TABLE SET
Vol. 1 - pag. 176



HECTOR SIDE TABLE
Vol. 1 - pag. 177



MUMFORD CENTRAL TABLE
Vol. 1 - pag. 178



MUMFORD SIDE TABLE
Vol. 1 - pag. 179



NEW LINE RECTANGULAR CENTRAL TABLE
Vol. 1 - pag. 180



NEW LINE SQUARE CENTRAL TABLE
Vol. 1 - pag. 181



NEW LINE SIDE TABLE
Vol. 1 - pag. 182



NEW LINE SIDE TABLE
Vol. 1 - pag. 183



OLIVER CENTRAL TABLE
Vol. 1 - pag. 184



OLIVER SIDE TABLE
Vol. 1 - pag. 185



TRITON ROUND TABLE 45
Vol. 1 - pag. 199



TRITON ROUND TABLE 60
Vol. 1 - pag. 200



TRITON COURTESY TABLE
Vol. 1 - pag. 201



TULIP ROUND TABLE
Vol. 1 - pag. 202



OLIVER COURTESY TABLE
Vol. 1 - pag. 186



OTTO CENTRAL TABLE
Vol. 1 - pag. 187



OTTO CENTRAL TABLE
Vol. 1 - pag. 188



RUPERT CENTRAL TABLE
Vol. 1 - pag. 189



TULIP SIDE TABLE 35+45
Vol. 1 - pag. 203



TULIP TRIS SET
Vol. 1 - pag. 204



WAVE CENTRAL TABLE
Vol. 1 - pag. 205



RUPERT CENTRAL TABLE
Vol. 1 - pag. 190



RUPERT ROUND TABLE
Vol. 1 - pag. 191



RUPERT ROUND TABLE
Vol. 1 - pag. 192



STAN CENTRAL TABLE
Vol. 1 - pag. 193



STAN COURTESY TABLE
Vol. 1 - pag. 194



STAN SIDE TABLE
Vol. 1 - pag. 195



TRITON CENTRAL TABLE
Vol. 1 - pag. 196



TRITON SQUARE TABLE
Vol. 1 - pag. 198

DINING TABLES



BOSTON RECTANGULAR DINING TABLE
Vol. 1 - pag. 208



BOSTONWIDE RECTANGULAR DINING TABLE
Vol. 1 - pag. 210



BOSTON ROUND DINING TABLE
Vol. 1 - pag. 212



GILLON EXTENSIBLE DINING TABLE
Vol. 1 - pag. 214



PETRUS RECTANGULAR DINING TABLE
Vol. 1 - pag. 240



PETRUS ROUND DINING TABLE
Vol. 1 - pag. 242



PETRUS ROUND DINING TABLE
Vol. 1 - pag. 244



WANDA RECTANGULAR DINING TABLE
Vol. 1 - pag. 246



MANHATTAN RECTANGULAR DINING TABLE
Vol. 1 - pag. 216



METROPOLIS ELLIPTICAL DINING TABLE
Vol. 1 - pag. 218



METROPOLISWIDE ELLIPTICAL DINING TABLE
Vol. 1 - pag. 220



METROPOLIS ROUND DINING TABLE
Vol. 1 - pag. 222

DINING CHAIRS



MILLENIUM ROUND DINING TABLE
Vol. 1 - pag. 224



MILLENIUM RECTANGULAR DINING TABLE
Vol. 1 - pag. 226



OMEGA CRYSTAL RECTANGULAR DINING TABLE
Vol. 1 - pag. 228



OMEGA EBONY RECTANGULAR DINING TABLE
Vol. 1 - pag. 230



ARISTON DINING CHAIR
Vol. 1 - pag. 250



ARISTON DINING CHAIR
Vol. 1 - pag. 251



CAPRICE DINING ARMCHAIR
Vol. 1 - pag. 252



CAPRICE DINING CHAIR
Vol. 1 - pag. 253



OMEGA CRYSTAL ROUND DINING TABLE
Vol. 1 - pag. 232



OMEGA EBONY ROUND DINING TABLE
Vol. 1 - pag. 234



ORION ROUND DINING TABLE
Vol. 1 - pag. 236



ORION RECTANGULAR DINING TABLE
Vol. 1 - pag. 238



CELINE DINING ARMCHAIR
Vol. 1 - pag. 254



CELINE DINING CHAIR
Vol. 1 - pag. 255



DILETTA DINING ARMCHAIR
Vol. 1 - pag. 256



DILETTA DINING ARMCHAIR
Vol. 1 - pag. 257

BAR COUNTERS AND STOOLS



DILETTA DINING CHAIR
Vol. 1 - pag. 258



DILETTA DINING CHAIR
Vol. 1 - pag. 259



GRETA DINING ARMCHAIR
Vol. 1 - pag. 260



GRETA DINING CHAIR
Vol. 1 - pag. 261



DIONISO BAR COUNTER
Vol. 1 - pag. 276



LEGEND BAR COUNTER
Vol. 1 - pag. 278



ARISTON BAR STOOL
Vol. 1 - pag. 280



FLOWER BAR STOOL
Vol. 1 - pag. 281



MARYBELL DINING ARMCHAIR
Vol. 1 - pag. 262



MARYBELL DINING ARMCHAIR
Vol. 1 - pag. 263



OPHELIA DINING ARMCHAIR
Vol. 1 - pag. 264



OPHELIA DINING ARMCHAIR
Vol. 1 - pag. 265



OPHELIA BAR STOOL
Vol. 1 - pag. 282



OPHELIA BAR TABLE
Vol. 1 - pag. 283



OPHELIA DINING CHAIR
Vol. 1 - pag. 266



OPHELIA DINING CHAIR
Vol. 1 - pag. 267



OPIUM DINING ARMCHAIR
Vol. 1 - pag. 268



OPIUM DINING CHAIR
Vol. 1 - pag. 269



SUNRISE DINING ARMCHAIR
Vol. 1 - pag. 270



SUNRISE DINING CHAIR
Vol. 1 - pag. 271



VERSAILLE DINING ARMCHAIR
Vol. 1 - pag. 272



VERSAILLE DINING CHAIR
Vol. 1 - pag. 273

BEDS



APOLLO BED
Vol. 2 - pag. 22



BERNINI BED
Vol. 2 - pag. 24



BERNINI WIDE BED
Vol. 2 - pag. 26



BERNINI XYLO BED
Vol. 2 - pag. 28



BERNINI XYLOWIDE BED
Vol. 2 - pag. 30



CLEO BED
Vol. 2 - pag. 32



HERMES BED
Vol. 2 - pag. 34



HERMITAGE BED
Vol. 2 - pag. 36



HORIZON BED
Vol. 2 - pag. 38



JUNO BED
Vol. 2 - pag. 40



KING BED
Vol. 2 - pag. 42



MADISON BED
Vol. 2 - pag. 44



OCEAN BED
Vol. 2 - pag. 46



OVERWALL BED
Vol. 2 - pag. 48

BEDSIDE TABLES



BUSTER BEDSIDE TABLE
Vol. 2 - pag. 52



CLARK BEDSIDE TABLE
Vol. 2 - pag. 53



ELYPSE BEDSIDE TABLE
Vol. 2 - pag. 54



ELYPSE BEDSIDE TABLE
Vol. 2 - pag. 55



GLENN BEDSIDE TABLE
Vol. 2 - pag. 56



HERMES BEDSIDE TABLE
Vol. 2 - pag. 57



HORIZON BEDSIDE TABLE
Vol. 2 - pag. 58



OCEAN I BEDSIDE TABLE
Vol. 2 - pag. 59



OCEAN II BEDSIDE TABLE
Vol. 2 - pag. 60



REMINGTON BEDSIDE TABLE
Vol. 2 - pag. 61



STUART BEDSIDE TABLE
Vol. 2 - pag. 62



STUART BEDSIDE TABLE
Vol. 2 - pag. 63

CHEST OF DRAWERS



BUSTER CHEST OF DRAWERS
Vol. 2 - pag. 66



BUSTER CHEST OF DRAWERS
Vol. 2 - pag. 68



DEANNA CHEST OF DRAWERS
Vol. 2 - pag. 70



GLENN CHEST OF DRAWERS
Vol. 2 - pag. 72



REMINGTON CHEST OF DRAWERS
Vol. 2 - pag. 74

DRESSING TABLES



EMANUELLE DRESSING TABLE
Vol. 2 - pag. 78



KIMBERLY DRESSING TABLE
Vol. 2 - pag. 80



KIMBERLY POUF
Vol. 2 - pag. 81



MADEMOISELLE DRESSING TABLE
Vol. 2 - pag. 82



MADEMOISELLE CHAIR
Vol. 2 - pag. 84



VIVIEN DRESSING TABLE
Vol. 2 - pag. 86



MOON WALT POUF
Vol. 2 - pag. 87

BENCHES



ADAM BENCH
Vol. 2 - pag. 90



BLANCA BENCH 100
Vol. 2 - pag. 91



BLANCA BENCH 160
Vol. 2 - pag. 92



FAYR BENCH
Vol. 2 - pag. 93



FLY BENCH
Vol. 2 - pag. 94



GREY BENCH
Vol. 2 - pag. 95



HERMES BENCH
Vol. 2 - pag. 96



MOON WALT BENCH
Vol. 2 - pag. 97

CONSOLLES



KIMBERLY CONSOLLE
Vol. 2 - pag. 100



KIMBERLY CONSOLLE SMALL
Vol. 2 - pag. 102



LUCINDA CONSOLLE
Vol. 2 - pag. 104



LUCINDA CONSOLLE
Vol. 2 - pag. 106



RANDOLPH CONSOLLE
Vol. 2 - pag. 108



SWING BACKSOFA CONSOLLE
Vol. 2 - pag. 110



SWING CONSOLLE LARGE
Vol. 2 - pag. 112



SWING CONSOLLE SMALL
Vol. 2 - pag. 114



WANDA CONSOLLE
Vol. 2 - pag. 116



WANDA CONSOLLE SMALL
Vol. 2 - pag. 118

SIDEBOARDS



CONCORDE SIDEBOARD
Vol. 2 - pag. 122



CONCORDE SIDEBOARD WIDE
Vol. 2 - pag. 124



DEANNA SIDEBOARD 9 DRAWERS
Vol. 2 - pag. 126



DEANNA SIDEBOARD 3 DRAWERS
Vol. 2 - pag. 128



DUKE SIDEBOARD
Vol. 2 - pag. 130



FIORILE SIDEBOARD
Vol. 2 - pag. 132



GLENN SIDEBOARD HIGH
Vol. 2 - pag. 134



GLENN SIDEBOARD LOW
Vol. 2 - pag. 136



REMINGTON SIDEBOARD
Vol. 2 - pag. 138

TV UNITS



CONCORDE TV FRAME
Vol. 2 - pag. 142



CONCORDE TV CABINET
Vol. 2 - pag. 144



DUCA TV FRAME
Vol. 2 - pag. 146



DUCA TV CABINET
Vol. 2 - pag. 148



DUKE TV FRAME
Vol. 2 - pag. 150



DUKE TV CABINET
Vol. 2 - pag. 152



FIORILE TV CABINET
Vol. 2 - pag. 154



REMINGTON TV FRAME
Vol. 2 - pag. 156



REMINGTON TV CABINET
Vol. 2 - pag. 158

DISPLAY CABINETS



CONCORDE DISPLAY CABINET
Vol. 2 - pag. 162



ESTELLE DISPLAY CABINET
Vol. 2 - pag. 164



ESTELLE DISPLAY CABINET
Vol. 2 - pag. 166



FRITZ DISPLAY CABINET
Vol. 2 - pag. 168



KIMBERLY DISPLAY CABINET
Vol. 2 - pag. 170



VENUS DISPLAY CABINET
Vol. 2 - pag. 172

BOOKSHELVES



CLARK BOOKSHELF
Vol. 2 - pag. 176



DAFNE BOOKSHELF
Vol. 2 - pag. 178



JADE BOOKSHELF
Vol. 2 - pag. 180



SIRIO BOOKSHELF
Vol. 2 - pag. 182

CABINETS



CONCORDE WARDROBE CABINET
Vol. 2 - pag. 186



CONCORDE WINE CABINET
Vol. 2 - pag. 188



DEDALO BACK SOFA CABINET
Vol. 2 - pag. 191



DEDALO CABINET
Vol. 2 - pag. 192



RICHELIEU BAR CABINET
Vol. 2 - pag. 206



RICHELIEU GAMING CABINET
Vol. 2 - pag. 208



VENUS CABINET
Vol. 2 - pag. 210



DEDALO DUAL UNIT
Vol. 2 - pag. 193



DEDALO FREE STANDING PARTITION 1
Vol. 2 - pag. 194



DEDALO FREE STANDING PARTITION 2
Vol. 2 - pag. 195



DEDALO LIBRARY
Vol. 2 - pag. 196

DESKS



DEDALO OFFICE COMPOSITION
Vol. 2 - pag. 197



DEDALO SIDEBOARD
Vol. 2 - pag. 198



DEDALO TV CABINET 1
Vol. 2 - pag. 199



DEDALO TV COMPOSITION 1
Vol. 2 - pag. 200



ASTORIA DESK
Vol. 2 - pag. 214



CLARK DESK
Vol. 2 - pag. 216



LEGEND DESK
Vol. 2 - pag. 218



SQUARE DESK
Vol. 2 - pag. 220



DEDALO TV COMPOSITION 2
Vol. 2 - pag. 201

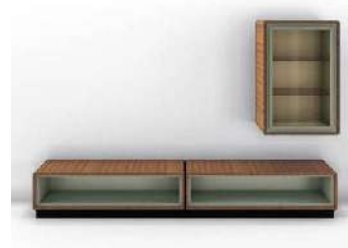

DEDALO TV COMPOSITION 3
Vol. 2 - pag. 202



DEDALO WALL COMPOSITION
Vol. 2 - pag. 203



FRITZ BAR CABINET
Vol. 2 - pag. 204

OFFICE CHAIRS



ATLANTIS OFFICE CHAIR
Vol. 2 - pag. 224



COMET FRONT DESK CHAIR
Vol. 2 - pag. 225



COMET OFFICE CHAIR
Vol. 2 - pag. 226



LONDON OFFICE CHAIR
Vol. 2 - pag. 227



REGENT FRONT DESK CHAIR
Vol. 2 - pag. 228



REGENT OFFICE CHAIR
Vol. 2 - pag. 229

MIRRORS

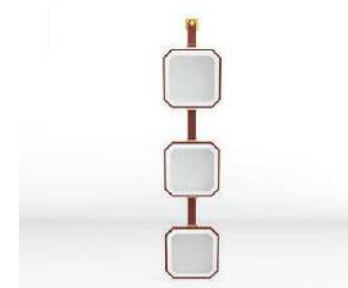

ARTEMIDE MIRROR
Vol. 2 - pag. 232



CONSTANCE MIRROR
Vol. 2 - pag. 233



ETIENNE MIRROR
Vol. 2 - pag. 234

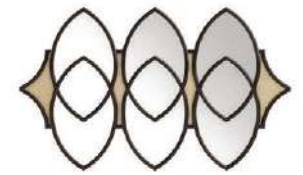

FLYNN MIRROR
Vol. 2 - pag. 235



IKE MIRROR
Vol. 2 - pag. 236



JUPITER MIRROR
Vol. 2 - pag. 237



OSIRIS RECTANGULAR MIRROR
Vol. 2 - pag. 238



OSIRIS ROUND MIRROR
Vol. 2 - pag. 239



SHIRLEY MIRROR
Vol. 2 - pag. 240



TWIN MIRROR
Vol. 2 - pag. 241



TWIN MIRRORS COMPOSITION 1
Vol. 2 - pag. 242



TWIN MIRRORS COMPOSITION 2
Vol. 2 - pag. 243

DECORATIONS



ARES PANELING
Vol. 2 - pag. 246



BAUHAUS COLUMN
Vol. 2 - pag. 248



CLUB COLUMN
Vol. 2 - pag. 249



EOLO SAIL
Vol. 2 - pag. 250



LEONE WOOD SCREEN
Vol. 2 - pag. 252



ODISSEY SCREEN
Vol. 2 - pag. 254

RUGS



AMBASSADOR RUG
Vol. 2 - pag. 258



ASTORIA RUG
Vol. 2 - pag. 259



CLUB CARVED RUG
Vol. 2 - pag. 260



OCEAN RUG
Vol. 2 - pag. 261



PETRUS RUG
Vol. 2 - pag. 262

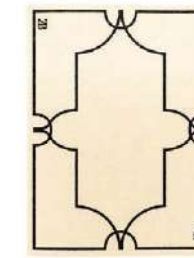

SHIRLEY RUG
Vol. 2 - pag. 263



VERTIGO RUG
Vol. 2 - pag. 264

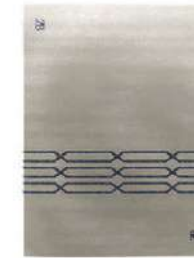

WAVE RUG
Vol. 2 - pag. 265

LIGHTINGS



ASTORIA TABLE LAMP
Vol. 2 - pag. 268



ASTORIA WALL LAMP
Vol. 2 - pag. 269



BERNINI TABLE LAMP
Vol. 2 - pag. 270



TWIN CHANDELIER
Vol. 2 - pag. 271



TWIN RECTANGULAR CHANDELIER
Vol. 2 - pag. 272



TWIN SUSPENSION LAMP
Vol. 2 - pag. 273



TWIN STANDING LAMP
Vol. 2 - pag. 274



TWIN TABLE LAMP
Vol. 2 - pag. 275



TWIN WALL LAMP
Vol. 2 - pag. 276



WAVE STANDING LAMP
Vol. 2 - pag. 277



WAVE TABLE LAMP
Vol. 2 - pag. 278

CONTACT US

BRUNO ZAMPA s.r.l.

Via Crosaron, 23
37053 Cerea
Verona - Italy
T. +39 0442 80594
F. +39 0442 329534

GALLERY

Via Calcara, 68/70
37053 Cerea
Verona - Italy

info@brunozampa.it
www.brunozampa.it

Produced by
©Bruno Zampa s.r.l. - All rights reserved

PHOTO Lighthug Design s.r.l. and Place Design e Rendering s.r.l.s.

GRAPHIC DESIGN Deepartweb s.r.l.

PRINTING Grafiche Stella s.r.l.

All products in this catalogue are 100% Made in Italy.

All colors of leather or fabric's covers, lacquered wood and rugs can't be considered as color references.

The dimensions of products are subject to change according to the instructions of the catalogue.

Any reproduction, representation or modification, in full or partly, is expressly prohibited.



www.brunozampa.it